

# CLM HD8

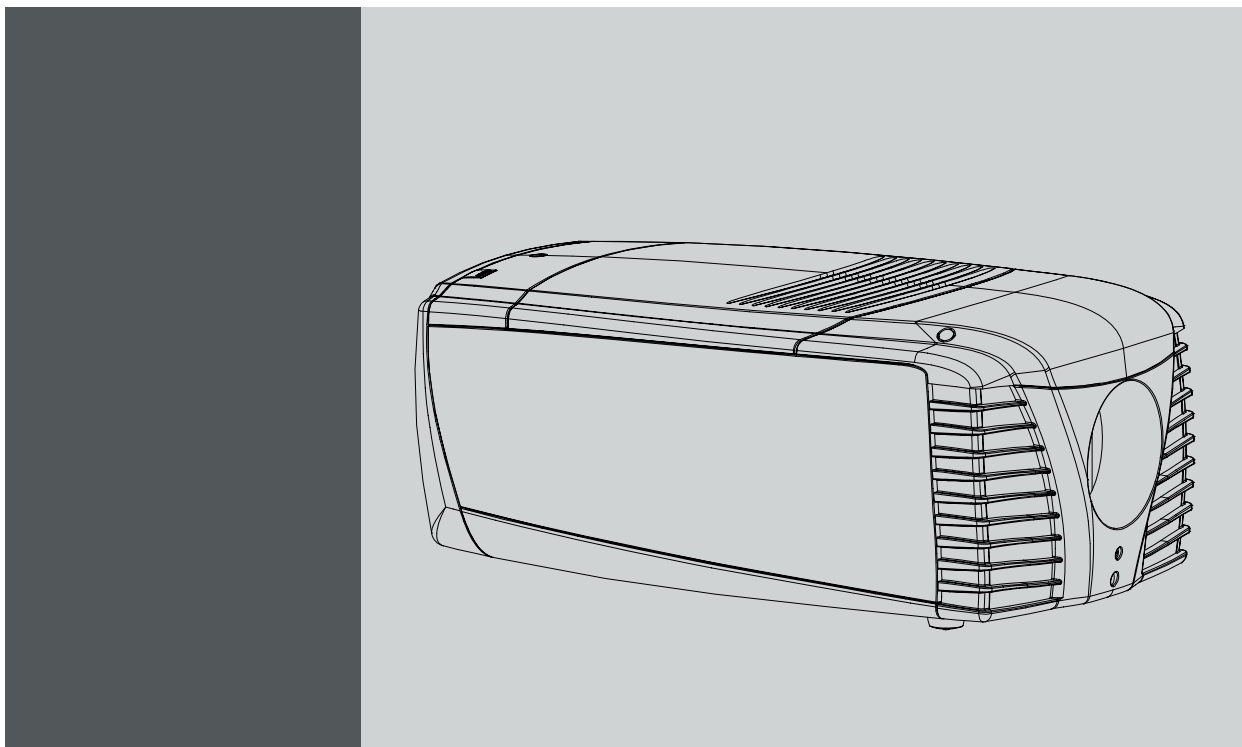

## User guide

R9050130  
R90501301  
R90501305

**Barco nv Events**

Noordlaan 5, B-8520 Kurne

Phone: +32 56.36.82.11

Fax: +32 56.36.88.24

E-mail: [sales.events@barco.com](mailto:sales.events@barco.com)

Visit us at the web: [www.barco.com](http://www.barco.com)

## Changes

Barco provides this manual 'as is' without warranty of any kind, either expressed or implied, including but not limited to the implied warranties or merchantability and fitness for a particular purpose. Barco may make improvements and/or changes to the product(s) and/or the program(s) described in this publication at any time without notice.

This publication could contain technical inaccuracies or typographical errors. Changes are periodically made to the information in this publication; these changes are incorporated in new editions of this publication.

## Copyright ©

All rights reserved. No part of this document may be copied, reproduced or translated. It shall not otherwise be recorded, transmitted or stored in a retrieval system without the prior written consent of Barco.

## Trademarks

Brand and product names mentioned in this manual may be trademarks, registered trademarks or copyrights of their respective holders. All brand and product names mentioned in this manual serve as comments or examples and are not to be understood as advertising for the products or their manufacturers.

## Federal Communications Commission (FCC Statement)

This equipment has been tested and found to comply with the limits for a class A digital device, pursuant to Part 15 of the FCC rules. These limits are designed to provide reasonable protection against harmful interference when the equipment is operated in a commercial environment. This equipment generates, uses, and can radiate radio frequency energy and, if not installed and used in accordance with the instruction manual, may cause harmful interference to radio communications. Operation of this equipment in a residential area may cause harmful interference, in which case the user will be responsible for correcting any interference at his own expense

## EN55022/CISPR22 Class A ITE (Information Technology Equipment)

Class A ITE is a category of all other ITE which satisfies the class A ITE limits but not the class B ITE limits. Such equipment should not be restricted in its sale but the following warning shall be included in the instructions for use:

**Warning :** This is a class A product. In a domestic environment this product may cause radio interference in which case the user may be required to take adequate measures.

## Guarantee and Compensation

Barco provides a guarantee relating to perfect manufacturing as part of the legally stipulated terms of guarantee. On receipt, the purchaser must immediately inspect all delivered goods for damage incurred during transport, as well as for material and manufacturing faults Barco must be informed immediately in writing of any complaints.

The period of guarantee begins on the date of transfer of risks, in the case of special systems and software on the date of commissioning, at latest 30 days after the transfer of risks. In the event of justified notice of complaint, Barco can repair the fault or provide a replacement at its own discretion within an appropriate period. If this measure proves to be impossible or unsuccessful, the purchaser can demand a reduction in the purchase price or cancellation of the contract. All other claims, in particular those relating to compensation for direct or indirect damage, and also damage attributed to the operation of software as well as to other services provided by Barco, being a component of the system or independent service, will be deemed invalid provided the damage is not proven to be attributed to the absence of properties guaranteed in writing or due to the intent or gross negligence or part of Barco.

If the purchaser or a third party carries out modifications or repairs on goods delivered by Barco, or if the goods are handled incorrectly, in particular if the systems are commissioned operated incorrectly or if, after the transfer of risks, the goods are subject to influences not agreed upon in the contract, all guarantee claims of the purchaser will be rendered invalid. Not included in the guarantee coverage are system failures which are attributed to programs or special electronic circuitry provided by the purchaser, e.g. interfaces. Normal wear as well as normal maintenance are not subject to the guarantee provided by Barco either.

The environmental conditions as well as the servicing and maintenance regulations specified in the this manual must be complied with by the customer.

## Software License Agreement

You should carefully read the following terms and conditions before using this software. Your use of this software indicates your acceptance of this license agreement and warranty.

### Terms and Conditions:

1. No redistribution of the software is allowed.
2. Reverse-Engineering. You may not reverse engineer, decompile, disassemble or alter anyhow this software product.

### Disclaimer of Warranty:

This software and the accompanying files are sold "as is" and without warranties as to performance or merchantability or any other warranties whether expressed or implied. In no event shall Barco be liable for damage of any kind, loss of data, loss of profits, business interruption or other pecuniary loss arising directly or indirectly. Any liability of the seller will be exclusively limited to replacement of the product or refund of purchase price.

### **GNU-GPL code**

If you would like a copy of the GPL source code contained in this product shipped to you on CD, please contact Barco. The cost of preparing and mailing a CD will be charged.

### **Disposal Information**

This equipment has required the extraction and use of natural resources for its production. It may contain hazardous substances for health and environment. In order to avoid the dissemination of those substances in the environment and to diminish the pressure on natural resources, we encourage you to use the appropriate take-back systems. Those systems will reuse or recycle most of the materials of your end of life equipment in a sound way.



The crossed-out wheeled bin symbol invites you to use those systems. If you need more information on the collection, reuse and recycling systems, please contact your local or regional waste administrator. You can also contact us for more information on the environmental performances of our products.

# TABLE OF CONTENTS

<b>1. Safety</b>	<b>5</b>
1.1 General	5
1.2 Important safety instructions	6
1.3 Recycling guidelines	8
1.4 Important warnings concerning CLM flight cases	9
<b>2. General</b>	<b>11</b>
2.1 Installation requirements	11
2.2 Unpacking the projector	12
2.3 Box content	13
2.4 Projector configurations	14
2.5 Projector air inlets and outlets	17
2.6 Free download of Projector Toolset	17
<b>3. Physical installation</b>	<b>19</b>
3.1 Remote control unit (RCU)	19
3.1.1 RCU battery installation	20
3.1.2 RCU rugged case installation	21
3.1.3 RCU XLR adaptor installation	21
3.1.4 Using the XLR adaptor of the RCU	22
3.1.5 RCU usage possibilities	22
3.2 Lenses	23
3.2.1 Available lenses	23
3.2.2 Lens selection	23
3.2.3 Lens formulas	24
3.3 Alignment of a table mounted CLM projector	24
3.4 Suspension of the CLM projector with rigging clamps	25
3.5 Alignment of a ceiling mounted CLM projector	29
<b>4. Stacking CLM projectors</b>	<b>31</b>
4.1 Stacking CLM projectors	31
4.2 Aligning stacked CLM projectors	33
<b>5. Connections</b>	<b>35</b>
5.1 Power connection	35
5.2 Input source connections	37
5.3 Communication connections	39
<b>6. Getting started</b>	<b>43</b>
6.1 RCU & Local keypad	43
6.2 Terminology overview	43
6.3 Operating the projector	45
6.3.1 Switching on	45
6.3.2 Errors, warnings and messages during start up	46
6.3.3 Switching to standby	46
6.3.4 Switching off	47
6.4 Using the RCU	47
6.5 Quick setup adjustments	48
6.5.1 Text boxes ON or OFF	48
6.5.2 Quick Lens Adjustment	48
6.5.2.1 Quick Lens Adjustment via LENS key	48
6.5.2.2 Direct Lens Adjustment (RCU)	49
6.5.3 Quick picture in picture	50
6.5.4 Quick layout selection with Rigging key	50
6.5.5 Quick language selection	51
6.6 Use of the AUTO button	51
6.7 Projector Address	51
6.7.1 Displaying and Programming addresses	51
6.7.2 Controlling the projector	52
6.8 Source selection	53
6.9 Controlling the Projector	53
<b>7. Start up of the adjustment mode</b>	<b>55</b>
7.1 About the adjustment mode	55
7.2 About the use of the remote control and the local keypad	55
7.3 Start up the adjustment mode	55
7.4 Navigation and adjustments	56
7.5 On screen menus versus LCD display menus	56
<b>8. Input menu</b>	<b>59</b>
8.1 Overview flow	59
8.2 Slot module type	59
8.2.1 About Input Setup	59

8.2.2	Input configuration .....	60
8.3	Input locking .....	61
8.4	Minimum delay.....	63
8.5	Native resolution.....	63
8.6	Source switching .....	65
8.7	No signal.....	65
8.7.1	Background color .....	66
8.7.2	Shutdown setting.....	66
8.7.3	Shutdown retarding time.....	66
<b>9.</b>	<b>Image menu .....</b>	<b>69</b>
9.1	Overview flow.....	69
9.2	How to select the image adjustments? .....	70
9.3	Image Settings.....	70
9.3.1	Contrast .....	71
9.3.2	Brightness .....	71
9.3.3	Saturation .....	72
9.3.4	Tint (hue).....	73
9.3.5	Phase.....	73
9.3.6	Sharpness.....	74
9.3.7	Noise reduction .....	75
9.3.8	Color temperature.....	76
9.3.8.1	Predefined color temperature .....	76
9.3.8.2	Set a custom color temperature .....	77
9.3.9	Input balance.....	78
9.3.9.1	Introduction to Input Balance .....	78
9.3.9.2	Adjusting the input balance .....	79
9.4	Aspect ratio .....	82
9.5	Timings.....	83
9.5.1	Source timings .....	83
9.5.2	Advanced settings .....	84
9.5.3	Advanced settings, film mode detection .....	86
9.5.4	Advanced setting, brilliant color look .....	87
9.6	Image files services .....	88
9.6.1	Files and file manipulations.....	88
9.6.2	Manual Load file .....	89
9.6.3	Delete file.....	89
9.6.4	Delete all custom files .....	90
9.6.5	Rename a file .....	91
9.6.6	Copy a file .....	92
9.6.7	File options .....	92
9.7	Save custom settings.....	93
<b>10.</b>	<b>Layout menu .....</b>	<b>95</b>
10.1	Overview flow.....	95
10.2	Main window.....	95
10.2.1	Source selection .....	96
10.2.2	Size adjustment.....	96
10.2.3	Position adjustment .....	99
10.3	PIP window .....	100
10.3.1	Introduction to PIP .....	100
10.3.2	Picture in Picture activation.....	101
10.3.3	Picture in Picture source selection .....	101
10.3.4	Picture in Picture size of the window .....	102
10.3.5	Picture in Picture, position window .....	105
10.4	Layout file services .....	106
10.4.1	Load layout.....	106
10.4.2	Rename a layout.....	107
10.4.3	Delete a layout .....	107
10.4.4	Copy / Save as a layout .....	108
<b>11.</b>	<b>Lamp menu .....</b>	<b>111</b>
11.1	Overview flow.....	111
11.2	Lamp power mode.....	111
11.3	Lamp power.....	112
11.4	Lamp Identification .....	113
11.5	Status and run time overview lamps.....	114
11.6	Lamp mode .....	114
<b>12.</b>	<b>Alignment menu .....</b>	<b>115</b>
12.1	Overview flow.....	115
12.2	Orientation .....	116
12.3	Lens adjustment .....	117
12.4	Side keystone.....	118
12.5	Blanking.....	119
12.6	Intensity .....	120
12.7	Gamma .....	120

12.8	Internal pattern.....	121
12.9	Color space .....	122
12.10	White peaking .....	123
12.11	ScenergiX.....	124
12.11.1	Introduction.....	124
12.11.2	Preparations.....	125
12.11.3	ScenergiX activation .....	125
12.11.4	ScenergiX pattern .....	125
12.11.5	ScenergiX overlap zone (horizontal ScenergiX) .....	126
12.11.6	ScenergiX overlap zone (vertical ScenergiX) .....	128
12.11.7	ScenergiX size adjustment (White level).....	129
12.11.8	Adjusting the black level of the images .....	131
<b>13.</b>	<b>Projector control .....</b>	<b>135</b>
13.1	Overview flow .....	135
13.2	Projector address .....	136
13.2.1	Individual projector address .....	136
13.2.2	Common address .....	137
13.3	Serial communication.....	137
13.3.1	Baud rate setup .....	138
13.3.2	Interface standard .....	138
13.3.3	RS422 termination .....	139
13.4	Network .....	139
13.4.1	Introduction to a Network connection .....	140
13.4.2	DHCP setup .....	140
13.4.3	IP-address set up .....	141
13.4.4	Subnet-mask set up .....	141
13.4.5	Default Gateway set up .....	142
13.5	IR control switching.....	143
13.6	DMX.....	144
13.6.1	DMX address.....	144
13.6.2	DMX universe .....	145
13.6.3	DMX monitor .....	145
13.6.4	DMX mode .....	147
13.6.5	Art-Net Activation .....	147
13.7	Buttons.....	148
13.7.1	APA button .....	148
13.7.2	Shortcut keys.....	148
13.8	Menu position.....	149
13.9	Local LCD contrast .....	150
13.10	Language selection.....	150
<b>14.</b>	<b>Service menu.....</b>	<b>153</b>
14.1	Overview flow .....	153
14.2	Identification .....	153
14.3	Diagnosis .....	155
14.3.1	How to start up the diagnosis? .....	155
14.3.2	Versions .....	155
14.3.3	Voltages .....	156
14.3.4	I <sup>2</sup> C diagnosis .....	157
14.3.5	Temperatures .....	157
14.3.6	Fan speeds overview .....	158
14.3.7	SPI.....	159
14.3.8	Error logging overview .....	159
14.4	Internal service patterns .....	160
14.5	Restore factory defaults .....	160
14.6	Save custom settings.....	161
14.7	Refill mode.....	162
14.8	USB memory .....	163
14.9	Over temperature DMD safety .....	164
<b>15.</b>	<b>Maintenance.....</b>	<b>167</b>
15.1	Cleaning the lens .....	167
15.2	Cleaning the exterior of the projector .....	167
15.3	Level check of cooling liquid .....	167
<b>16.</b>	<b>Servicing.....</b>	<b>169</b>
16.1	Replacement of the dust filter on the top side .....	169
16.2	Replacement of the dust filters on the front side .....	170
16.3	Lens installation .....	171
16.4	Lens removal .....	172
16.5	Removal of a lamp unit.....	173
16.6	Mounting a new lamp unit .....	175
16.7	Removal of an input module .....	176
16.8	Inserting an input module .....	177
16.9	Top-up the reservoir with cooling liquid .....	177

<b>17. Projector covers, removal and installation .....</b>	<b>181</b>
17.1 Removal of the front cover .....	181
17.2 Removal of the lamp door .....	182
17.3 Removal of the back cover .....	183
17.4 Removal of the top cover .....	184
17.5 Removal of the side cover .....	184
17.6 Installation of the side cover .....	185
17.7 Installation of the top cover .....	186
17.8 Installation of the back cover .....	186
17.9 Installation of the front cover .....	187
17.10 Installation of the lamp door .....	188
<b>A. Dimensions .....</b>	<b>191</b>
A.1 Dimensions of the CLM HD8 .....	191
<b>B. Standard Source Files .....</b>	<b>193</b>
B.1 Table overview .....	193
<b>C. DMX Chart .....</b>	<b>195</b>
C.1 CLM control channel mapping (Full mode) .....	195
C.2 CLM control channel mapping (Basic mode) .....	196
<b>D. Specifications .....</b>	<b>199</b>
D.1 Specifications CLM HD8 .....	199
D.2 Specifications CLM 5 cable input (multi purpose) .....	201
D.3 Specifications CLM HDSDI – SDI input .....	202
D.4 Specifications CLM DVI input .....	203
D.5 Specifications CLM DVI HDCP input .....	203
<b>E. Troubleshooting .....</b>	<b>205</b>
E.1 Error codes .....	205
<b>F. Mounting optional Carry handle .....</b>	<b>211</b>
F.1 Mounting stacking points on top cover .....	211
F.2 Preparing the new carry handle .....	212
F.3 Preparing the projector .....	213
F.4 Mounting the carry handle .....	214
<b>G. Order info .....</b>	<b>217</b>
G.1 Spare part order info .....	217
<b>Glossary .....</b>	<b>219</b>
<b>Index .....</b>	<b>221</b>



# 1. SAFETY

## About this chapter

Read this chapter attentively. It contains important information to prevent personal injury while installing and using an CLM HD8 projector. Furthermore, it includes several cautions to prevent damage to the CLM HD8. Ensure that you understand and follow all safety guidelines, safety instructions and warnings mentioned in this chapter before installing your CLM projector. After this chapter, additional "warnings" and "cautions" are given depending on the installation procedure. Read and follow these "warnings" and "cautions" as well.

## Overview

- General
- Important safety instructions
- Recycling guidelines
- Important warnings concerning CLM flight cases

## 1.1 General

### Notice on safety

This equipment is built in accordance with the requirements of the international safety standards IEC60950-1, EN60950-1, UL60950-1 and CAN/CSA C22.2 No.60950-1, which are the safety standards of information technology equipment including electrical business equipment. These safety standards impose important requirements on the use of safety critical components, materials and insulation, in order to protect the user or operator against risk of electric shock and energy hazard, and having access to live parts. Safety standards also impose limits to the internal and external temperature rises, radiation levels, mechanical stability and strength, enclosure construction and protection against the risk of fire. Simulated single fault condition testing ensures the safety of the equipment to the user even when the equipment's normal operation fails.

### Installation instructions

- Before operating this equipment please read this manual thoroughly, and retain it for future reference.
- Installation and preliminary adjustments should be performed by qualified Barco personnel or by authorized Barco service dealers.
- All warnings on the projector and in the documentation manuals should be adhered to.
- All instructions for operating and use of this equipment must be followed precisely.



**Definition of "qualified service technicians" or "qualified technicians":** Persons having appropriate technical training and experience necessary to be aware of hazards to which they are exposed in performing a task and of measures to minimize the danger to themselves or other persons.

### Owners record

The part number and serial number are located at the right side of the projector. Record these numbers in the spaces provided below. Refer to them whenever you call upon your Barco dealer regarding this product.

Product article number	
Product serial number	
Dealer	

## 1.2 Important safety instructions

---

### To prevent the risk of electrical shock

- **Warning:** This apparatus must be grounded (earthed) via the supplied 3 conductor AC power cable. If none of the supplied power cables are the correct one, consult your dealer.  
If you are unable to insert the plug into the outlet, contact your electrician to replace your obsolete outlet. Do not defeat the purpose of the grounding-type plug.

The wires of the power cord are colored in accordance with the following code:

**International plug:**

Green/Yellow: ground.

Blue: neutral.

Brown: line (live)

**North American plug:**

Green/Yellow or Green: ground.

Blue or White: neutral.

Brown or Black: line (live)

- Do not allow anything to rest on the power cord. Do not locate this product where persons will walk on the cord. To disconnect the cord, pull it out by the plug. Never pull the cord itself.
- If an extension cord is used with this product, make sure that the total of the ampere ratings on the products plugged into the extension cord does not exceed the extension cord ampere rating.
- Use only the power cord supplied with your projector. While appearing to be similar, other power cords have not been safety tested at the factory and may not be used to power the projector. For a replacement power cord, contact your dealer.
- Never push objects of any kind into this product through cabinet slots as they may touch dangerous voltage points or short out parts that could result in a risk of fire or electrical shock.
- Never spill liquid of any kind on the product. Should any liquid or solid object fall into the cabinet, unplug the set and have it checked by qualified service personnel before resuming operations.
- Lightning - For added protection for this video product during a lightning storm, or when it is left unattended and unused for long periods of time, unplug it from the wall outlet. This will prevent damage to the projector due to lightning and AC power-line surges.

### To prevent personal injury

- **Caution:** High pressure lamp may explode if improperly handled. Refer servicing to qualified service personnel. The customer should never attempt to disassemble the lamp casing or to dispose of the lamp casing other than by returning it to Barco.
- To prevent injury and physical damage, always read this manual and all labels on the system before inserting the lamp casing, connecting to the wall outlet or adjusting the projector.
- To prevent injury, take note of the weight of the projector. Minimum 2 persons are needed to carry the projector.
- To prevent injury, ensure that the lens and all cover plates are correctly installed. See installation procedures.
- **Warning:** high intensity light beam. NEVER look into the lens ! High luminance could result in damage to the eye.
- Before attempting to remove any of the projector's covers, you must turn off the projector and disconnect from the wall outlet.
- When performing setup work to a ceiling mounted projector, to prevent injury caused by falling objects or the system, set out a keep out area.
- Consult a professional structural engineer prior to suspending the projector from a structure not intended for that use. Always ensure that the working load limit of the structure can handle the load of the projector.
- Never stack more than two (2) CLM projectors in a hanging configuration (truss) and never stack more than three (3) CLM projectors in a base stand configuration (table mount).
- The power input at the projector side is considered as the disconnect device. When required to switch off the projector, to access parts inside, always disconnect the power cord at the projector side. In case the power input at the projector side is not accessible (e.g. ceiling mount), the socket outlet supplying the projector shall be installed nearby the projector and be easily accessible, or a readily accessible general disconnect device shall be incorporated in the fixed wiring.
- Do not place this equipment on an unstable cart, stand, or table. The product may fall, causing serious damage to it and possible injury to the user.
- When mounting the projector to the ceiling or to a rigging system, always mount security chains.
- **Warning: Protection from ultraviolet radiation:** Do not look directly in the light beam. The lamp contained in this product is an intense source of light and heat. One component of the light emitted from this lamp is ultraviolet light. Potential eye and skin hazards are present when the lamp is energized due to ultraviolet radiation. Avoid unnecessary exposure. Protect yourself and your employees by making them aware of the hazards and how to protect themselves. Protecting the skin can be accomplished by wearing tightly woven garments and gloves. Protecting the eyes from UV can be accomplished by wearing safety glasses that are designed to provide UV protection. In addition to the UV, the visible light from the lamp is intense and should also be considered when choosing protective eye wear.
- **Exposure to UV radiation:** Some medications are known to make individuals extra sensitive to UV radiation. The American Conference of Governmental Industrial Hygienists (ACGIH) recommends occupational UV exposure for an 8-hour day to be less than 0.1 microwatts per square centimeters of effective UV radiation. An evaluation of the workplace is advised to assure employees are not exposed to cumulative radiation levels exceeding these government guidelines.

- **Mercury Vapor Warnings:** Keep the following warnings in mind when using the projector. The lamp used in the projector contains mercury. In case of a lamp rupture, explosion there will be a mercury vapor emission. In order to minimize the potential risk of inhaling mercury vapors:
  - Ensure the projector is installed only in ventilated rooms.
  - Replace the lamp module before the end of its operational life.
  - Promptly ventilate the room after a lamp rupture, explosion has occurred, evacuate the room (particularly in case of a pregnant woman).
  - Seek medical attention if unusual health conditions occur after a lamp rupture, explosion, such as headache, fatigue, shortness of breath, chest-tightening coughing or nausea.
- **Cooling liquid circuit.** The projector contains a cooling circuit filled with Blue antifreeze diluted 1,2 ethanediol (1/3 ethanediol – 2/3 Demi water).  
When the cooling circuit leaks, switch off the projector and contact a service technician.  
The liquid is not for household use. Keep out of reach of children. Harmful by oral intake. Avoid exposure to pregnant women. Avoid contact with eyes, skin and clothing. Avoid inhale of the noxious fumes.
- Never use the projector with its backside downwards. Forbidden area is +70° and -70° compared with the vertical axis.

### To prevent projector damage

- If the Air Filters are not regularly replaced, the air flow inside the projector could be disrupted, causing overheating. Overheating may lead to the projector shutting down during operation.
- In order to ensure that correct airflow is maintained, and that the projector complies with electromagnetic compatibility (EMC) requirements, and for safety requirements, it should always be operated with all of its covers in place.
- Slots and openings in the cabinet are provided for ventilation. To ensure reliable operation of the product and to protect it from overheating, these openings must not be blocked or covered. The openings should never be blocked by placing the product on a bed, sofa, rug, or other similar surface. This product should never be placed near or over a radiator or heat register. The projector should not be placed in a built-in installation or enclosure unless proper ventilation is provided.
- Do not block the projector cooling fans or free air movement under and around the projector. Loose papers or other objects may not be nearer to the projector than 40 cm (16") on any side.
- The projector must always be mounted in a manner which ensures free flow of air into its air inlets and unimpeded evacuation of the hot air exhausted from its cooling system. Heat sensitive materials should not be placed in the path of the exhausted air. Leave at least a free safety area of 1 meter (40") at the rear of the projector.
- Ensure that nothing can be spilled on, or dropped inside the projector. If this does happen, switch off and unplug the mains supply immediately. Do not operate the projector again until it has been checked by qualified service technicians.
- Consult a professional structural engineer prior to suspending the ceiling mount from a structure not intended for that use. Always ensure the working load limit of the structure supporting the projector.
- Do not use this equipment near water.
- Special care should be used when DLP projectors are used in the same room as high power laser equipment. Direct or indirect hitting of a laser beam on to the lens can severely damage the Digital Mirror Devices™ in which case there is a loss of warranty.
- Save the original shipping carton and packing material; they will come in handy if you ever have to ship your equipment. For maximum protection, repack your set as it was originally packed at the factory.
- Unplug this product from the wall outlet before cleaning. Do not use liquid cleaners or aerosol cleaners. Use a damp cloth for cleaning. Never use strong solvents, such as thinner or benzine, or abrasive cleaners, since these will damage the cabinet. Stubborn stains may be removed with a cloth lightly dampened with mild detergent solution.
- To ensure the highest optical performance and resolution, the projection lenses are specially treated with an anti-reflective coating, therefore, avoid touching the lens. To remove dust on the lens, use a soft dry cloth. Do not use a damp cloth, detergent solution, or thinner.
- Never use the projector with its backside downwards. Forbidden area is +70° and -70° compared with the vertical axis.
- Never use the projector when not all four lamps are installed.

### To prevent battery explosion

- Danger of explosion if battery is incorrectly installed.
- Replace only with the same or equivalent type recommended by the manufacturer.
- Dispose of used batteries according to the manufacturer's instruction.

### To prevent fire hazard

- Warning "Risk of fire". Do not place flammable or combustible materials near the projector !  
This projector radiates heat on its external surfaces and from ventilation ducts during normal operation, which is both normal and safe. Exposing flammable or combustible materials into close proximity of this projector could result in the spontaneous ignition of that material, resulting in a fire. For this reason, it is absolutely necessary to leave an "exclusion zone" around all external surfaces of the projector whereby no flammable or combustible materials are present. The exclusion zone must be not less than 40 cm (16") for all Barco DLP projectors. The exclusion zone on the lens side must be at least 2 meter (80").
- Do not cover the projector or the lens with any material while the projector is in operation.
- To reduce the lamp heat of the projector, switch the projector first to standby and let the projector lamp cool down for at least 5 minutes. Then the projector may be switched off with the power switch.
- Mount the projector in a well ventilated area away from sources of ignition and out of direct sun light.
- Never expose the projector to rain or moisture.

## 1. Safety

---

- In the event of fire, use sand, CO<sub>2</sub>, or dry powder fire extinguishers; never use water on an electrical fire.
- This product should never be placed near or over a radiator or heat register.
- This projector should not be placed in a built-in installation or enclosure unless proper ventilation is provided.
- Projection rooms must be well ventilated or cooled in order to avoid build up of heat.

### On servicing

- Do not attempt to service this product yourself, as opening or removing covers may expose you to dangerous voltage potentials and risk of electric shock.
- Refer all servicing to qualified service personnel.
- Fence off a restricted area of at least 3 meters around the projector using an eye-catching fence and "KEEP OUT" signs. This to prevent unauthorized persons coming near the projector during servicing.
- Unplug this product from the wall outlet and refer servicing to qualified service technicians under the following conditions:
  - When the power cord or plug is damaged or frayed.
  - If liquid has been spilled into the equipment.
  - If the product has been exposed to rain or water.
  - If the product does not operate normally when the operating instructions are followed. Adjust only those controls that are covered by the operating instructions since improper adjustment of the other controls may result in damage and will often require extensive work by a qualified technician to restore the product to normal operation.
  - If the product has been dropped or the cabinet has been damaged.
  - If the product exhibits a distinct change in performance, indicating a need for service.
- Replacement parts: When replacement parts are required, be sure the service technician has used original Barco replacement parts or authorized replacement parts which have the same characteristics as the Barco original part. Unauthorized substitutions may result in degraded performance and reliability, fire, electric shock or other hazards. Unauthorized substitutions may void warranty.
- Safety check: Upon completion of any service or repairs to this projector, ask the service technician to perform safety checks to determine that the product is in proper operating condition.

## 1.3 Recycling guidelines

---



**WARNING: Do not break or crush lamps because this may pose health and environmental risks when mercury vapors are released.**

---



**CAUTION: To avoid breaking the lamps, repack carefully when storing and transporting them.**

---



**CAUTION: Lamps may not be disposed as normal household trash.**

**Contact your local waste disposal facility for information on the recycling program for HID (High Intensity Discharge ) lamps in your area.**

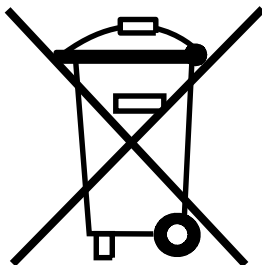

Image 1-1

---

### Disposal options for mercury-containing lamps

- Recycle through a municipal or solid waste district household hazardous waste collection program in accordance with local regulations.
- Direct shipment to lamp recycler
- Shipment through a hazardous waste transporter

## 1.4 Important warnings concerning CLM flight cases

---

### Important warnings concerning stacking/transporting CLM rental flight cases

- Stack maximum two (2) CLM rental flight cases high. Never higher.
- Surface on which flight case is standing must be level to ensure that the total load is evenly spread out among the four wheels. The surface must also be able to support the load safely.
- Before stacking or transporting flight cases, check the wheels and their fixation screws for wear or defects.
- Before stacking or transporting flight cases, check that the four lock handles on each flight case are in good working order and locked securely.
- When stacked, make sure the wheels of the upper flight case are precisely positioned in the stacking dishes of the flight case below.
- Stacked flight cases may not be moved. Before stacking, the lower flight case must already be in its final resting position before placing the second upon it.
- Never stack loaded flight cases in a truck or other transport medium, unless each flight case is rigidly strapped tight.
- In the event of a wheel breaking, flight cases must be rigidly strapped tight to prevent a stack collapsing.
- Use an appropriate forklift to raise flight cases and take the necessary precautions to avoid personnel injury.



## 2. GENERAL

### About this chapter

Read this chapter before installing your CLM HD8. It contains important information concerning installation requirements for the CLM HD8, such as minimum and maximum allowed ambient temperature, humidity conditions, required safety area around the installed projector, required power net, compatible signal sources, etc.

Furthermore, careful consideration of things such as image size, ambient light level, projector placement and type of screen to use are critical to the optimum use of the projection system.

### Overview

- Installation requirements
- Unpacking the projector
- Box content
- Projector configurations
- Projector air inlets and outlets
- Free download of Projector Toolset

## 2.1 Installation requirements

### Ambient temperature conditions

The maximum allowed ambient temperature for an operating Barco CLM HD8 may not exceed +40 °C (+104 °F).

The minimum allowed ambient temperature for an operating Barco CLM HD8 may not drop below +10 °C (+50 °F).

The projector will not operate if the ambient air temperature falls outside this range (+10 °C → +40 °C or +50 °F → +104 °F). Be aware that room heat rises to the ceiling. Check if the temperature near the installation site is not excessive.

The minimum storage temperature is -35 °C (-31 °F) and the maximum storage temperature is +65 °C (+149 °F).

### Humidity conditions

Storage: 0 to 98% relative humidity, non-condensing.

Operation: 0 to 95% relative humidity, non-condensing.

### High Altitude

For an optimal performance of the CLM at high altitude, make sure that sufficient air flow is available (maximum ambient temperature 30°C).

### Projector weight

Do not underestimate the weight of one Barco CLM HD8, which is about ±31 kg (±68 lb.). Be sure that the table or truss installation on which the projector(s) has to be installed is capable of handling five (5) times the complete load of the complete system.

### Power requirements

One Barco CLM HD8 (order number R9050130 and R90501301) requires 100-120/200-240V 12/8A 50/60Hz.

One Barco CLM HD8 (order number R90501305) requires 100-120/200-240V 16/8A 50/60Hz.

### Clean air environment

A projector must always be mounted in a manner which ensures the free flow of clean air into the projectors ventilation inlets. For installations in environments where the projector is subject to airborne contaminants such as that produced by smoke machines or similar (these deposit a thin layer of greasy residue upon the projectors internal optics and imaging electronic surfaces, degrading performance), then it is highly advisable and desirable to have this contamination removed prior to it reaching the projectors clean air supply. Devices or structures to extract or shield contaminated air well away from the projector are a prerequisite, if this is not a feasible solution then measures to relocate the projector to a clean air environment should be considered.

Only ever use the manufacturer's recommended cleaning kit which has been specifically designed for cleaning optical parts, never use industrial strength cleaners on the projector's optics as these will degrade optical coatings and damage sensitive optoelectronics components. Failure to take suitable precautions to protect the projector from the effects of persistent and prolonged air contaminants will culminate in extensive and irreversible ingrained optical damage. At this stage cleaning of the internal optical units will be non-effective and impracticable. Damage of this nature is under no circumstances covered under the manufacturer's warranty and may deem the warranty null and void. In such a case the client shall be held solely responsible for all costs incurred during any repair. It is the clients responsibility to ensure at all times that the projector is protected from the harmful effects of hostile airborne particles in the environment of the projector. The manufacturer reserves the right to refuse repair if a projector has been subject to knowingly neglect, abandon or improper use.

### Which screen type ?

There are two major categories of screens used for projection equipment. Those used for front projected images and those for rear projection applications.

Screens are rated by how much light they reflect (or transmit in the case of rear projection systems) given a determined amount of light projected toward them. The 'GAIN' of a screen is the term used. Front and rear screens are both rated in terms of gain. The gain of screens range from a white matte screen with a gain of 1 (x 1) to a brushed aluminized screen with a gain of 10 (x 10) or more. The choice between higher and lower gain screens is largely a matter of personal preference and another consideration called the viewing angle. In considering the type of screen to choose, determine where the viewers will be located and go for the highest gain screen possible. A high gain screen will provide a brighter picture but reduce the viewing angle. For more information about screens, contact your local screen supplier.

### What image size? How big should the image be?

The projector is designed for projecting an image size : minimum 2.2 meter (7.2 ft.) to maximum 10 .8 meter (35.4 ft.) (depending on the ambient light conditions), with an aspect ratio of 16 to 9 .

## 2.2 Unpacking the projector

---

### What has to be done ?

At delivery the projector is packed in a cardboard box upon a wooden pallet and secured with banding and fastening clips. Furthermore, to provide protection during transport, the projector is surrounded with foam. Once the projector has arrived at the installation site, it has to be removed from the cardboard box and wooden pallet in a safe manner without damaging the projector.

### Necessary tools

Side cutter

### How to unpack the projector

1. Remove the banding around the carton box, by releasing the fastening clips.
2. Cut open the box but do not insert the cutter too deep, otherwise the projector could be damaged.

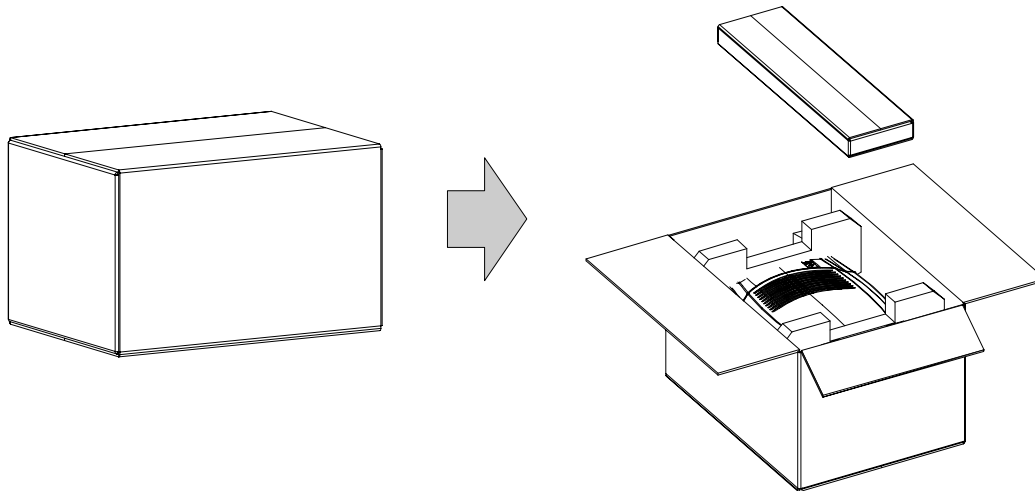

Image 2-1

3. Take out the cardboard box with the accessories such as manuals, remote control and power cord.
4. Take the projector out of the cardboard box and place it on a stable table.



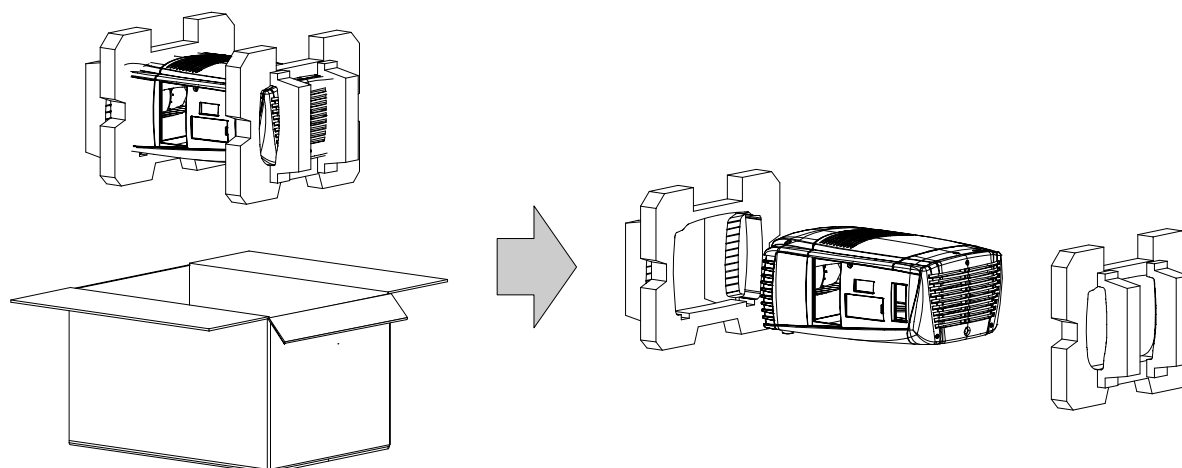

Image 2-2

5. Remove the foam rubber.



**Save the original shipping carton and packing material, they will be necessary if you ever have to ship your projector. For maximum protection, repack your projector as it was originally packed at the factory.**



**A rubber foam inside a plastic bag is placed into the lens opening of the projector. It's recommended to reuse this foam and plastic back each time you transport the projector. This to prevent intrusion of dust and foreign particles.**



**CAUTION: Always remove the lens before transporting the projector !**

## 2.3 Box content

### Content

- One Barco CLM HD8, weight  $\pm 31$  kg ( $\pm 68$  lb.).
- One Remote Control Unit (RCU).
- Two AA size batteries for the RCU.
- Two power cord of 2.5 meter, one CEEC19 and one NEM6C19.
- One user manual.
- One safety manual.

### Initial inspection

Before shipment, the projector was inspected and found to be free of mechanical and electrical defects. As soon as the projector is unpacked, inspect for any damage that may have occurred in transit. Save all packing material until the inspection is completed. If damaged is found, file claim with carrier immediately. The Barco sales and service office should be notified as soon as possible.



**The packaging of the CLM HD8 is provided with a shock-watch label. If this shock-watch label was triggered (red colored at arrival) during transport, that indicates the package was possibly roughly handled by the transport company. In this case, the instructions mentioned on the label, should be followed, which are: adding a note on the transportation document and informing the transport company and the Barco sales and service office as soon as possible.**

### Mechanical check

This check should confirm that there are no broken knobs or connectors, that the cabinet and panel surfaces are free of dents and scratches, and that the operating panel are not scratched or cracked. The Barco sales and service office should be notified as soon as possible.

## 2.4 Projector configurations

### The different configurations

Depending on the installation the projector can be mounted in different ways, the 4 different configurations are:

1. Front / Table (F/T)
2. Front / Ceiling (F/C)
3. Rear / Table (R/T)
4. Rear / Ceiling (R/C)



For a ceiling mounted configuration, the optional carry handle kit is required.

### Front projection

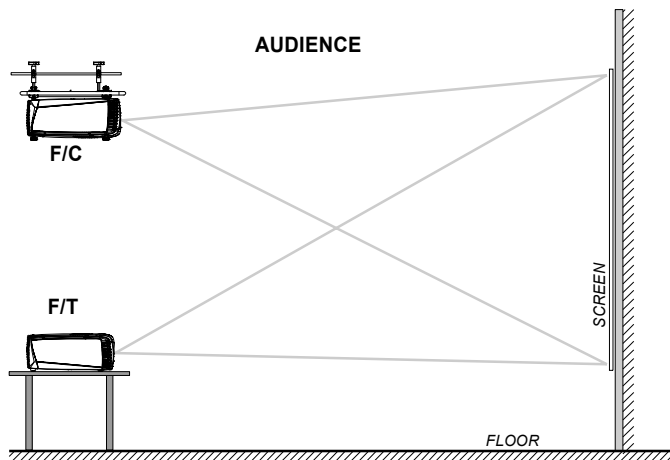

Image 2-3  
Front projection

### Rear projection

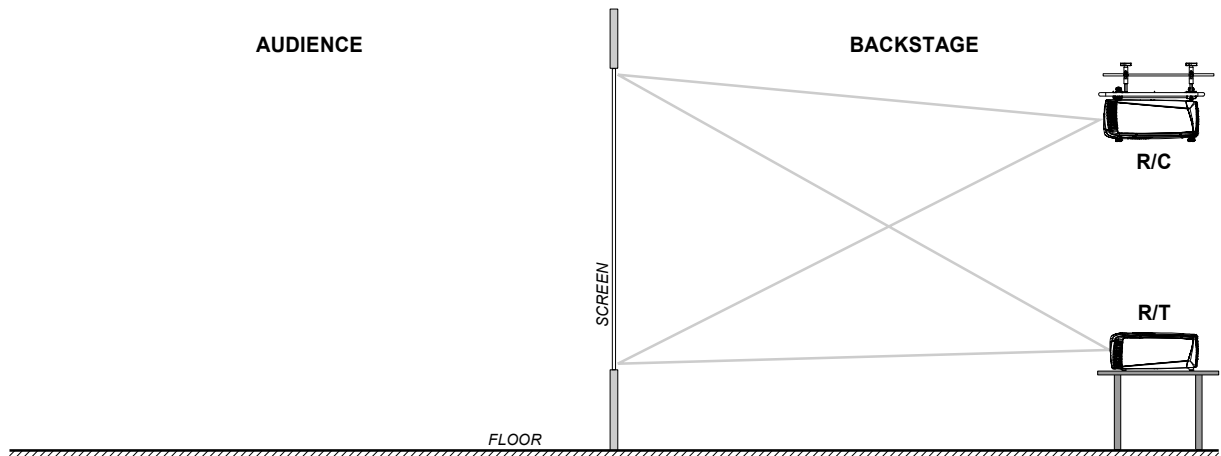

Image 2-4  
Rear projection

## Positioning the projector

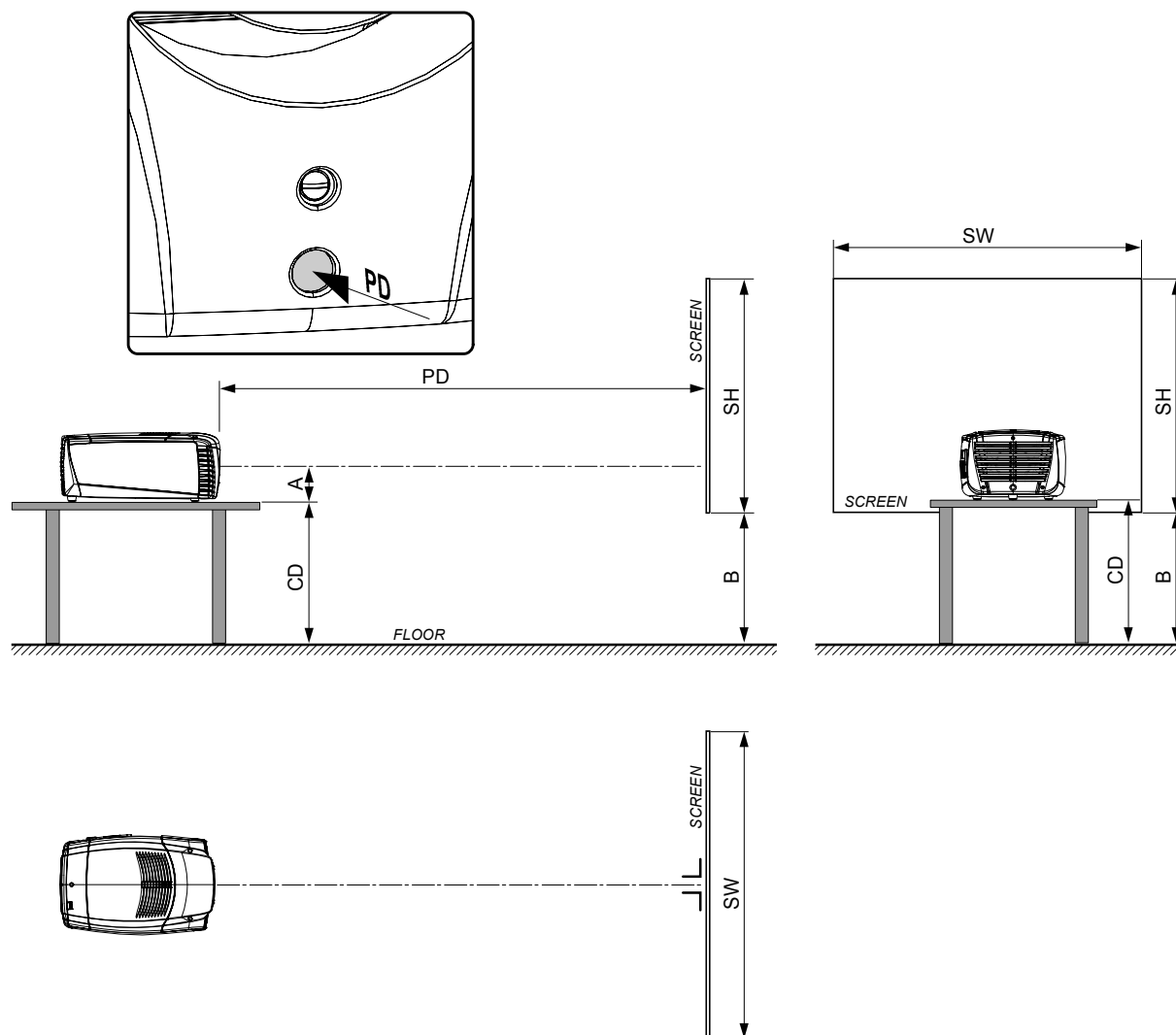

Image 2-5

## On-Axis / Off-Axis projection

The position of the projector with reference to the screen may also be different depending on the installation. Basically the projector can be positioned in On-Axis or Off-Axis configuration. On-Axis configuration means that the projector is positioned so as to have the centre of the lens coinciding with the centre of the screen. Off-Axis projection is obtained by shifting the lens up, down, left or right. Several parameters can be calculated determining the position in any installation.

Formula to calculate the distance  $CD$  for On-Axis projection:  $CD = SH/2 + B - A$

## Shift range

The lens can be shifted with respect to the DMD (P) which result in a shifted image on the screen (Off-Axis). A 100% shift means that the centre point of the projected image is shifted by half the screen size. In other words, the centre point of the projected image falls together with the outline of the image in an On-Axis projection. Due to mechanical and optical limitations it's recommended to keep the shift values within the field of view (F) as illustrated below. Within these shift ranges the projector and lens perform excellently. Configuring the projector outside these shift ranges will result in a slight decline of image quality.

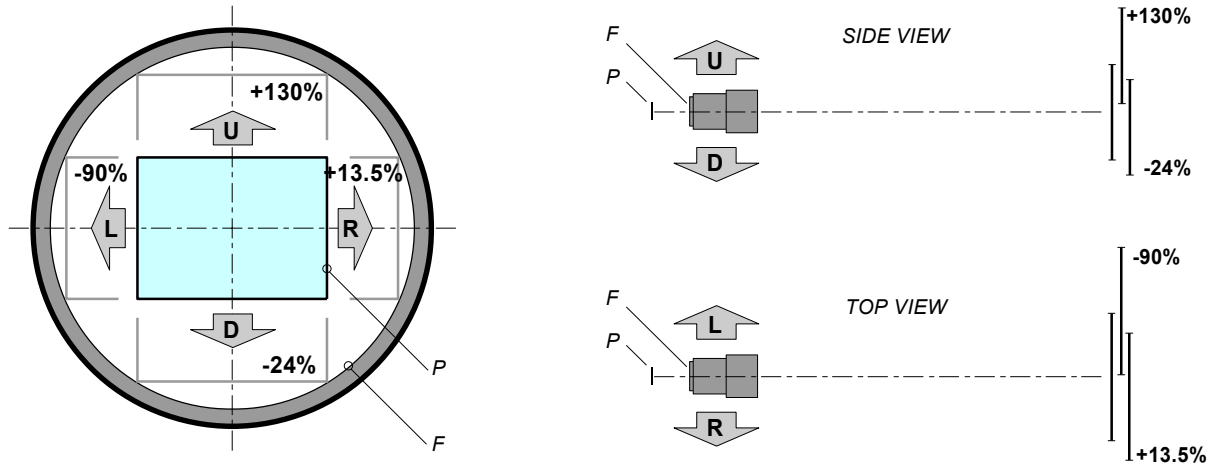

Image 2-6  
Shift range  
P DMD  
F Field of view



It's mechanical possible to shift outside the recommended field of view, but this will result in a slightly decline of image quality depending on the used lens and the zoom position of the used lens. Furthermore, shifting too much in both directions will result in a blurred image corner.

### Horizontal and vertical projector tilt ranges

The projector is designed to work in a table or ceiling mounted position, but tilting is allowed. Never tilt the backside of the projector inside the forbidden area A.

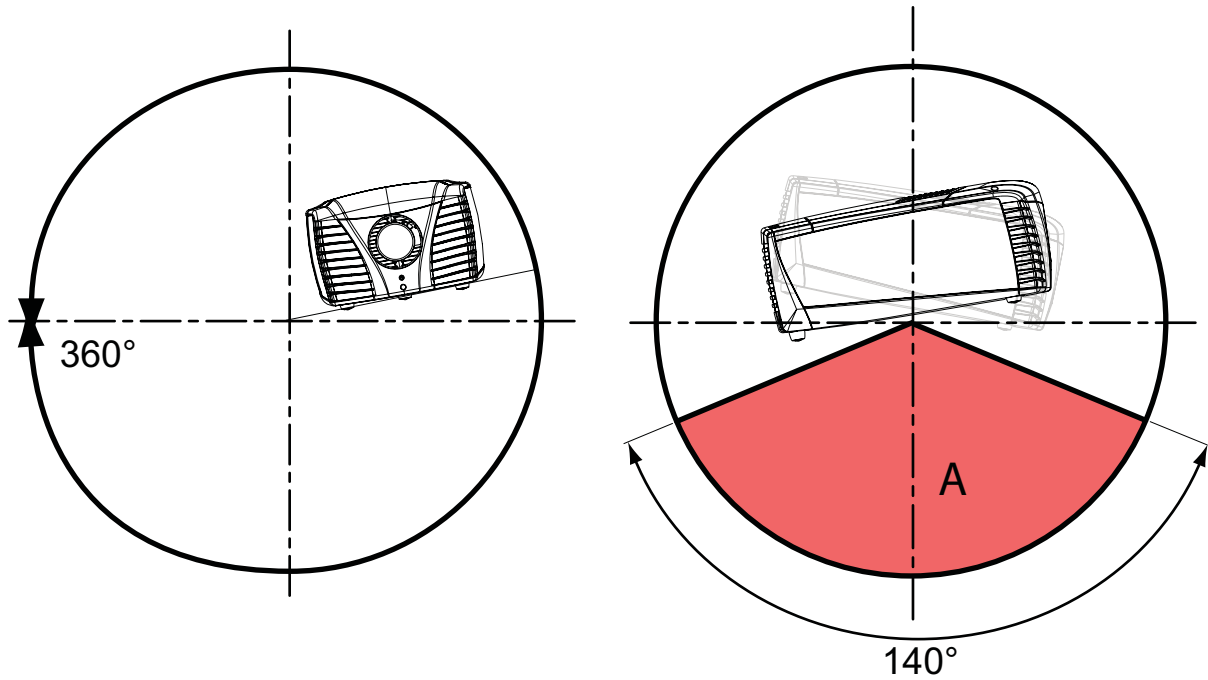

Image 2-7  
Tilt area

## 2.5 Projector air inlets and outlets

### Air inlets and outlets

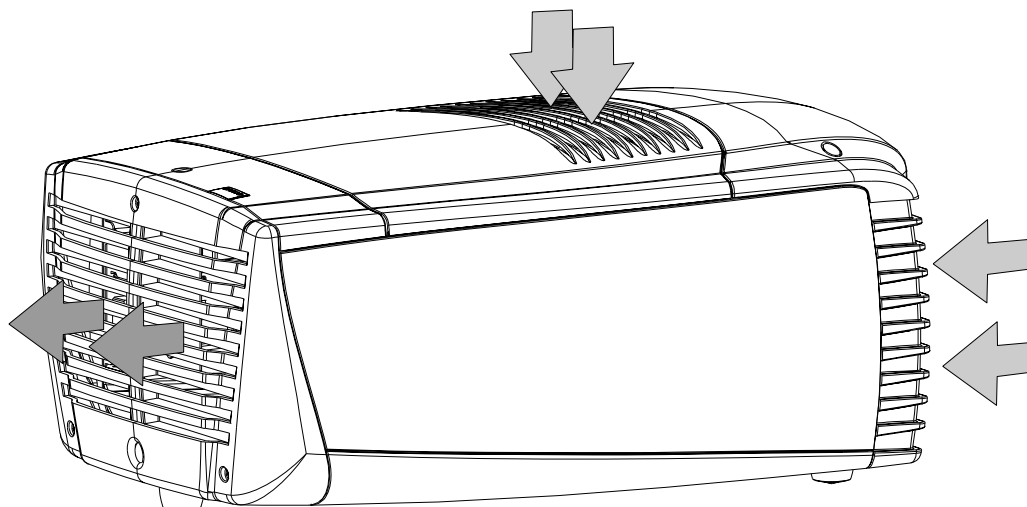

Image 2-8

The CLM HD8 has 2 inlet channels and one air outlet. The air outlet is located at the rear of the projector. The air inlets are located at the front and top of the projector.

## 2.6 Free download of Projector Toolset

### About Projector Toolset

Projector Toolset is a software tool to set up, configure, manage and control Barco projectors.

The concept of this Projector Toolset software is modular. The basic package can be extended with several optional device plug-in modules, now and in the future available.

The Projector Toolset software works with configurations that can be loaded. Within a configuration, different snapshots can be taken. A snapshot represents a current state of a configuration and can be reloaded to return to this typical state. These terms will be used through the complete software.

Projector Toolset is a stand-alone application that runs on a Java Virtual Machine and that does not require extra services to run.

Several configurations can be controlled simultaneously. Even when the configurations are connected via different ways.



**Projector Toolset is only available in a download version, no CD can be ordered.**

### Where to find the download file(s)

The program and all necessary plug-ins, as well as the Reference manual can be downloaded for free from Barco's Partnerzone, URL <https://my.barco.com>. Registration is necessary.

If you are not yet registered, click on Partnerzone registration and follow the instructions. With the created login and password, it is possible to enter the partnerzone where you can download the Projector Toolset software and the device plug-in updates as well as the corresponding reference manual.

When downloading the complete Projector Toolset, this software contains already the latest device plug-ins. When you already have the latest core version of Projector Toolset, it is possible to download only device plug-in updates from the same web site location.

As Projector Toolset is a stand alone application, it is not necessary to install any other software. A Java virtual machine is included with this download.

### Installation

Download first the reference manual (Part number: R59770052) and follow the installation instructions as written in this manual.



## 3. PHYSICAL INSTALLATION

### About this chapter

This chapter explains how to install and set up your CLM projector. If you are familiar with the projector and want to quickly set it up for temporary use, follow the "Quick setup" instructions below. For a more complete setup, follow the instructions and guides covered in the remaining subsections.

### Quick setup

The following steps describe briefly how to setup your CLM projector in a table mount front projection. Note that each step refers to a corresponding procedure, which is more detailed and illustrated.

1. Install the batteries of the remote control, see "RCU battery installation", page 20.
2. Place the projector on a solid table in front of the screen at the expected throw distance. Ensure that the projector is installed at right angles (horizontally and vertically) with the screen.
3. Select and install an appropriate lens, which covers the throw ratio ( $= \text{screen size} / \text{projector screen distance}$ ). For more details see "Lens selection", page 23.
4. Connect the projector with the local power net, see "Power connection", page 35.
5. Connect your source to the appropriate input module, see "Input source connections", page 37.
6. Switch ON the projector, see procedure "Switching on", page 45.
7. Select the input slot at which your source is connected with. Do this by pressing the numeric key "1" or "2" on the remote control unit or on the local keypad, see "Source selection", page 53.
8. Zoom and shift the lens until the image is properly projected on the screen, Do this by using the "ZOOM" and "FOCUS" key on the remote control unit or on the local keypad, see "Quick Lens Adjustment via LENS key", page 48 or "Direct Lens Adjustment (RCU)", page 49. If necessary, level the projector from side to side by turning the adjustable feet in or out, see "Alignment of a table mounted CLM projector", page 24.

### Overview

- Remote control unit (RCU)
- Lenses
- Alignment of a table mounted CLM projector
- Suspension of the CLM projector with rigging clamps
- Alignment of a ceiling mounted CLM projector

## 3.1 Remote control unit (RCU)

### Introduction

The standard remote control unit (A) can be equipped with the optional rugged case (B) and an XLR adapter (C).

The remote control unit can be used wired via mini-jack or via optional rugged XLR. Note that the backlight of the remote control unit illuminate continuously when used with a wire.

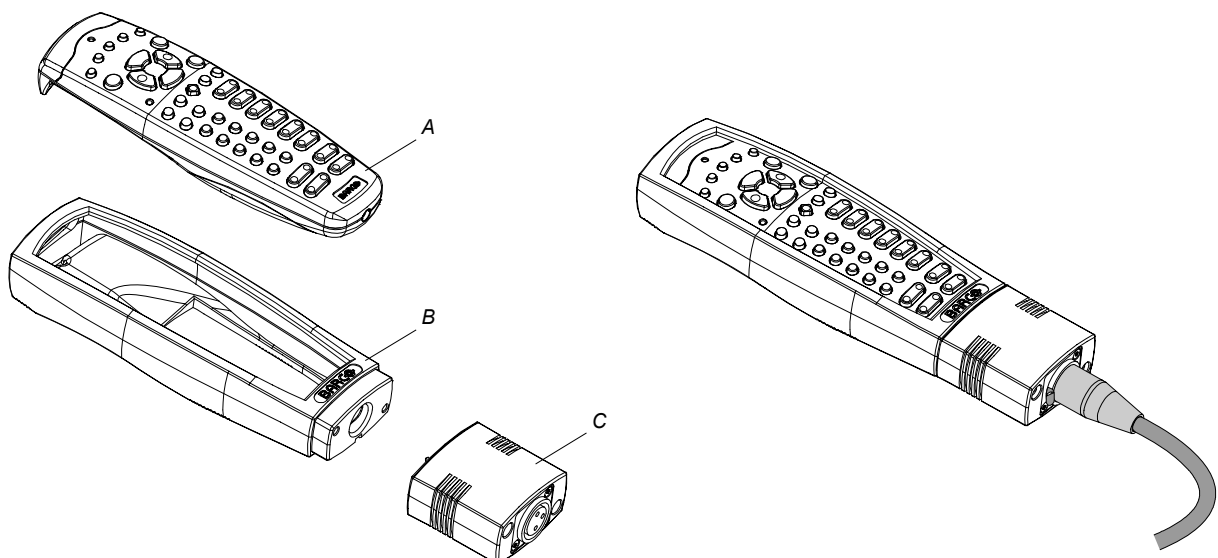

Image 3-1

#### Overview

- RCU battery installation
- RCU rugged case installation
- RCU XLR adaptor installation
- Using the XLR adaptor of the RCU
- RCU usage possibilities

#### 3.1.1 RCU battery installation

##### Where to find the batteries for the remote control ?

The batteries are not placed in the remote control unit to avoid control operation in its package, resulting in a shorter battery life time. At delivery the batteries can be found in a separated bag attached to the remote control unit. Before using your remote control, install the batteries first.

##### How to install the batteries in the remote control ?

1. Push the battery cover tab with the fingernail a little backwards (1) and pull, at the same time, the cover upwards (2).

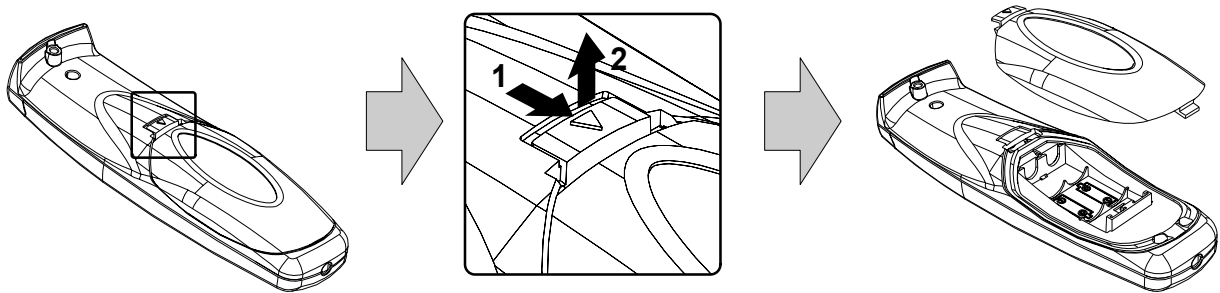

Image 3-2

2. Insert the two AA size batteries, making sure the polarities match the + and - marks inside the battery compartment.

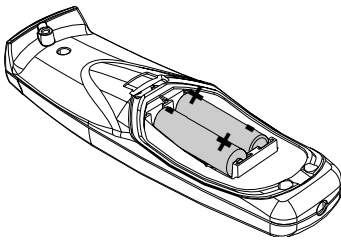

Image 3-3

3. Insert (1) the lower tab of the battery cover in the gap at the bottom of the remote control, and press (2) the cover until it clicks in place.

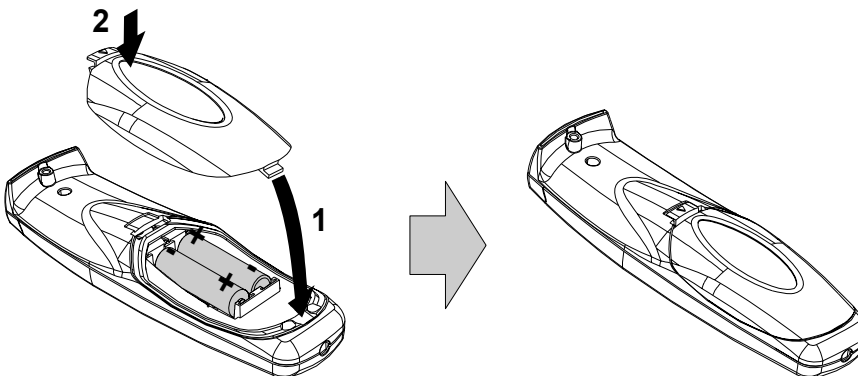

Image 3-4

##### To prevent battery explosion

- Danger of explosion if battery is incorrectly installed.
- Replace only with the same or equivalent type recommended by the manufacturer.
- Disposal of used batteries must be done according to the manufacturer's instruction.



### 3.1.2 RCU rugged case installation



Only with optional rugged case kit which is part of the touring kit (R9861000).

#### Necessary tools

No tools.

#### Necessary parts

Touring kit

#### How to install the rugged case of the remote control ?

1. Slide the bottom of the RCU into the rugged case and then pull the top of the rugged case over the top of the RCU as illustrated.

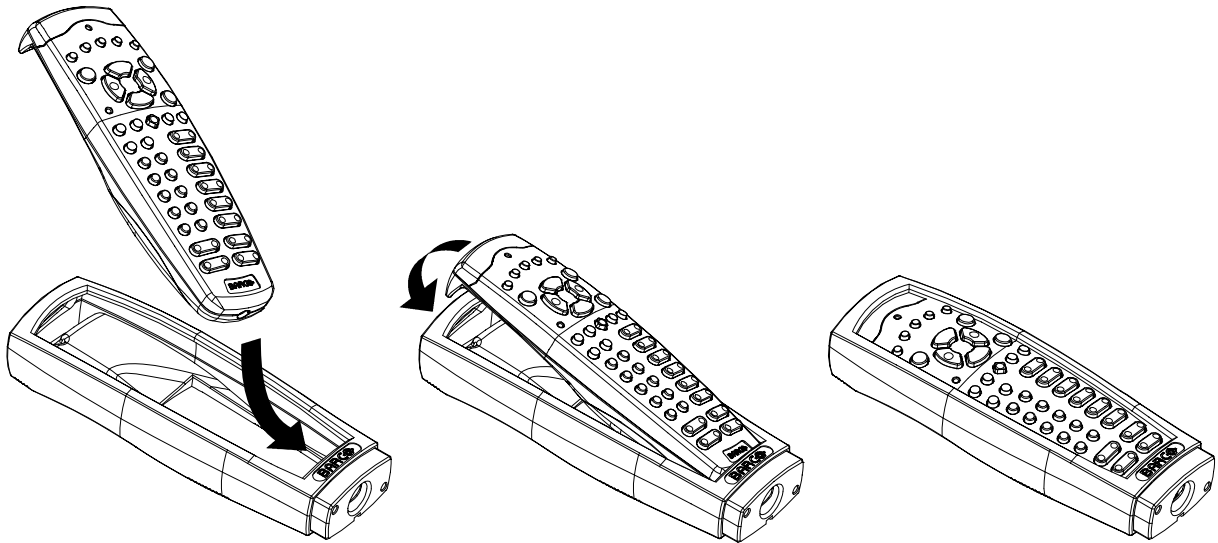

Image 3-5

### 3.1.3 RCU XLR adaptor installation



Install the rugged case before installing the XLR adaptor. Vice-versa, remove the XLR adaptor before removing the rugged case from the RCU.

#### Necessary tools

5 mm flat screw driver.

#### Necessary parts

XLR adaptor (part of the touring kit)

#### How to install the XLR adaptor of the remote control unit ?

1. Push the XLR adaptor (C) upon the rugged case of the remote control unit as illustrated.  
**Note:** Ensure that the text of the XLR adaptor is on top.

### 3. Physical installation

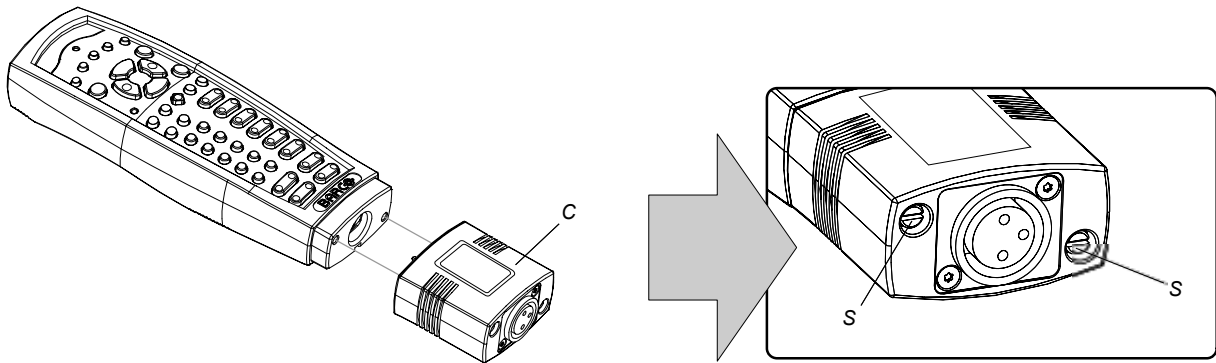

Image 3-6  
Mounting the XLR adapter

2. Fasten the two screws (S) of the XLR adaptor. Turn each screw repeatedly one or two turns until both screws are tight.

#### 3.1.4 Using the XLR adaptor of the RCU

##### How to use the XLR adaptor of the remote control unit ?

1. Connect a cable with XLR plug into the XLR adaptor.
2. Connect the other end of the cable with your CLM HD8.
3. Push the XLR adaptor completely against the rugged case of the remote control unit, as illustrated in the left image below, for wired communication. Pull out the XLR adaptor (about 8 mm) to switch over to wireless communication.

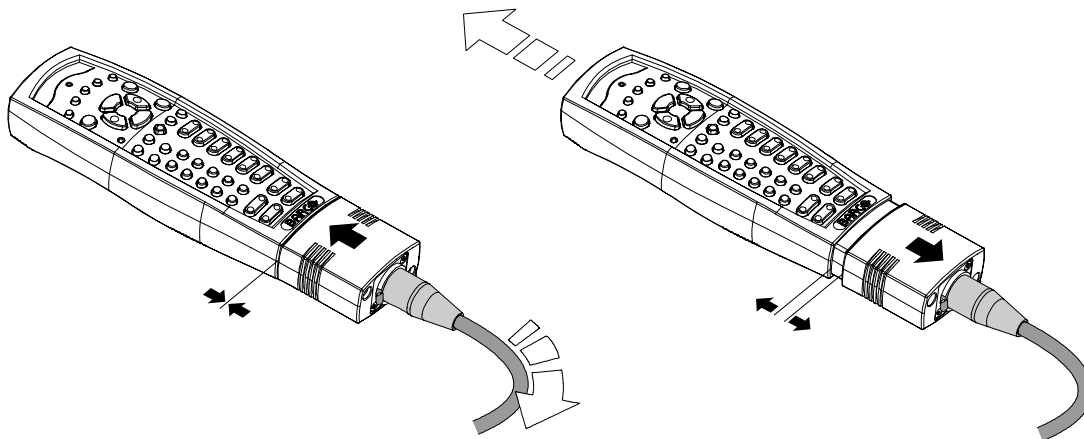

Image 3-7

#### 3.1.5 RCU usage possibilities

##### Summarized possibilities

Ref.	Possibility description	Comment
a.	RCU not wired	
b.	RCU wired (mini-jack)	Backlight illuminates continuously when wire is connected. Infra red disabled.
c.	RCU with rugged case not wired	
d.	RCU with rugged case wired (mini-jack)	Backlight illuminates continuously when wire is connected. Infra red disabled.
e.	RCU with rugged case and XLR adaptor pulled out "REMOTE" and not wired	The XLR adaptor must be in the pulled out position "REMOTE", otherwise the RCU will not function.
f.	RCU with rugged case and XLR adaptor pulled out "REMOTE" and wired	The RCU will send the commands via infra red to the projector.
g.	RCU with rugged case and XLR adaptor pushed in "WIRED" and wired	The RCU will send the commands via the cable connected with the XLR adaptor to the projector. Backlight illuminates continuously when wire is connected. Infra red disabled.

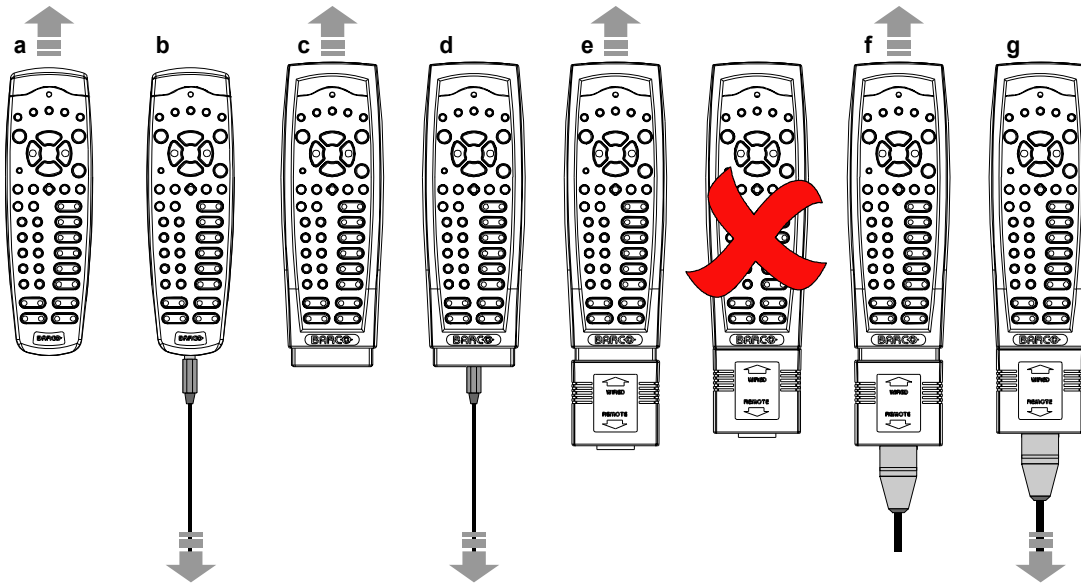

Image 3-8

## 3.2 Lenses

### Overview

- Available lenses
- Lens selection
- Lens formulas

### 3.2.1 Available lenses

#### Overview

Lens	Order number
CLD 1.2 - 1.5	R9861060
CLD 1.5 - 2.2	R9861070
CLD 2.2 - 4.4	R9861080
CLD 4.4 - 7.0	R9861090

### 3.2.2 Lens selection

#### How to select the right lens for your application

1. Determine the required screen width (SW).
2. Determine the position of the projector in the projection room with regard to the screen and measure the projector-screen distance (PD).
3. Use the lens formulas to find the best corresponding PD with regard to the measured projector-screen distance for the required screen width SW.

**Tip:** Divide PD by SW to determine the approximate throw ratio. Choose a Lens, which captures the calculated throw ratio. Use the lens formula of the chosen Lens to recalculate exactly.

### 3. Physical installation

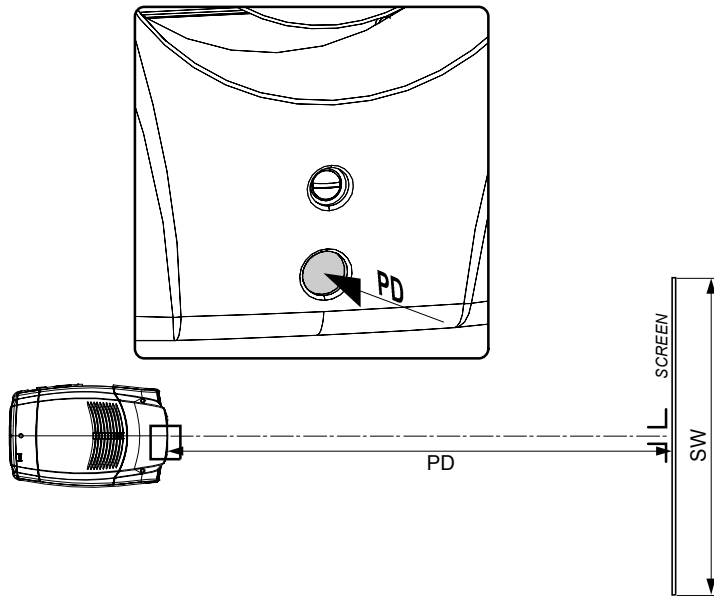

Image 3-9  
PD for lens selection

#### 3.2.3 Lens formulas

##### Formulas

Lens	Throw ratio for CLM HD8	Metric formulas (meter)	Inch formulas (inch)
CLD (1.2 - 1.5 : 1)	1.15 - 1.46	$PD_{min}=1.15 \times SW - 0.13$ $PD_{max}=1.46 \times SW - 0.05$	$PD_{min}=1.15 \times SW - 5.12$ $PD_{max}=1.46 \times SW - 1.97$
CLD (1.5 - 2.2 : 1)	1.45 - 2.18	$PD_{min}=1.45 \times SW - 0.01$ $PD_{max}=2.18 \times SW - 0.53$	$PD_{min}=1.45 \times SW - 0.39$ $PD_{max}=2.18 \times SW - 20.87$
CLD (2.2 - 4.4 : 1)	2.07 - 4.12	$PD_{min}=2.07 \times SW - 0.07$ $PD_{max}=4.12 \times SW - 0.13$	$PD_{min}=2.07 \times SW - 2.76$ $PD_{max}=4.12 \times SW - 5.12$
CLD (4.4 - 7.0 : 1)	4.07 - 6.39	$PD_{min}=4.07 \times SW - 0.25$ $PD_{max}=6.39 \times SW - 0.04$	$PD_{min}=4.07 \times SW - 9.84$ $PD_{max}=6.39 \times SW - 1.58$



**CAUTION:** Never transport the projector with a Lens mounted in the Lens Holder. Always remove the Lens before transporting the projector. Neglecting this can damage the Lens Holder and Prism.

### 3.3 Alignment of a table mounted CLM projector

#### How to align a table mounted CLM projector

1. Place the projector in the desired location. Take into account the zoom range of the used lens and the size of the screen.
2. Project one of the internal hatch patterns on the screen.
3. Turn the adjustable feet in or out until the projected hatch pattern is perfectly rectangle shaped and leveled.

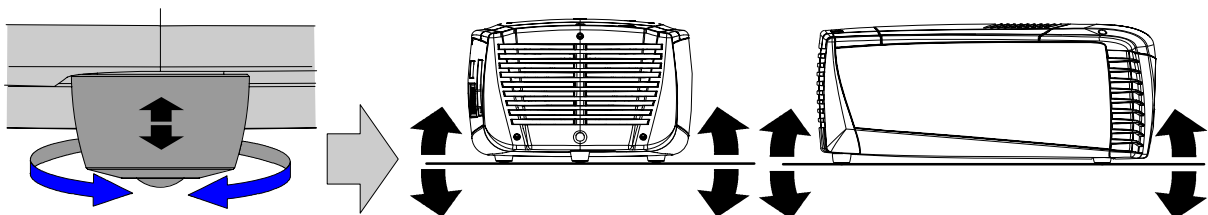

Image 3-10  
Level adjustment

When this is achieved, the projector is set horizontal and vertical at right angles to the screen.

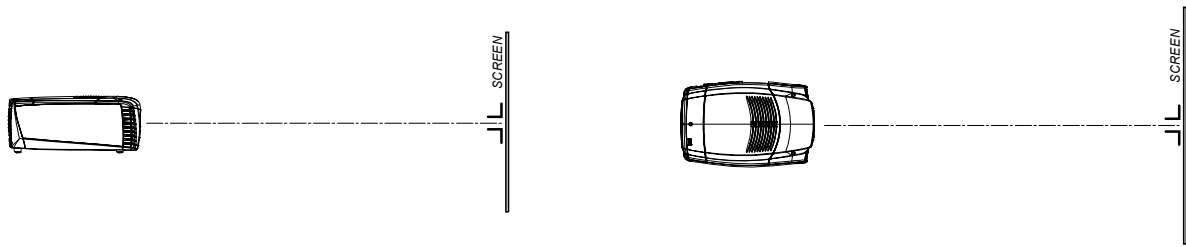

Image 3-11

### 3.4 Suspension of the CLM projector with rigging clamps



Before the projector can be suspended, the optional carry handle must be mounted on the projector. For more information about the optional carry handle, see "Mounting optional Carry handle", page 211.



**CAUTION:** Consult a professional structural engineer to ensure that the suspension system is suitable for this task.

#### Rigging points and rigging clamps

The carry handle is provided with six slots. Four slots are longitudinally oriented (A) and two slots are transversely oriented (B). In each slot, a rigging point can be inserted (this rigging point is mounted on the clamps) and the position in the slot can be adjusted depending of the size of the truss installation. The rigging clamps turn in these rigging points and these clamps allow an easy and fast physical setup of the projector in a hanging configuration.

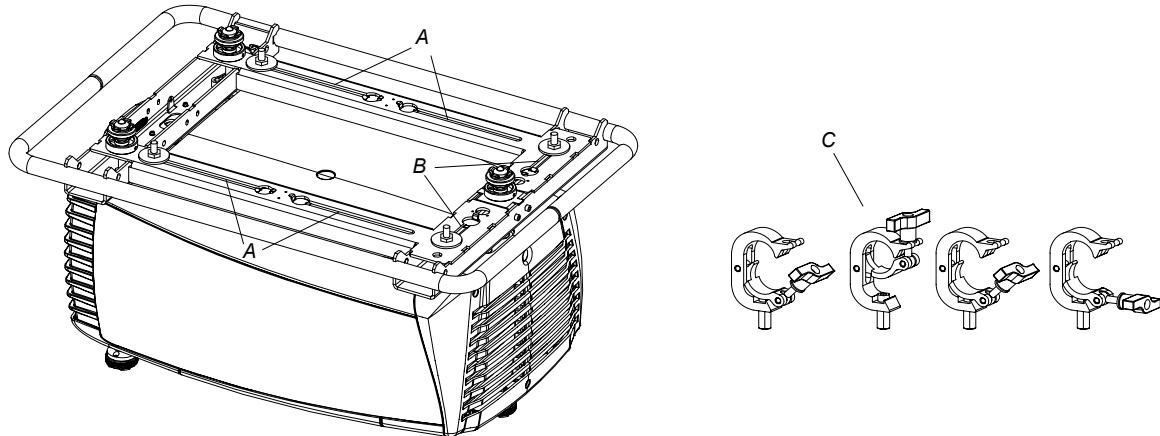
Image 3-12  
Rigging slots and clamps

#### Necessary tools

Open end spanner 17 mm

#### Necessary parts

- Four rigging clamps (R855943)
- Safety cable (B361213)
- Two snap hook locks (B361212)

#### Mounting the rigging points into the handle

1. Push the cup square neck bolt through the slot input and slide the bolt into the slot.

**Note:** Take the bolt by its thread so that it does not fall inside the carry handle.

### 3. Physical installation

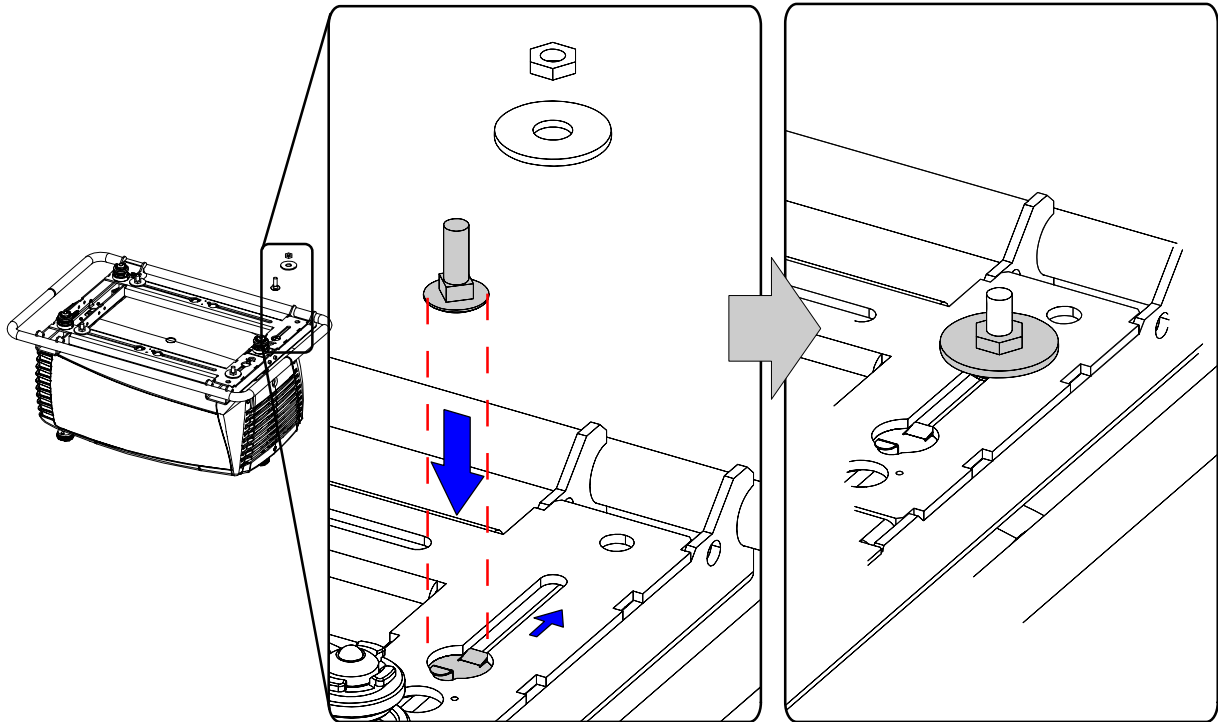

Image 3-13  
Mount rigging points

The cover plate will move down while pushing with the head but comes back to its position once the bolt is in the slot.

2. Slide a washer on the bolt and turn on a nut.
3. Measure the distance, center tube as reference, between the two used support bars of the truss.

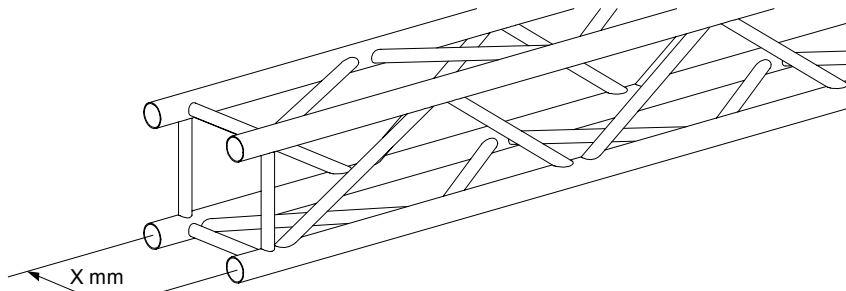

Image 3-14

4. Slide the rigging points on there place in the slots, according the measured distance and secure this position by fastening the nut completely. Ensure that the rigging points are symmetrically lined up, so that the projector will hang in balance. If necessary move point B from a transversal position to a longitudinal position.

**Warning:** Always secure the rigging points after adjustment.

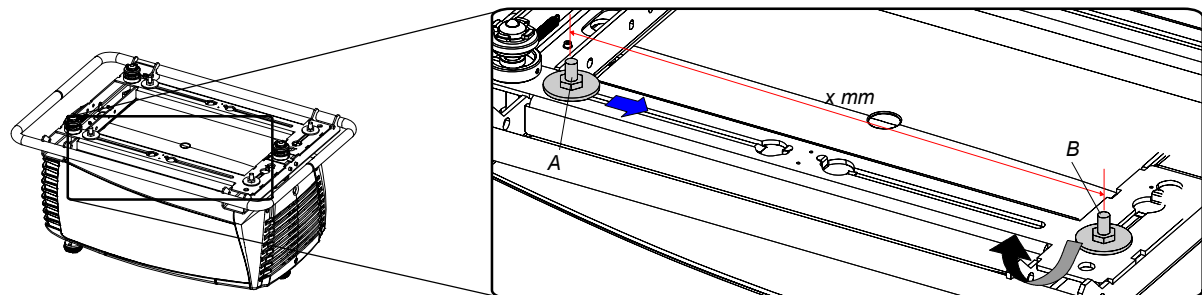

Image 3-15  
Set up truss width

5. Turn the rigging clamps on the bolts.

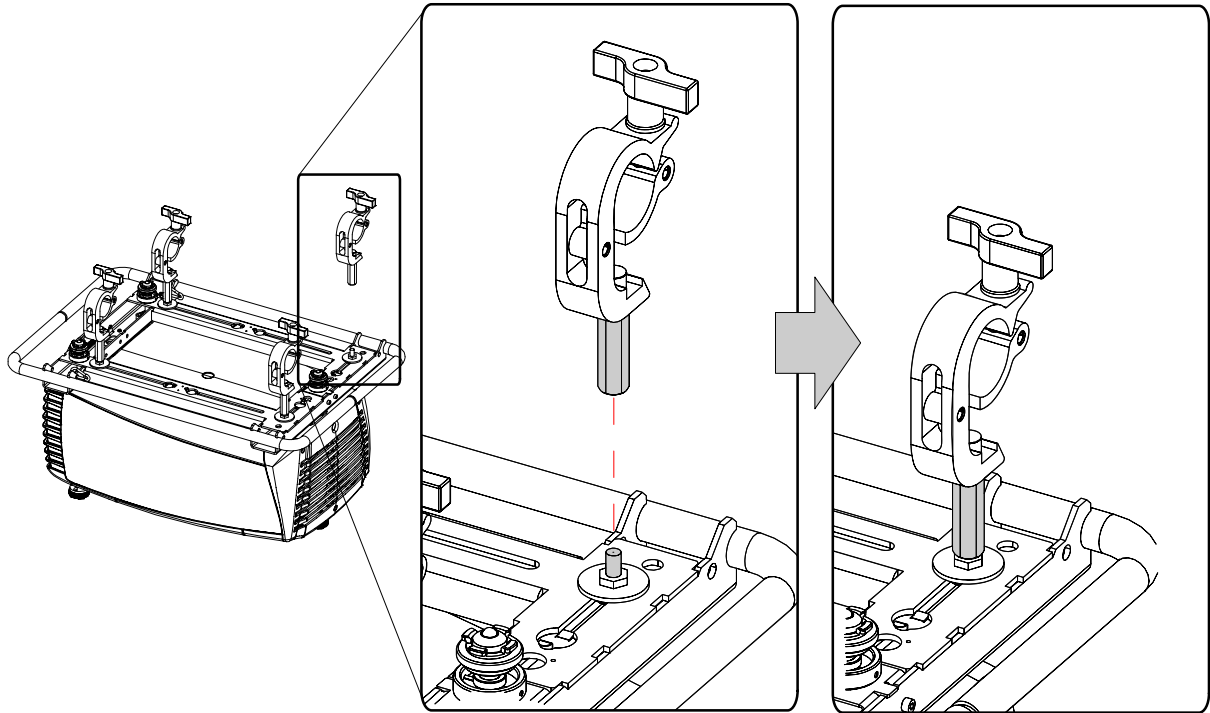

Image 3-16  
Mounting rigging clamps

6. Place all four rigging clamps in open position as illustrated.

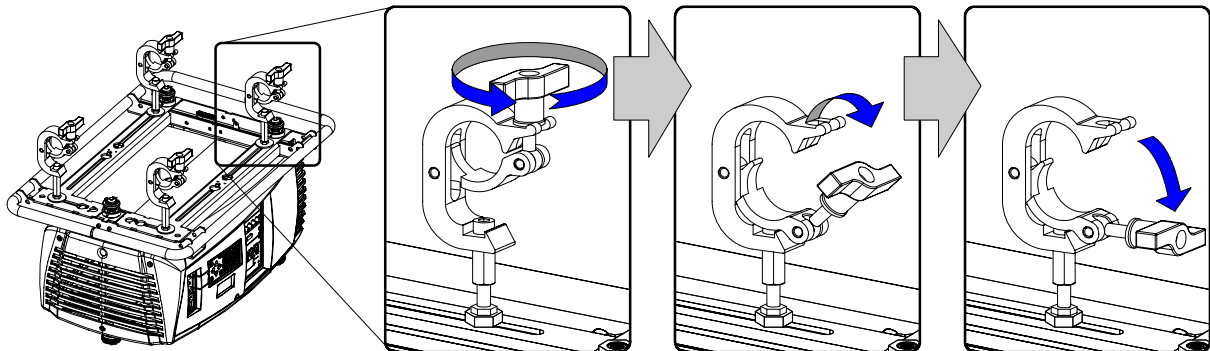

Image 3-17  
Opening clamps

7. Place the projector (upside down) under the truss installation and lower the truss until the support bars of the truss are nearby the rigging clamps on the projector.

### 3. Physical installation

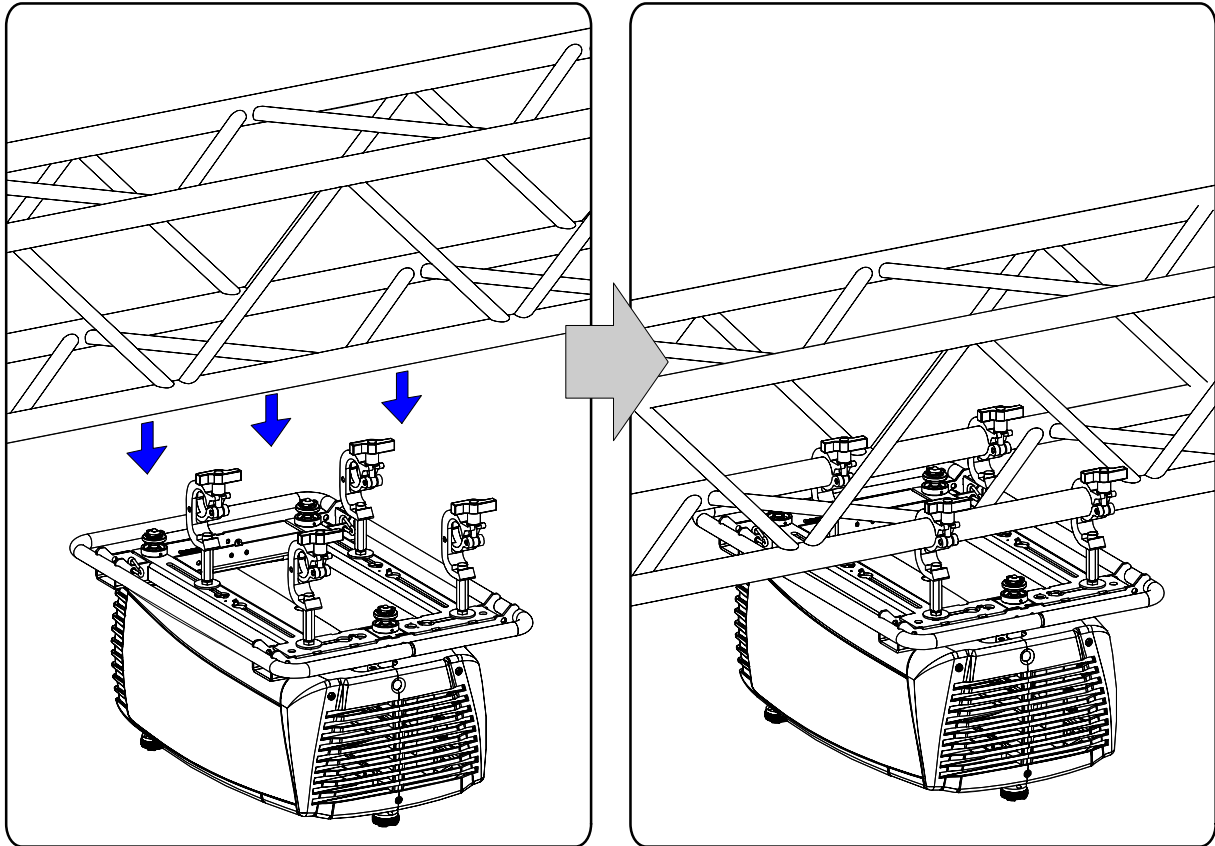

Image 3-18  
Mounting to truss

8. Lift up the projector and hook the four rigging clamps over the support bars of the truss.
9. Lock all four rigging clamps.
10. Install the safety cable. Hook one end into a provided hole. Route the cable around the truss and hook the other end into a second hole in the carry handle.

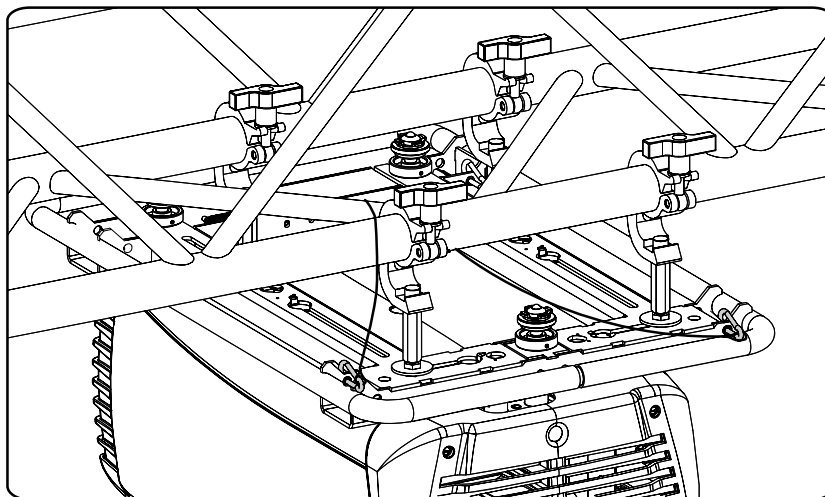

Image 3-19  
Security cable



**CAUTION:** Always mount the safety cable when suspending the projector.



### 3.5 Alignment of a ceiling mounted CLM projector

#### Necessary tools

Spanner 17 mm

#### How to align a ceiling mounted CLM projector

1. Install the projector in the desired location. See "Suspension of the CLM projector with rigging clamps", page 25. Take into account the zoom range of the used lens and the size of the screen.
2. Project one of the internal hatch patterns on the screen.
3. Adjust the height of the rigging clamps with respect to the projector, until the projected hatch pattern is rectangle shaped and leveled. Separate skew adjustment is still possible.

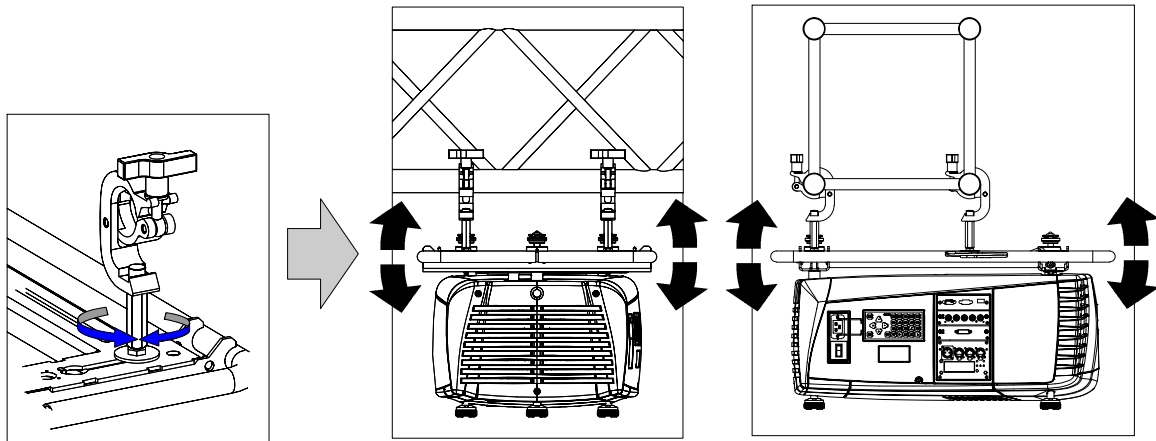

Image 3-20  
Ceiling mount alignment

4. Adjust the skew adjustment until the rectangle is perfectly shaped.

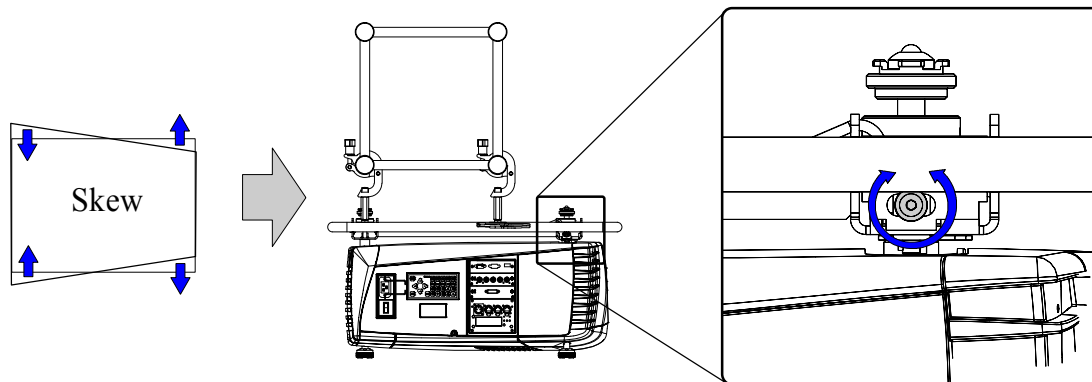

Image 3-21  
Skew adjustment



## 4. STACKING CLM PROJECTORS



Stacking of CLM projectors is only possible with optional touring kit. See "Mounting optional Carry handle", page 211 for more information.

### Overview

- Stacking CLM projectors
- Aligning stacked CLM projectors

### 4.1 Stacking CLM projectors

#### Preparations

Install first a carry handle on the upper projector.

Install at minimum the 3 locking points on the lower projector or install a complete carry handle kit.

#### How to stack CLM projectors

1. Place the projectors on top of each other. Ensure that all three interlocking pins (A) match with their corresponding interlocking sockets (B).

**Tip:** In case of stacking projectors for a ceiling mount configuration, first turn the projectors upside down before placing the projectors on top of each other.

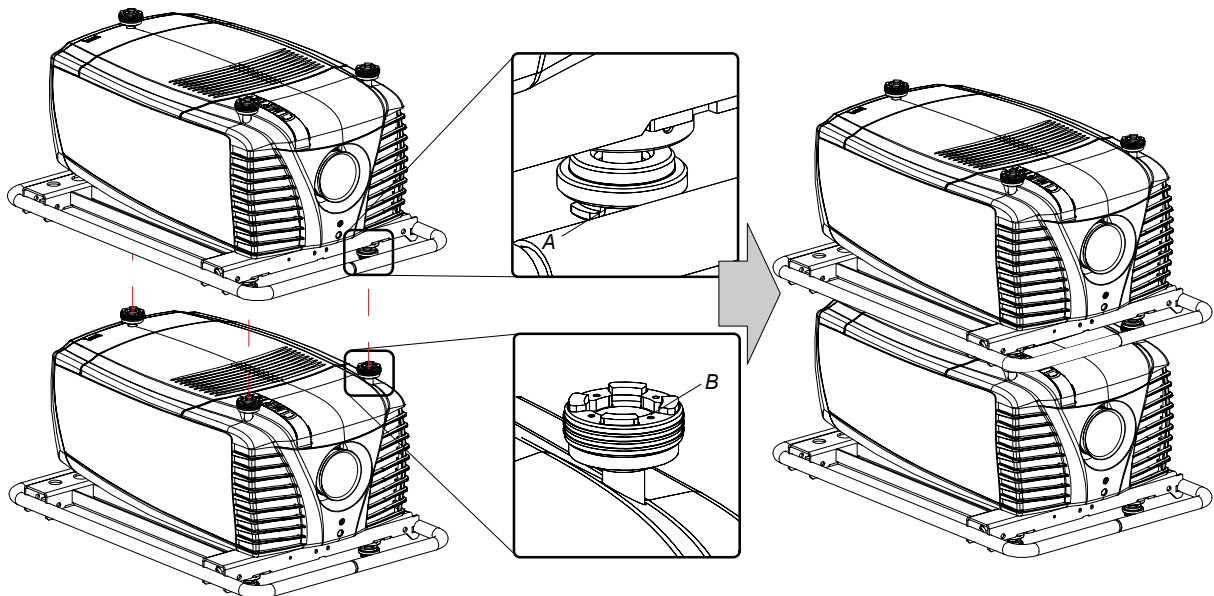

Image 4-1  
Stacking projectors

2. Attach the two projectors together by closing all three interlocking adapters as illustrated.

#### 4. Stacking CLM projectors

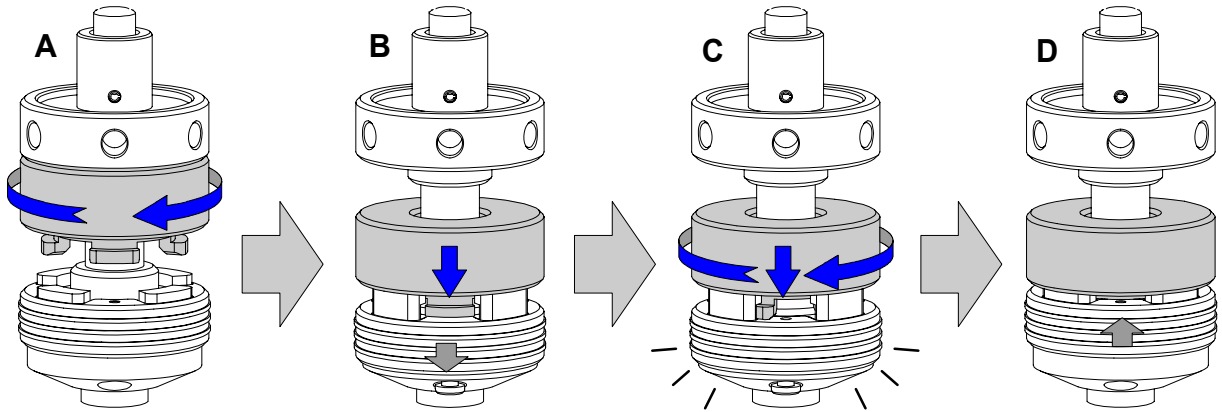

Image 4-2  
Close the interlocking

#### 3. Are these projectors stacked for a ceiling mounted configuration?

If yes, mount a safety cable from one side of the projector around the truss installation to the other side of the projector. Repeat this for the second projector.

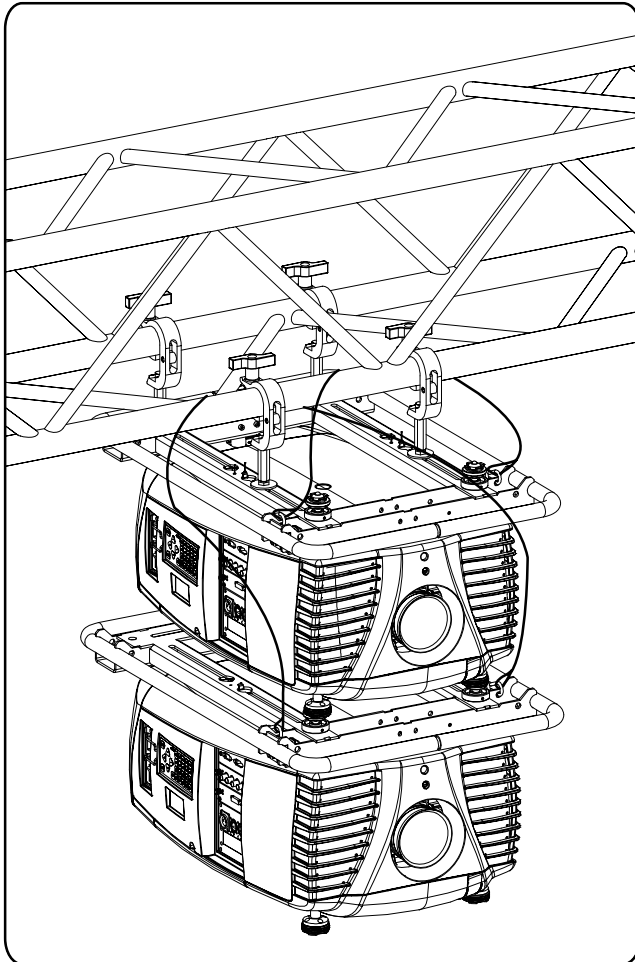

Image 4-3  
Ceiling mounted stacked projectors

#### How to open an interlocking adapter

1. Open an interlocking adapter as illustrated.

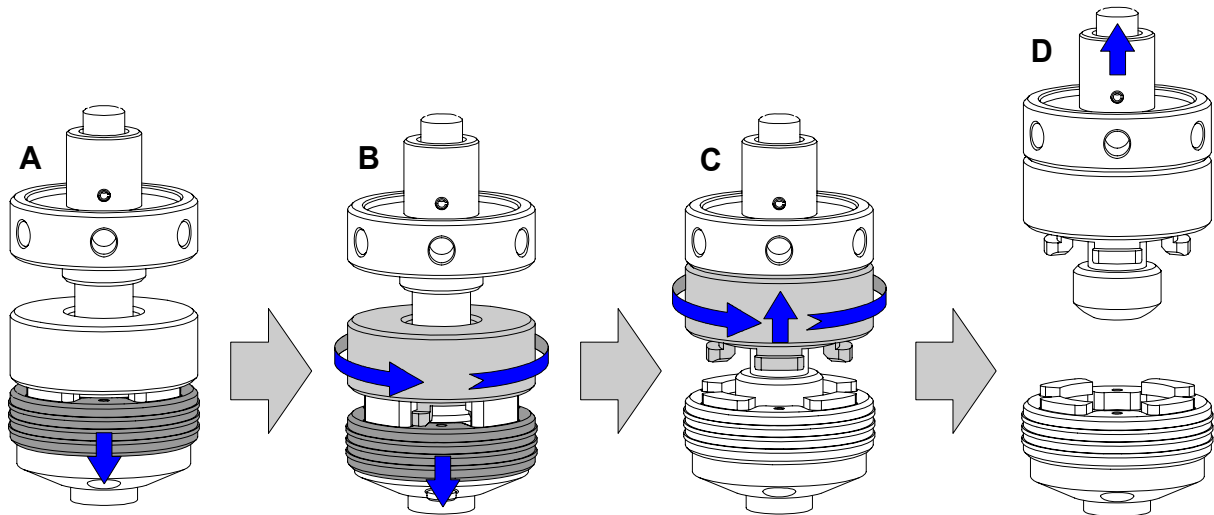

Image 4-4  
Open the interlocking



**WARNING:** Never open an interlocking adapter of a stacked projector which is still suspended. First place the stacked projectors on the floor.

## 4.2 Aligning stacked CLM projectors

### How to align two stacked CLM projectors

1. Make sure that the internal hatch pattern projected by the reference projector is sharp and has a perfect rectangle outline. If this is not the case, readjust the reference projector before aligning the other stacked projector(s) with the reference hatch pattern.  
**Note:** The reference projector in a stacked configuration is the lowest projector in case of table mount and the uppermost projector in case of ceiling mount.
2. Project with the stacked projector the same internal hatch pattern as the reference projector.  
**Tip:** Use a white colored hatch pattern for the reference projector and e.g. green colored for the stacked projector. This makes it easier to see the difference between both hatch patterns projected.
3. If necessary, adjust the rotation of the stacked projector with respect to the reference projector by turning in or out the height adjustment ring of the interlocking adapters at the front of the stacked projector. Adjust until the outline of the hatch pattern is most symmetric with the reference hatch pattern.  
**Tip:** You can increase leverage by using a screw driver in the holes of the adjustment ring

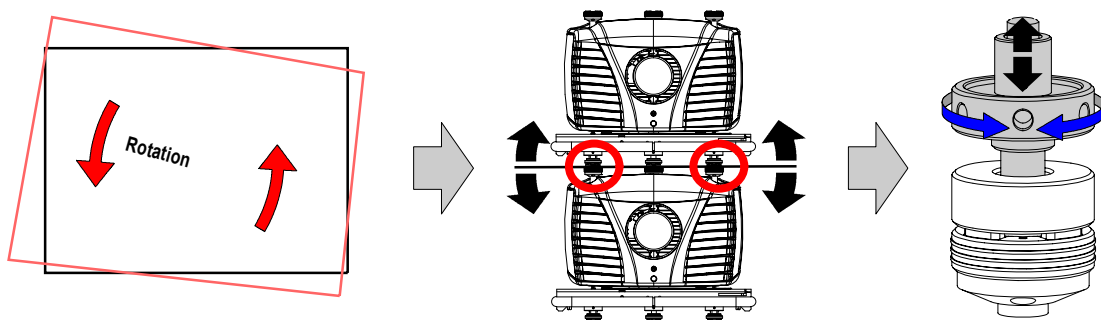

Image 4-5  
Rotation adjustment

4. If necessary, adjust the inclination of the stacked projector with respect to the reference projector by turning the height adjustment ring of the interlocking adaptor at the rear of the stacked projector in or out. Adjust until the outline of the hatch pattern is most symmetric with the reference hatch pattern.

#### 4. Stacking CLM projectors

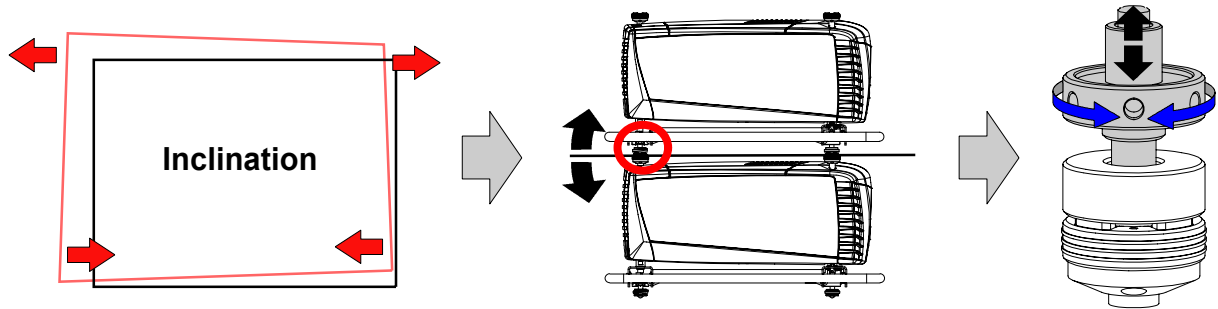

Image 4-6  
Inclination adjustment

5. If necessary, adjust the skew of the stacked projector with respect to the reference projector by turning the screw on the right front side. Adjust until the outline of the hatch pattern is most symmetric with the reference hatch pattern.

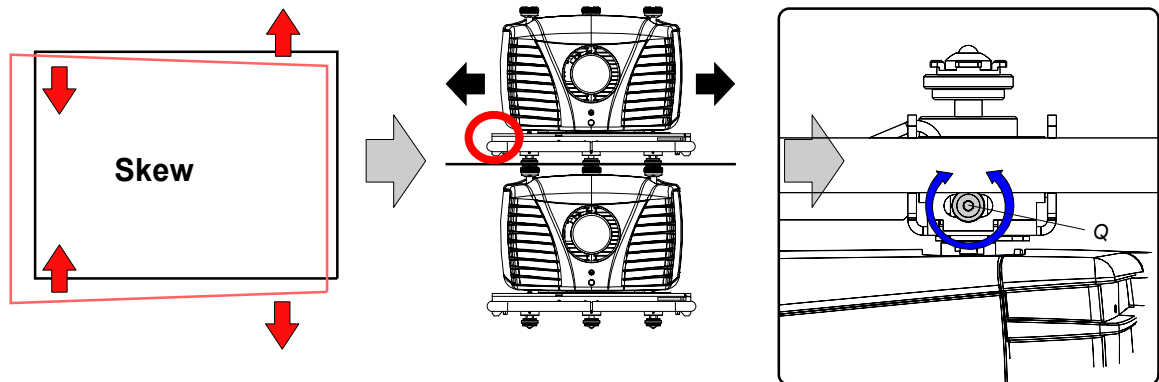

Image 4-7  
Skew adjustment

6. Shift the hatch pattern horizontally and vertically until the outline of the hatch pattern is most symmetrically placed with respect to the reference hatch pattern.

**Note:** Note that the "Shift" function is motorized, which means that you have to access the projector software, via the local keypad or remote control unit, to operate the "Shift" function.

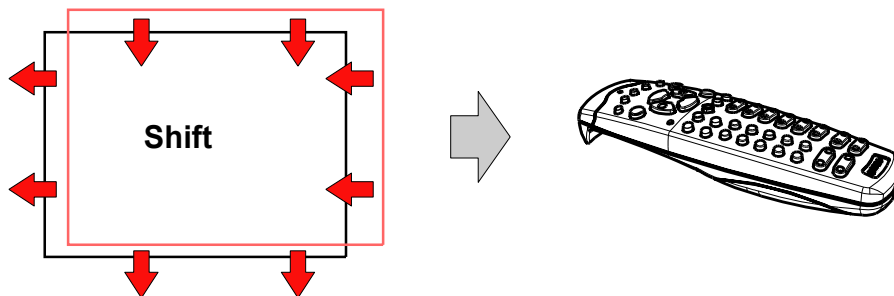

Image 4-8  
Shift adjustment

7. Zoom the hatch pattern in or out until the outline of the hatch pattern matches exactly the outline of the reference hatch pattern.

**Note:** Note that the "Zoom" function is motorized, which means that you have to access the projector software, via the local keypad or remote control unit, to operate the "Zoom" function.

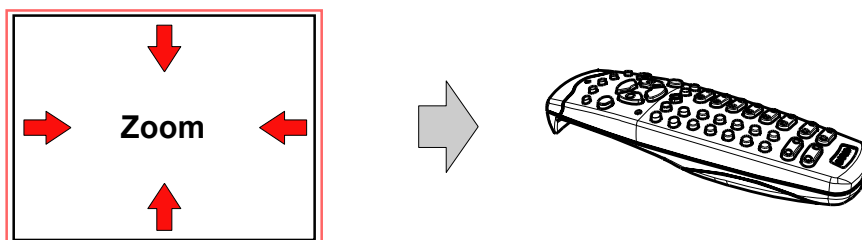

Image 4-9  
Zoom adjustment

## 5. CONNECTIONS

### About this chapter

This chapter describes more in detail the power (P), the input source (S) and the communication (C) connections of the CLM HD8.

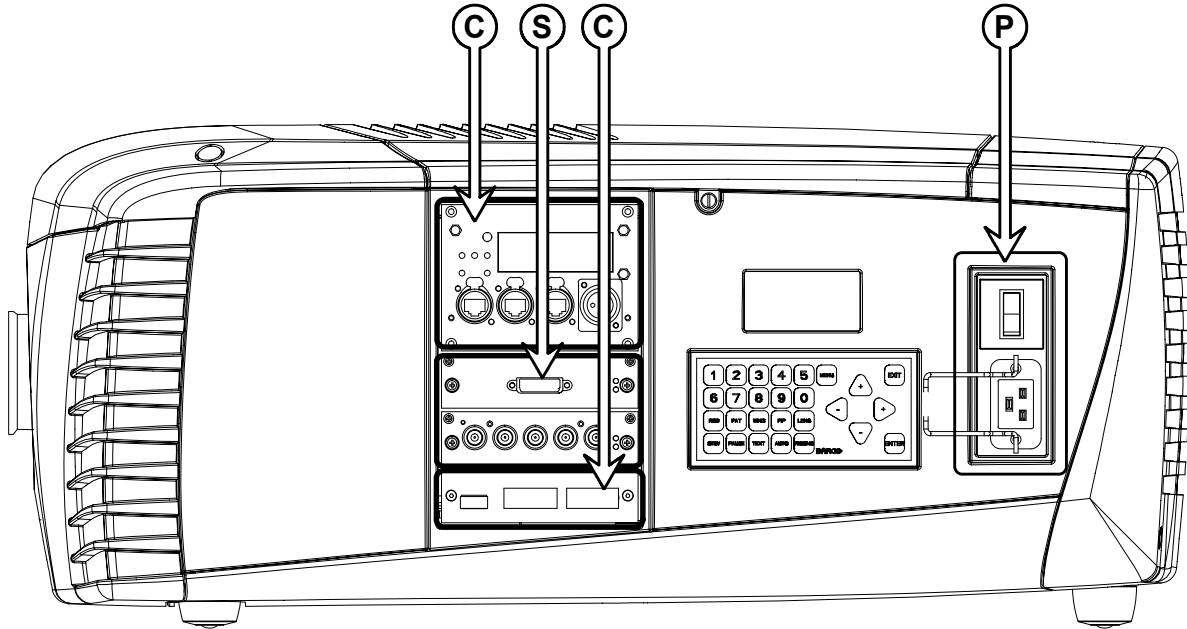

Image 5-1

### 5.1 Power connection



**CAUTION:** Use only the power cord provided with the projector.

#### How to connect with the local power net

1. Ensure that the power switch (S) stands in the "0" (OFF) position.
2. Connect the power cord with the power input socket of the projector (P).
3. Secure the power plug by locking the plug holder clamp (H).

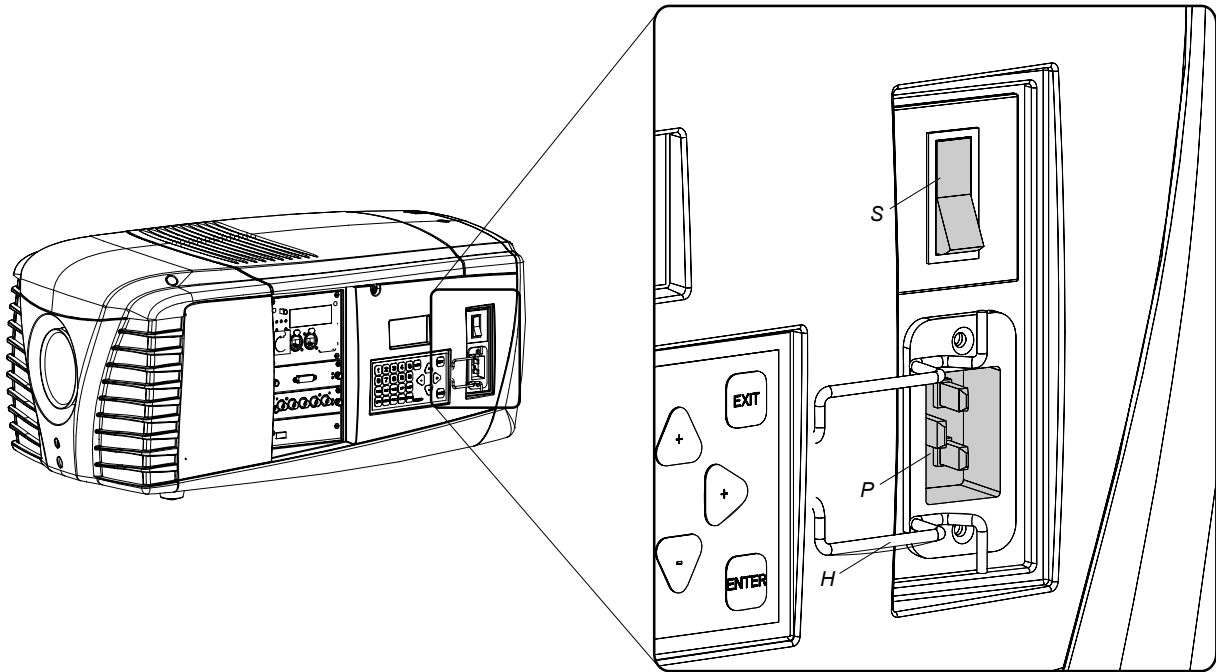

Image 5-2  
Power input

4. Connect the male side of the power cord to the local power net.

**Caution:** Ensure that the power net meets the power requirements of the projector.

For order number R9050130 and R90501301 100-120/200-240V 12/8A 50/60Hz

For order number R90501305 : 100-120/200-240V 16/8A 50/60Hz



**WARNING:** Do not attempt operation if the AC supply and cord are not within the specified voltage and power range.



**CAUTION:** Once the projector is switched to standby, the lamp cooling fans will continue to run for approximately five minutes to ensure that the projector and lamp have sufficiently cooled, at which point the fans will automatically decrease to standby. To avoid thermal stress that can lead to premature lamp failure, never unplug the power cord while the lamp cooling fans are running. Never unplug the power cord to power down the projector, first switch off the power switch and then unplug the power cord.

## Fuses

The projector with order number R9050130 and R90501301 is protected with an automatic circuit breaker of 15 A and projector with order number R90501305 is protected with an automatic circuit breaker of 20A. The circuit breaker is built in into the power switch.

## Power input voltage versus light output (for R9050130 and R90501301)

When the input power is between 170V and 264V the maximum light output with 4 lamps can be reached.

In the low input power ranges the light output will be reduced to protect the projector.

When the input power is between 100V and 140V, 75% of the light output with 3 lamps can be reached.

When the input power is between 90V and 100V the light output is reduced to 62.5% with only 3 lamps.



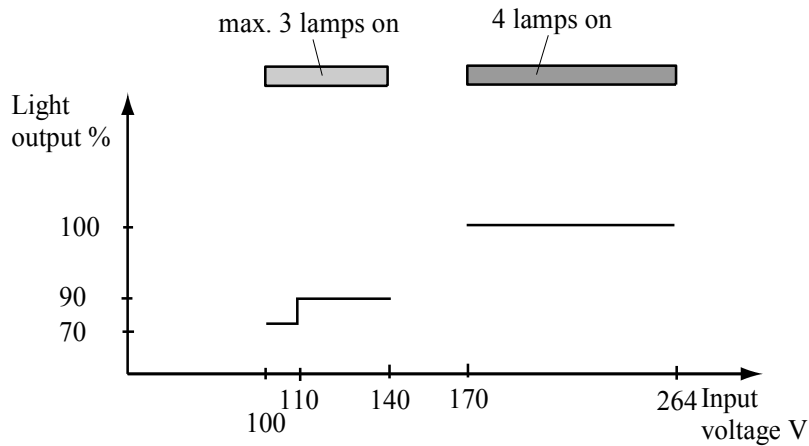

Image 5-3

### Power input voltage versus light output (for R90501305)

Input power between 100V and 264V, the maximum light output with 4 lamps can be reached.

Input power between 90V and 99V, 83% of the light output with 4 lamps.

## 5.2 Input source connections

### General

The input and communication unit is equipped with two input slots, which accept any type of input designed for the CLM projector. The modularity of the input modules makes the CLM projector very flexible regarding input source connectivity. Note that the slot numbering is done from top to bottom. So, the uppermost slot is slot number "1", the second is slot number "2". All input modules have two status LED's. The green LED lights up if the input module is selected as the active input module. The yellow LED lights up if the input module has detected valid input syncs.

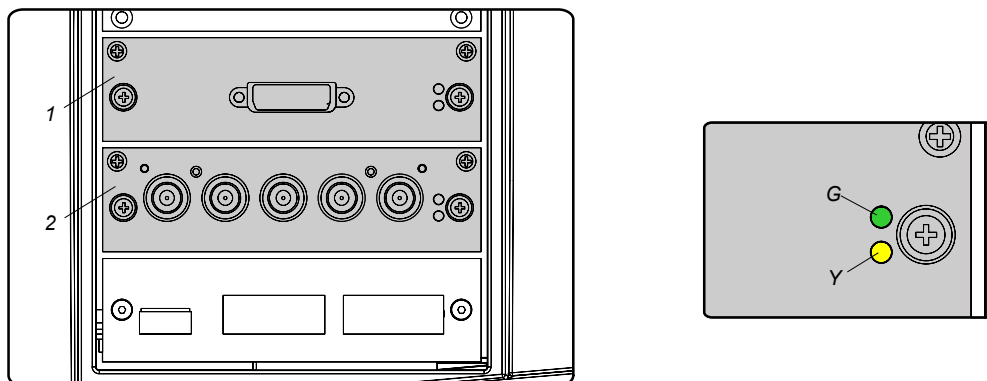

Image 5-4



**CAUTION:** Always install a cover plate on an unused input slot. This to prevent dust intrusion into the projector.

### Available input modules



Image 5-5  
5 Cable input (Multi purpose) (R9854430).



Image 5-6  
HDSDI - SDI input (R9854450).



Image 5-7  
DVI input (R9854460).



Image 5-8  
HDCP DVI input (R9854465)



Image 5-9  
Cover plate for unused input slot (R848607).



The CLM HD8 is standard equipped with one 5 cable input module and one SDI/HDSDI input module.

---

## 5.3 Communication connections

### Communication interface

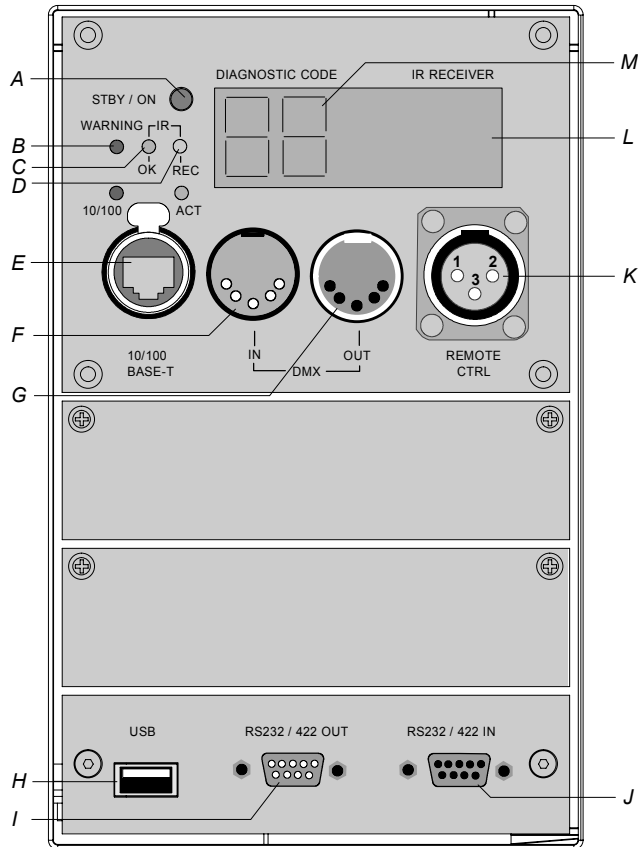

Image 5-10  
Communication connections

- A Projector status LED
- B Warning LED
- C IR signal acknowledged LED
- D IR signal received LED
- E Ethernet port
- F DMX in port
- G DMX out port
- H USB port
- I RS232/422 output port
- J RS232/422 input port
- K XLR input port for remote control
- L IR receiver
- M Two digit 7-segment display for diagnostic code

### Projector status

The projector “status” LED (A) lights up green while in operation. The same LED lights up red when the projector is switched to standby.

Besides the projector status LED (A) the communication interface has also a “warning” LED (B) which blinks in case the projector encounters an internal problem concerning fan speed, temperature, supply voltages, ... etc. These type of problems still allows the projector to operate (the show can go on) but an action will be required within a short time period. More information about the involved problem is given on the local LCD display of the projector.

A two character 7-segment display (M) shows, during normal operation, the selected input slot number. If an error has occurred then an error code appears on this two digit display.

### IR communication (RC5)

An IR receiver (L) is mounted on the communication interface. Note that there is also an IR receiver mounted at the front and at the back of the projector. When using the remote control unit (wired or wireless), the “IR REC” (D) and the “IR OK” (C) LED’s will light up indicating an IR signal was received and recognized.

### Wired remote control

If desired the remote control unit can be wired and plugged in into the male XLR port (K) on the communication interface.

XLR – Remote CTRL in	
Pin	Description
1	GND
2	RC5 in
3	XLR present sense

### RS232/422 serial communication

The communication interface of the CLM HD8 supports RS232 and RS422 serial communication. You can use the RS232/RS422 input port (J) to connect a local PC to your CLM projector. This way you can configure and control your CLM projector from your local PC.



**Do not forget to set the projector's baud rate to match that of the computer.**

The communication interface has also an active RS232/RS422 loop through output port. Whenever the projector has no power, a passive loop through is created from the RS232/RS422 input port to the RS232/RS422 output port. So, the following projector in the daisy chain will still receive his RS232/RS422 commands.

Advantages of using RS232/RS422 serial communication:

- easy adjustment of the projector via PC (or MAC).
- allow storage of multiple projector configurations and set ups.
- wide range of control possibilities.
- address range from 0 to 255.
- sending data to the projector (update).
- copying data from the projector (backup).

RS232/422 input port	
Pin	Description
1	DCD : Data Carrier Detect
2	RXD- : Receive Data
3	TXD- : Transmitted Data
4	DTR : Data Terminal Ready [RS232] TXD+ : Transmitted Data [RS422]
5	GND : Ground
6	DSR : Data Set Ready [RS232] RXD+ : Received Data [RS422]
7	— (not connected) —
8	CTS : Clear To Send
9	RI : Ring Indicator

RS232/422 output port	
Pin	Description
1	— (not connected) —
2	RXD- : Receive Data
3	TXD- : Transmitted Data
4	DTR : Data Terminal Ready [RS232] TXD+ : Transmitted Data [RS422]
5	GND : Ground
6	DSR : Data Set Ready [RS232] RXD+ : Received Data [RS422]
7	— (not connected) —
8	— (not connected) —
9	— (not connected) —

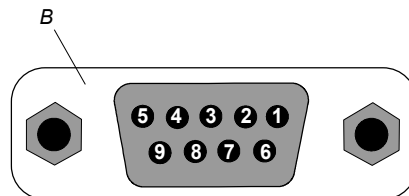
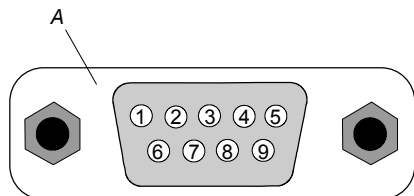

Image 5-11  
 A Pin numbering male DB-9 connector.  
 B Pin numbering female DB-9 connector.

**RS232**

An Electronic Industries Association (EIA) serial digital interface standard specifying the characteristics of the communication path between two devices using either D-SUB 9 pins or D-SUB 25 pins connectors. This standard is used for relatively short-range communications and does not specify balanced control lines. RS-232 is a serial control standard with a set number of conductors, data rate, word length and type of connector to be used. The standard specifies component connection standards with regard to computer interface. It is also called RS-232-C, which is the third version of the RS-232 standard, and is functionally identical to the CCITT V.24 standard. Logical '0' is  $> +3V$ , Logical '1' is  $< -3V$ . The range between  $-3V$  and  $+3V$  is the transition zone.

**RS422**

An EIA serial digital interface standard that specifies the electrical characteristics of balanced (differential) voltage, digital interface circuits. This standard is usable over longer distances than RS-232. This signal governs the asynchronous transmission of computer data at speeds of up to 920,000 bits per second. It is also used as the serial port standard for Macintosh computers. When the difference between the 2 lines is  $< -0.2V$  that equals with a logical '0'. When the difference is  $> +0.2V$  that equals to a logical '1'.

**Ethernet network communication**

The CLM projector can be connected to a LAN (local area network) using the Ethernet port (E) on the communication interface. Once connected to the LAN, users are capable of accessing the projector from any location, inside or outside (if allowed) their company network using the CLM control software: Projector Toolset. This toolset locates the projector on the network in case there is a DHCP server or the user can insert the correct IP-address of the projector to access the projector. Once accessed, it is possible to check and manipulate all the projector settings. Remote diagnostics, control and monitoring of the projector can then become a daily and very simple operation. The network connectivity permits to detect potential errors and consequently improve the time to servicing.

Both Ethernet port (E) is equipped with a yellow and green a LED. The yellow LED lights up in case the port is connected with a 100Mbit network. The green LED blinks in case there is network activity.



**The connector used for the Ethernet ports (E) are of rugged Neutrik EtherCon RJ45 type, which is compatible with standard RJ45 cable connector. Straight (most common) as well as cross linked network cables can be used.**

**10/100 Base-T — RJ45 port**

Pin	Description
1	TXD+
2	TXD-
3	RXD+
4	—
5	—
6	RXD-
7	—
8	—

**USB port**

The communication interface is equipped with a master USB port, type "A" connector (H). This USB port will simplify the service procedures for software updates or for taking backup files from the projector without network connection. An USB-stick is plugged into the USB port and files can be transferred from or to the projector using the local or remote control unit. Note that the USB-stick has to be Linux FAT16 compatible.

**DMX interface**

The communication interface of the CLM HD8 supports DMX.

DMX is used as communication bus between different devices in the light technic. Each device has an input and an output, so that the bus can be looped between the different devices. According the standard a five wire cable with XLR connector is used but mostly 3-wire cables are used.

You can use the DMX input port (G) to connect a DMX device to the CLM projector. This way you can control the CLM projector from that DMX device. The DMX output port (G) can be connected with the next device in the loop.

Pin	Description
1	Earth

## 5. Connections

---

Pin	Description
2	Cold
3	Hot
4	Return - (or not used)
5	Return + (or not used)

---



### **DMX**

DMX-512 Lighting protocol over RS-485 interface. Carries information of 512 channels from a lighting controller to lighting devices. Standardized by USITT.

---

## 6. GETTING STARTED

### About this chapter

This chapter describes the functions on the remote control and local keypad and gives an overview how to start up the projector. It gives also a brief overview of the direct adjustment possible with these controls.

### Overview

- RCU & Local keypad
- Terminology overview
- Operating the projector
- Using the RCU
- Quick setup adjustments
- Use of the AUTO button
- Projector Address
- Source selection
- Controlling the Projector

### 6.1 RCU & Local keypad

---

#### How controlling the projector ?

The projector can be controlled by the local keypad or by the remote control unit.

#### Location of the local keypad ?

The local keypad is located on the input side of the projector.

#### Remote control functions.

This remote control includes a battery powered infrared (IR) transmitter that allows the user to control the projector remotely. This remote control is used for source selection, control, adaptation and set up.

Other functions of the remote control are :

- switching between stand by and operational mode.
- switching to "pause" (blanked picture, full power for immediate restarting)
- direct access to all connected sources.

### 6.2 Terminology overview

---

#### Overview

The following table gives an overview of the different functionality of the keys.

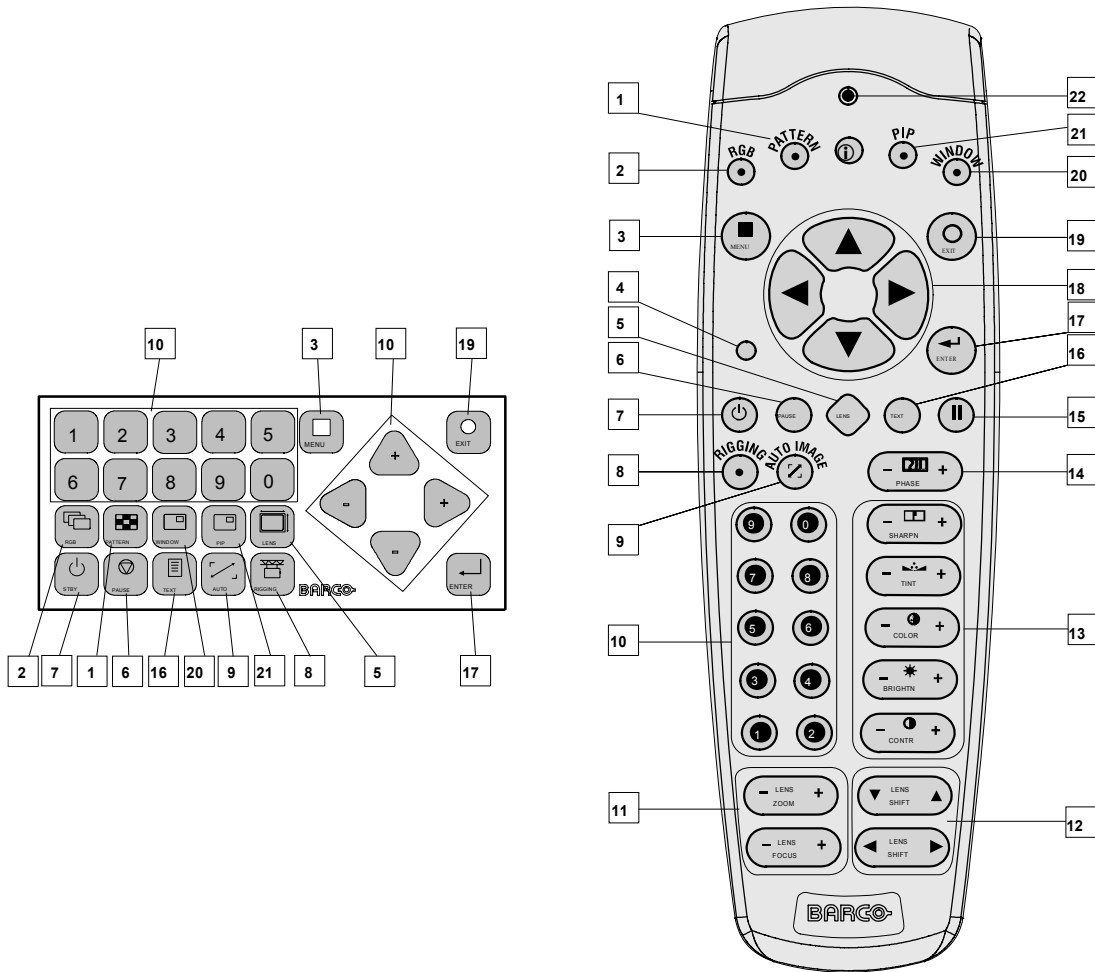

Image 6-1  
Local keypad & remote control

Ind.	Key name	Description
1	Pattern key	Direct access key to the internal pattern selection menu.
2	RGB	Toggle key to enable and disable colors in the adjustment mode. Toggle between red, green, blue and full RGB.
3	MENU	Access key to the menu structure and key to quickly quit the adjustment menus.
4	Address key	(recessed key), to enter the address of the projector (between 0 and 9) in the remote control. Press the recessed address key with a pencil, followed by pressing one digit button between 0 and 9.
5	LENS	Direct access key to the lens adjustment menus. Toggling this key will change the projected pattern.
6	PAUSE	To stop projection for a short time, press 'PAUSE'. The image disappears but full power is retained for immediate restarting. Shutter is closed.
7	STBY	Standby function switch off the lamp and lamp electronics. The lamp cooling fans remain active for about 5 minutes. The speed of the other fans is reduced.
8	Rigging	Direct access key to layout selection. Rigging key + sequence number opens directly the desired layout.
9	Auto	User programmable key to get different functions from auto image, auto contrast/brightness to auto align. This key can open an Auto image menu so that the user has access to these different functions.
10	Digit buttons	Direct input selection or numeric entries
11	Lens zoom/focus	Zoom and focus controls of the lens
12	Lens shift	Shift control of the lens, to shift the lens up/down or left/right
13	Picture controls	Use these buttons to obtain the desired picture level.



Ind.	Key name	Description
14	PHASE	Used to remove the horizontal instability of the image (usually for RGB source). It adjusts the phase of the pixel sampling clock relative to the incoming signal.
15	FREEZ	To freeze the actual projected image. Freeze sign is displayed in the upper left corner (a short press on the key).  When pressing for 5 sec, the projector goes into stand-by. The lamp cooling fans remain active for about 5 minutes. The speed of the other fans is reduced.
16	TEXT	Toggle key to activate or deactivate on screen text boxes while adjusting a setting.  When adjusting one of the image controls, e.g.during a meeting, the normally displayed bar scale can be deactivated by pressing 'TEXT' key first. To re-display the bar scale on the screen, press 'TEXT' key again. When TEXT is 'off', no adjustment menu's will be displayed on the screen when entering the adjustment mode. All menus and adjustments remain active on the local LCD panel.
17	ENTER	Key to confirm an adjustment or selection in the adjustment mode.
18	Cursor keys	To make menu selections when in the adjustment mode
19	EXIT	Key to go one menu stage higher than the actual position when in the adjustment mode.
20	WINDOW	Selection of the active window, also in PIP mode.
21	PIP	Direct access key for picture in picture selection.
22	RC Operating indication	Lights up when a button on the remote control is pressed. (This is a visual indicator to check the operation of the remote control)

Table 6-1

## 6.3 Operating the projector

### Overview

- Switching on
- Errors, warnings and messages during start up
- Switching to standby
- Switching off



**All four lamps must be physically installed before operating the projector.**

### 6.3.1 Switching on

#### How to switch on.

1. Press the power switch to switch on the projector.

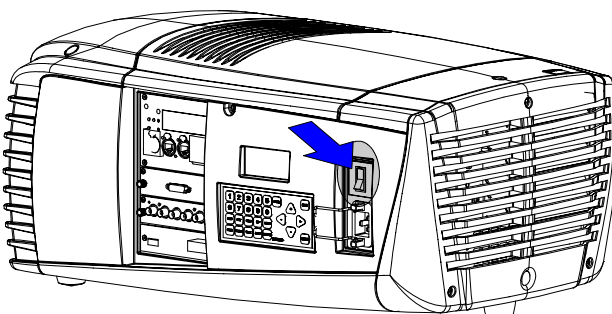

Image 6-2  
Power switch

- When '0' is visible, the projector is switched off.
- When '1' is visible, the projector is switched on.

The projector starts up in standby. The menus are accessible via the local LCD panel.

To display an image, the standby key must be pressed once.

### Starting image projection via the standby key.

1. Press **Stand by** key once on the local keypad or on the remote control.

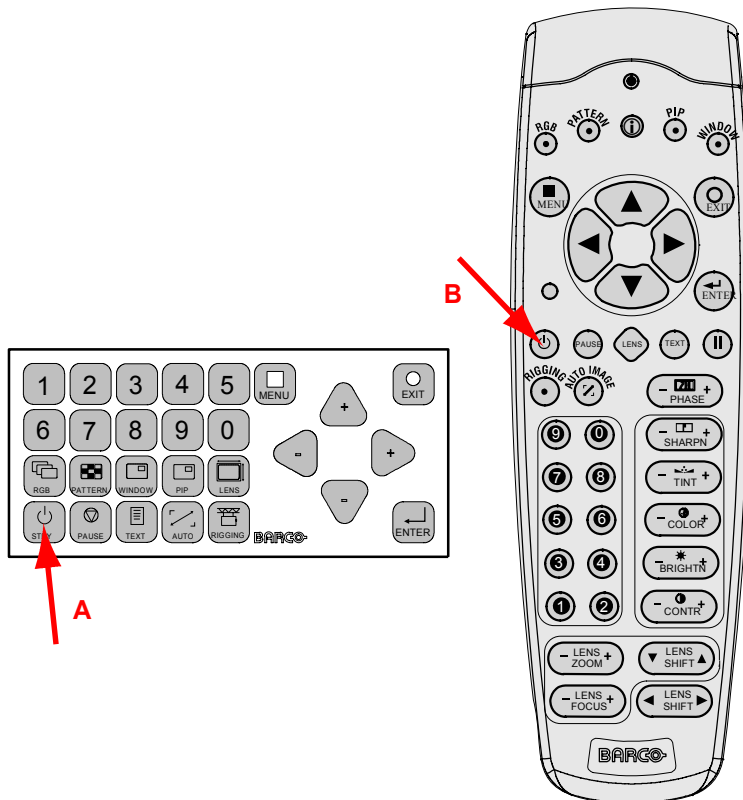

Image 6-3  
Stand by indication

- A Stand by indication on local keypad
- B Stand by indication on remote control

The projector status LED lights up.

The projector starts up on the last saved source.

Some lamp and runtime warnings can be displayed when an image is displayed after a start up.

### 6.3.2 Errors, warnings and messages during start up

#### Temperature error DMD

When the temperature of the DMD is too low or too high, the projector produces an error message.

When the DMD temperature is too low:

- Lower than 0°C, warning is displayed on the LCD panel and yellow warning LED is on. Both remains until the temperature is above 10°C.
- Between 0°C and 10°C, projector starts up normally with a warning on the LCD panel and the yellow warning LED lights up, but only for 10 minutes. When the temperature is then not above 10°C the projector goes in standby.

When the DMD temperature is too high:

- When temperature is between 60°C and 65°C, the lamp mode will be reduced from 4 lamps to 2 lamps or 1 lamp.
- When temperature is higher than 65°C, the projector switches to standby.

For a list of possible error codes, see "Error codes", page 205.

### 6.3.3 Switching to standby

#### How to switch to standby?

1. Press **Standby** to switch the projector to standby.

A cool-down counter (after cooling) starts counting down for 5 minutes (only visible on the local LCD panel). During this period the fans are still running.

A restart is possible during this period.



**Switching to Standby.** When the projector is running and you want to go to standby, press the standby key for 2 seconds. Do not press any longer on the standby key otherwise the projector will restart.



All custom settings are written to the internal backup device. A message 'Save data ...' indicates this process. Never switch off the projector while this message is displayed.



When pressing for at least 5 seconds on the Freeze button, the projector goes to standby without the risk of restart..

### 6.3.4 Switching off

#### How to switch off the projector?

1. Press first **Standby**.
2. Let cool down the projector until the fans decrease, at least 5 min.
3. Switch off the projector with the power switch.



**CAUTION:** Never switch off the projector while the message 'Save data ...' is displayed !

## 6.4 Using the RCU

### Pointing to the reflective screen

1. Point the front of the RCU to the reflective screen surface.

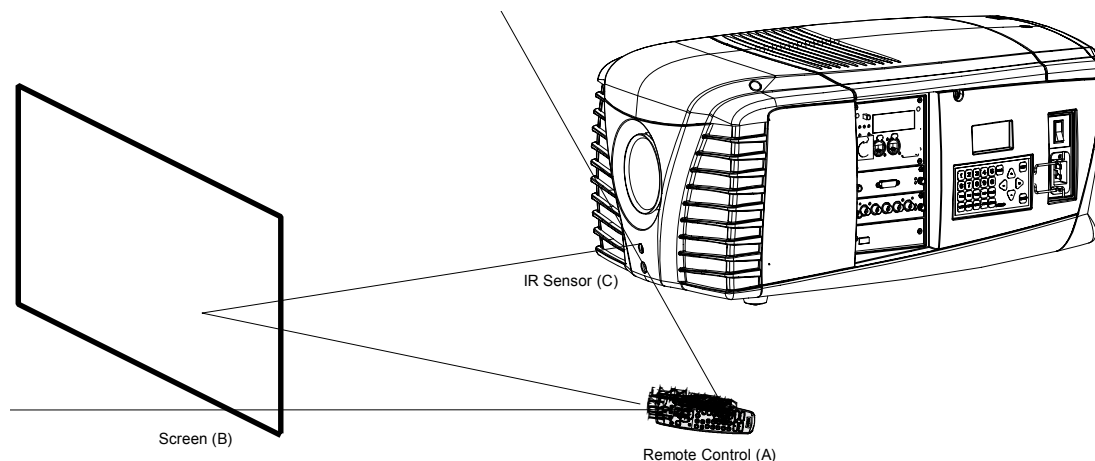

Image 6-4  
IR control via the reflective screen

### Hardwired to the XLR input

1. Plug one end of the remote cable in the connector on the bottom of the RCU
2. Plug the other end in the big connector in the input panel of the projector labelled **Remote CTRL in**.

### Directly to one of the IR sensors

When using the wireless remote control, make sure you are within the effective operating distance (30m, 100ft in a straight line). The remote control unit will not function properly if strong light strikes the sensor window or if there are obstacles between the remote control unit and the projector IR sensor.

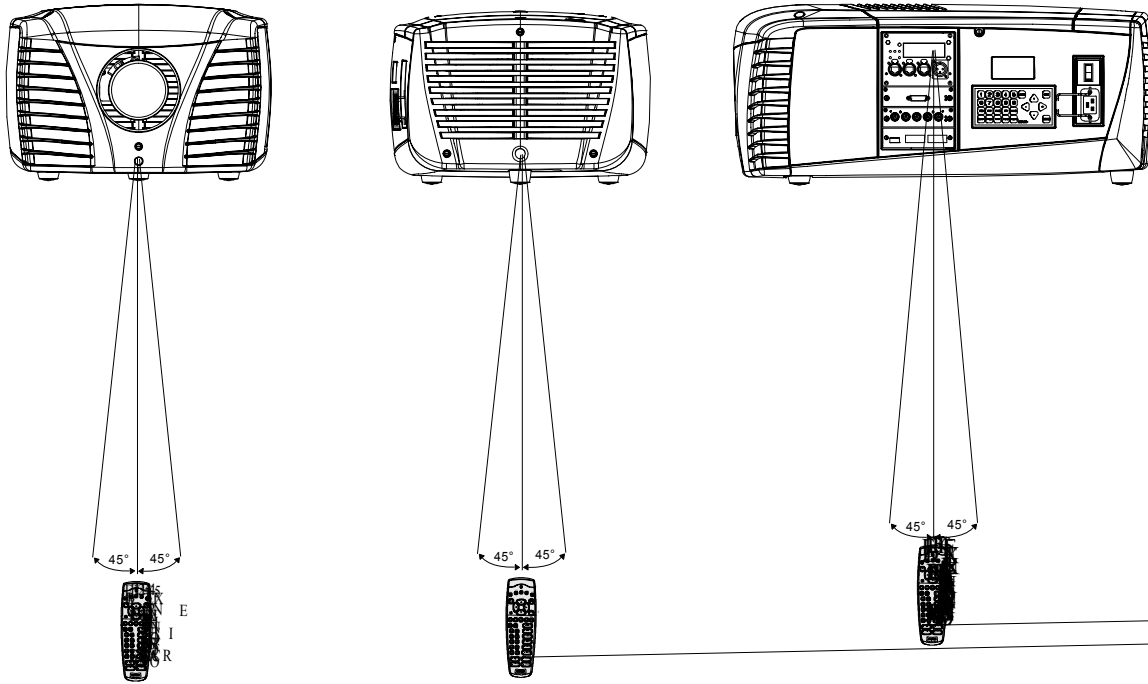

Image 6-5  
RCU to one of the IR sensors

## 6.5 Quick setup adjustments

### Overview

- Text boxes ON or OFF
- Quick Lens Adjustment
- Quick picture in picture
- Quick layout selection with Rigging key
- Quick language selection

### 6.5.1 Text boxes ON or OFF

#### Text toggle function

The on-screen text boxes can be switched OFF so that an adjustment during the operation of the projector are not visible on the screen. The adjustment indication remains visible on the local LCD screen.

To toggle Text ON or OFF, press the **TEXT** key on the remote control or local keypad.

### 6.5.2 Quick Lens Adjustment

#### 6.5.2.1 Quick Lens Adjustment via LENS key

##### Quick zoom/focus adjustment

1. Press the **LENS** key on the remote control or local keypad.

The zoom/focus menu will be displayed.

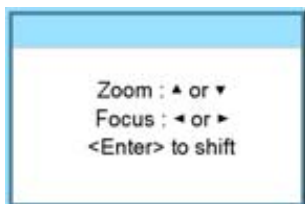

Image 6-6

2. Push the cursor key **▲** or **▼** to zoom and **◀** or **▶** to focus the image.

- When finished, press **EXIT** key to return or **ENTER** to continue to the shift adjustment.



Press the **LENS** key to switch to another pattern. Different patterns are available.

### Quick shift adjustment

- Press the **LENS** key on the remote control or local keypad.

The zoom/focus menu will be displayed.

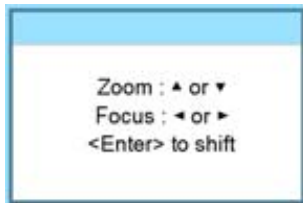

Image 6-7

- Press **ENTER**.

The shift menu will be displayed.



Image 6-8

- Push the cursor key **▲** or **▼** to shift the image up or down and **◀** or **▶** to shift the image left or right.
- When finished, press **EXIT** key to return or **ENTER** to continue to zoom/focus.



Press the **LENS** key to switch to another pattern. Different patterns are available.

## 6.5.2.2 Direct Lens Adjustment (RCU)

### Lens adjustment buttons on the Remote Control

On the Remote Control four buttons with double action are provided, allowing direct alignment for lens ZOOM, FOCUS, HORIZONTAL SHIFT and VERTICAL SHIFT.

- Press **LENS ZOOM** button [-] or [+] (A) for correct image size on the screen.

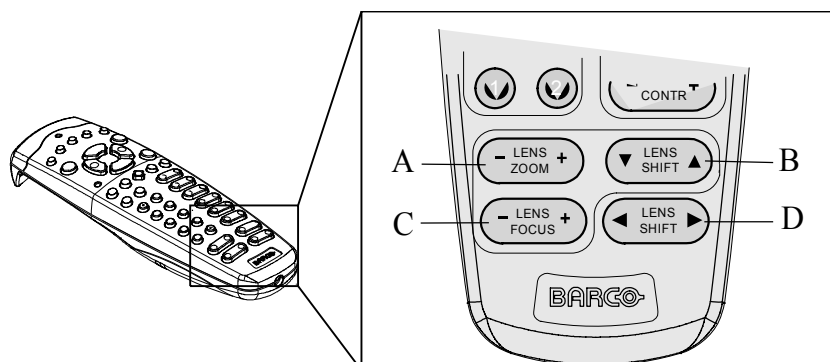

Image 6-9  
Direct lens adjustment keys

- A Zoom
- B Vertical shift
- C Focus
- D Horizontal shift

## 6. Getting started

---

2. Press **LENS FOCUS** button [-] or [+] (C) for an overall focus of the image.
3. Press **▲ LENS SHIFT ▼** button for correct vertical position of the image on the screen.
4. Press **◀ LENS SHIFT ▶** button for correct horizontal position of the image on the screen.

### 6.5.3 Quick picture in picture

#### Quick On - Off

Press on the **PIP** key on the remote control or the local keypad to activate the Load layout window.

Use the **▲ ▼** key to scroll to the desired layout and press **ENTER** to activate.



Select **Main full screen** to switch off PIP.

---



Image 6-10

### 6.5.4 Quick layout selection with Rigging key

#### What can be done ?

When the projector is playing, changing from one layout to another is possible without displaying any on screen selection menu. The current image is not disturbed as long no selection is made. Press the **Rigging** key followed by one or two digits to jump to a new layout.

When **Rigging** is pressed, an overview of the possible layouts with a sequence number is given on the local LCD panel. That sequence number is the number that should be pressed after Rigging is pressed to change the layout to the new selection.

#### How to make a selection

1. Press **Rigging** followed by one or two digits and wait.

**Note:** *If you press only one digit, the projector wait a few time to check if a second digit will follow. If not, it switches to the selected layout.*

The selected layout is loaded.

Or,

press **Rigging**.

The layout selection menu is displayed on the local LCD panel.

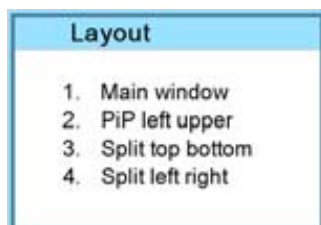

Image 6-11

2. Enter the digit or the two digits of your choice.

The selected layout is loaded.

Or,

scroll with the arrow keys to the desired layout and press **ENTER**.

The selected layout is loaded.



When no digit is pressed after Rigging is pressed, the layout selection menu disappears after a few seconds without a layout change.

## 6.5.5 Quick language selection

### Language selection

1. Press **Menu** to activate the menus and select with the ▲ or ▼ key Projector Control and press **ENTER**.
2. Select with the ▲ or ▼ key Language and press **ENTER**.  
The language menu opens.
3. Select with the ▲ or ▼ key the desired language and press **ENTER** to activate.  
The current active language is indicated with an asterisk (\*).

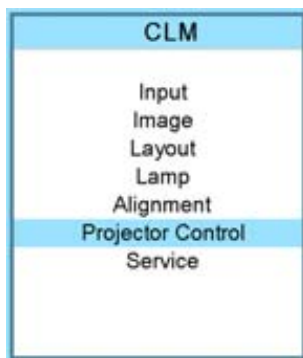

Image 6-12



Image 6-13



Image 6-14

## 6.6 Use of the AUTO button

### What is possible?

The AUTO button can be configured as an auto align of the projected source or as an auto image button which calls a choice menu. Within this choice menu, the user can execute an auto align of the image, an auto contrast/brightness and an auto phase.

To use this button, just press Auto on the remote control or the local key path.

When the button is configured as align only, the projected image will be aligned.

When the button is configured as auto image, the auto image menu will be displayed.

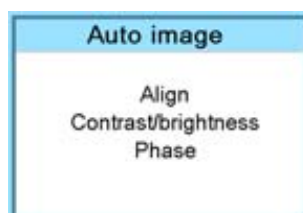

Image 6-15

Use the ▲ or ▼ key to select the desired function and press **ENTER** to activate.

## 6.7 Projector Address

### 6.7.1 Displaying and Programming addresses

#### Displaying the Projector Address on the Screen.

1. Press **Address** key (recessed key on the RCU) with a pencil.

## 6. Getting started

---

The projector's address is displayed as first item in the Identification screen.

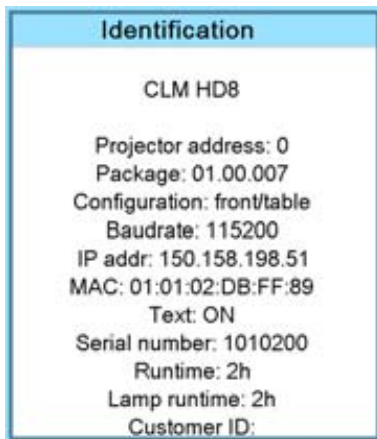

Image 6-16



To continue using the RCU with that specific address, it is necessary to enter the same address with the digit buttons (address between 0 and 9) within 5 seconds after pushing the address key. For example : if the Address key displays projector address 003, then press "3" digit button on the RCU to set the RCU's address to match the projector's address. Do not press 003 digits. This will address the remote control to '0' and control all projectors in the room. If the address is not entered within 5 seconds, the RCU returns to its default address (zero address) and control all projectors in the room.

### How to Program an Address into the RCU?

1. Press the **Address** key (recessed key on the RCU) with a pencil.
2. Enter the address with the digit buttons within 5 seconds after pushing the address key.  
**Note:** That address can be any digit between 0 and 9.



The LED on the remote control must lit up while pressing a digit key. Otherwise the address is not entered in the remote control.

### 6.7.2 Controlling the projector



#### Projector address

Address installed in the projector to be individually controlled.



#### Common address

Projector will always execute the command coming from a RCU programmed with that common address.

### Why a projector address ?

As more than one projector can be installed in a room, each projector should be separately addressable with an RCU or computer. Therefore each projector has its own address.

### Set up an individual Projector Address.

The set up of a projector address can be done via the software. See chapter 'Projector Control', 'Projector address'.

### Projector controlling.

Every projector requires an individual address between 0 and 255 which can be set in the Service mode.

When the address is set, the projector can be controlled now:

- RCU for addresses between 0 and 9.
- computer, e.g. IBM PC (or compatible), Apple MAC, etc. for addresses between 0 and 255.



## Common Address

Every projector has a common address '0' or '1'. The choice between '0' and '1' can be selected in *Projector Control* → *Projector address* → *Common address*.

## 6.8 Source selection

### Source selection when no picture in picture is active

Use the digit keys on the remote control or local keypad to activate the desired source.

### Source selection when picture in picture is active

Use the **Window** button on the remote control or the local keypad to select the main window or the picture in picture (PiP) window.

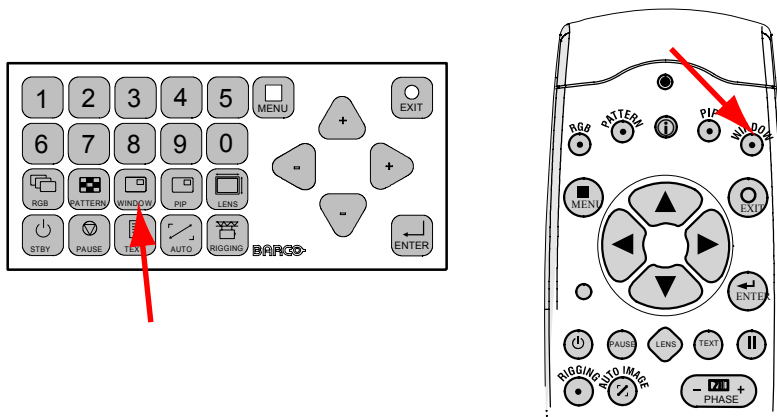

Image 6-17  
Window selection button

The outline of the selected window gets a colored rectangle to indicate the selection. For the main window, the color is blue. For the picture in picture window, the color is orange.

Once the desired window is activated (main window or picture in picture window) all keys on the remote control or local keypad can now control that selected window.

To select the source for the picture in picture window, press Window button until PiP window is activated and then select the desired source with the digit keys.

To select the source for the main window, press Window button until the main window is activated and then select the desired source with the digit keys.

## 6.9 Controlling the Projector

### Picture Controls

When an image control is pressed, a text box with a bar scale, icon and function name of the control, e.g. 'brightness...' appears on the screen (only if text is ON). See example screen. The length of the bar scale and the value of the numeric indication indicate the current memorized setting for this source. The bar scale changes as the control buttons on the RCU are pressed.

Brightness	A correct 'brightness' setting is important for good image reproduction. Use the + button for a higher brightness. Use the - button for a lower brightness.
Contrast	A correct 'contrast' setting is important for good image reproduction. Adjust the contrast to the level you prefer, according to room lighting conditions. Use the + button for a higher contrast. Use the - button for lower contrast.
Color	Color saturation is only active for all type of video sources, such as Video, S-Video, SDI, HDSDI. Adjust the color intensity of the picture. Use the + button for richer colors. Use the - button for lighter colors.

Tint	Tint is only active for Video and S-Video when using the NTSC 4.43 or NTSC 3.58 system. Use the + button for more tint Use the - button for less tint.
Sharpness	The sharpness function is used to adjust the image sharpness of video signals. Use the + button for more sharpness Use the - button for less sharpness
Phase	Use the + or - side of the phase control button to adjust the phase.

### The Pause Key

When the Pause key is pressed, the image projection is stopped, a black screen will be displayed and the projector remains with full power for immediate restart. The 7-segment display on the projector will show a "P". The shutter is closed.

To restart the image, press one of the following keys:

- Press **Pause** key.
- Select a source number.

### The Stand-by Key

When the Stand-by key is pressed, the image projection is stopped and the projector goes to stand-by. This situation is used when a projection stop is planned for a longer period. All custom settings are saved to an internal backup device. A message 'Save data ...' is displayed during this backup operation.

### The Freeze key

When pressing for 5 seconds on the Freeze button, the projector goes to stand-by. This function is very useful when multiple projectors have to be switched to stand-by. Set the RCU address to the common address and press Freeze for 5 seconds. All projectors go to stand-by without the risk of restart.

When pressing shortly on Freeze, the current image is frozen.

## 7. START UP OF THE ADJUSTMENT MODE

### Overview

- About the adjustment mode
- About the use of the remote control and the local keypad
- Start up the adjustment mode
- Navigation and adjustments
- On screen menus versus LCD display menus

### 7.1 About the adjustment mode

---

#### Overview

As the adjustment mode is the central place to control and align the projector, the following functions can be done:

- Input setup: the different inputs can be configured for a specific format or input source.
- Image adjustment: these adjustments are organized per image source and contain the aspect ratio, timings and image settings.
- Layout adjustment: set up of the main window and the picture in picture window.
- Lamp: manage the lamp mode, the lamp use, lamp type and history
- Alignment: groups all controls necessary during the setup of the projector onto a screen.
- Projector control: contains the accessibility settings of the projector, such as address and communication setup.
- Service: contains information about how the projector is performing. This information will be useful when calling for a service intervention.

### 7.2 About the use of the remote control and the local keypad

---

#### Overview

All navigations and adjustments can be done either with the remote control or with the local keypad.

Almost all the keys on the remote control have an equivalent on the local keypad.

Exceptions:

- ▲ on the remote control corresponds with the up + key on the local keypad.
- ▼ on the remote control corresponds with the down - key on the local keypad.
- ◀ on the remote control corresponds with the left - key on the local keypad
- ▶ on the remote control corresponds with the right + key on the local keypad

### 7.3 Start up the adjustment mode

---

#### Start up tools

To start up the adjustment mode, use the remote control or the local keypad.

#### How to start up?

1. Press **Menu** on the remote control (RCU) or on the local keypad to start up the *Adjustment* mode.

## 7. Start up of the adjustment mode

---

The main menu of the adjustment mode opens.



Image 7-1

## 7.4 Navigation and adjustments

---

### How to navigate in the menu structure?

Once in the menu structure, use the **▲** or **▼** keys on the remote control (or the **▲** or **▼** (+ or -) key on the local keypad) to scroll through the items in the displayed menu. The selected item will get a background color. To activate a selected submenu or function, press **ENTER**.

When on a submenu, to return one step to the parent menu, press **EXIT**.

To escape the menu structure when on a menu, press **MENU**.

### How to make an adjustment?

With the remote control, press the **▲** or **▼** keys until the desired value (setup) is reached. Press **EXIT** to finalize the adjustment.

With the local keypad, press the **▲** or **▼** (+ or -) keys until the desired value (setup) is reached. Press **EXIT** to finalize the adjustment.

All adjustments will be indicated with an on-screen box with the name of the adjustment in the title bar, the length of the progress bar indicates the actual value. The value at the start and at the end of the progress bar indicates the adjustment ranges.

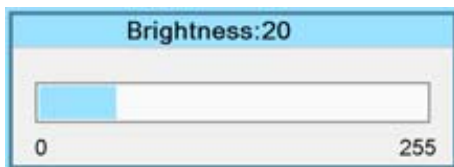

Image 7-2

While a bar scale is displayed, it is also possible to enter the desired value directly with the digit keys. Therefore, press **ENTER**. The menu changes to a *Enter new value* menu with the current value filled out. The first digit is selected.

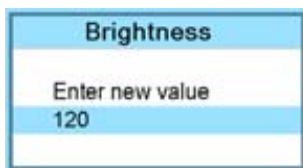

Image 7-3

Use the **◀** or **▶** key to jump to the next digit or enter a new value for the selected digit with the digit keys and then the selection will jump also to the next digit. Repeat this action for all other digits and press **ENTER** to finalize the input.

If applicable in direct input, toggle between + and - with the left arrow key (**◀**).

## 7.5 On screen menus versus LCD display menus

---

### Overview

As the projector is equipped with an 8 lines LCD panel, the on-screen menus are also displayed on that LCD panel in the same structure as the on screen menus. These menus can be used in the same way as the on-screen menus.

The menus on the LCD panel are still reachable even when the projector lamp is not activated and when Text is in the off mode.

When quitting the menu structure, the backlighting of the LCD panel is switched off after a few seconds.



## 8. INPUT MENU

### Overview

- Overview flow
- Slot module type
- Input locking
- Minimum delay
- Native resolution
- Source switching
- No signal

### 8.1 Overview flow

#### Overview

Level 1	Level 2	Level 3
Input		
	Slot module type	5-cable HD-SDI - SDI DVI DVI HDCP
	Input locking	Freerun Automatic Input 1 to 2
	Minimum delay [On/Off]	
	Native resolution [On/Off]	
	Source switching	Effect Transition time
	No signal	Color [black/blue] Shutdown [Off/On] Shutdown time

### 8.2 Slot module type

#### Overview

- About Input Setup
- Input configuration

#### 8.2.1 About Input Setup

##### Overview

Each input module must be configured before these module can be used. This configuration is necessary so that the projector knows which type of signal is connected to its input.

The projector has 2 input slots and these slots can be filled up in a random order with the available modules. Identical modules are allowed.

For more information about the available input modules and how to install, see "Input source connections", page 37.



**CAUTION:** Always install a cover plate on an unused input slot. This to prevent dust intrusion into the projector.

### 8.2.2 Input configuration

#### How to change?

1. Press **MENU** to activate the menus.
2. Use the **▲** or **▼** key to select *Input* and press **ENTER**.  
The Input menu is displayed.
3. Use the **▲** or **▼** key to select *Slot module type* and press **ENTER**.  
The slot overview window is displayed with the actual situation filled out.
4. Use the **▲** or **▼** key to select a slot.  
Press **ENTER** to open the Slot module type configuration window. This window is different for each module type.
5. Use the **▲** or **▼** key to select desired mode for the selected slot.

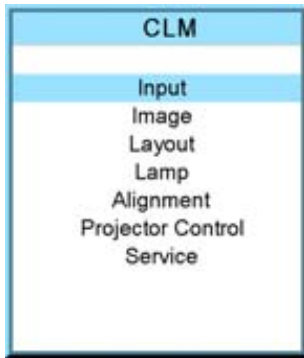

Image 8-1

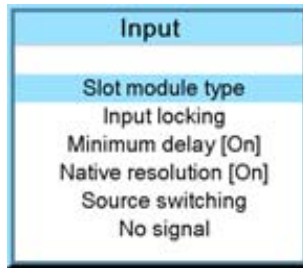

Image 8-2

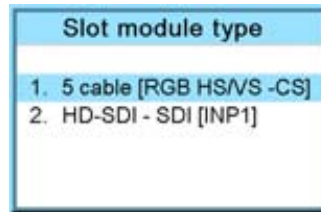

Image 8-3



Image 8-4

#### Possible results.

Input module	Indication	Description
5 cable	RGB AUTO	RGB input. Projector searches for the sync signal and projects the correct image.
	YUV AUTO	YUV input. Projector searches for the sync signal and projects the correct image.
	CVS/S-VIDEO AUTO	Video or S-Video input. Projector detects automatically which type of video is connected to the inputs.
	RGB HS/VS - CS	RGB input with separate horizontal and vertical sync or separate composite sync.



Input module	Indication	Description
	RGB CV	RGB input with composite video as sync signal
	RGB SOG	RGB input with sync on green
	YUV HS/VS - CS	Component video with separate horizontal and vertical sync or separate composite sync.
	YUV CV	Component video with composite video as sync signal
	YUV SOY	Component video with sync on Y
	CVBS	Composite video
	S-Video	Super video
HD-SDI - SDI	INP 1 PRIORITY	When signal on both inputs, input 1 has the priority.
	INP 2 PRIORITY	When signal on both inputs, input 2 has the priority.
	INP1	Input 1 selected
	INP2	Input 2 selected
DVI HDCP	DVI HDCP	High definition content protected DVI input

### DVI equalization

When a standard DVI module is selected, press **ENTER** to go in edit mode. Use ◀ or ▶ to key to change the equalization value.

Default value = 13.

For non DVI-compliant transmitter, stronger equalization may be necessary even for shorter cables.

For longer cables adjust between 0 and 13 (more equalization).

For shorter cables adjust between 13 and 15 (least equalization).

### Advanced settings for 5 cable input

For RGB with separate sync or YUV with separate sync the sync level can be toggled between *Analog* or *Digital*.

Use the ▲ or ▼ key to select *Advanced settings*. The *5 cable advanced* box opens.

Press **ENTER** to toggle between *Analog* or *Digital*.

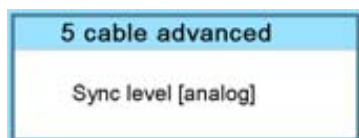

Image 8-5

## 8.3 Input locking

### What is possible?

The output signal can be locked on an internal sync signal or on the sync signal of one of the input sources. Input locking can avoid that some windows in the output signal are slowly moving or trembling.

When automatic is selected, the lock will be set on the input signal of the main window.

### How to set up?

1. Press **MENU** to activate the menus.
2. Use the ▲ or ▼ key to select *Input* and press **ENTER**.  
The Input menu is displayed.
3. Use the ▲ or ▼ key to select *Input locking* and press **ENTER**.  
The input locking window is displayed. The actual selected locking method is indicated by an arrow.
4. Use the ▲ or ▼ key to select the desired locking and press **ENTER**.

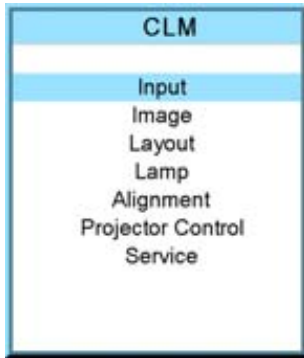

Image 8-6

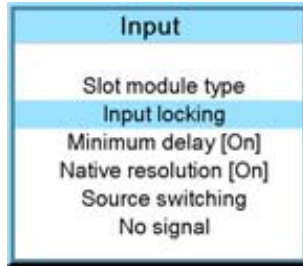

Image 8-7



Image 8-8

When:

Free run	Output is locked on an internal sync (60 Hz)
Automatic	Output is locked on the selected input for the main window
Input 1	Output is locked on source 1
Input 2	Output is locked on source 2

The options menu changes depending on the selection.



When Input locking is set to Automatic or on a specific input and there is no sync signal available, the locking will be switched to Free run without changing the user settings. Once the sync is available, it applies again the user settings.

### Options for Free run

When *Free run* is selected (arrow in front of it) and then the *Options* are selected, the following menu appears:

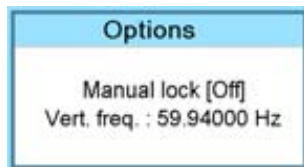

Image 8-9

Use the ▲ or ▼ key to select *Manual lock* and press **ENTER** to toggle between *On* and *Off*.

Manual lock on : locking is done on the indicated vertical frequency which can be changed by the user.

Manual lock off : locking is done on an internal sync (60 Hz).

To change the locking frequency for manual lock on, use the ▲ or ▼ key to select *Vert freq* and press **ENTER** to activate. The first digit is selected.

Use the ▲ or ▼ key to select the desired digit and press ◀ or ▶ key to select the next digit in the address or enter the value with the digit keys on the remote control or local keypad. The next digit in the value will be automatically selected.

### Options for Automatic or specific input

When *Automatic* or specific input is selected (arrow in front of it) and then the *Options* are selected, the following menu appears:

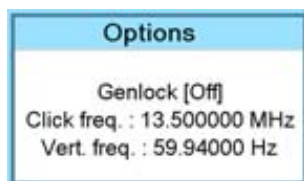

Image 8-10

Use the ▲ or ▼ key to select *Genlock* and press **ENTER** to toggle between *On* and *Off*.

- Genlock off (default position) locking done on input source of main window, when automatic was selected or on the selected input source when a specific input was selected. Projector detects automatically the vertical frequency and clock frequency of the input signal. A slightly difference with the source is possible.
- Genlock on locking done on indicated vertical frequency and clock frequency. This vertical frequency and clock frequency must be exactly the same as those of the source.
- Only use genlock ON for very stable sources and preferable for broadcast sources.

For Genlock on,

to change the locking frequency, use the ▲ or ▼ key to select *Vert freq* and press **ENTER** to activate. The first digit is selected.

Use the ▲ or ▼ key to select the desired digit and press ◀ or ▶ key to select the next digit in the address or enter the value with the digit keys on the remote control or local keypad. The next digit in the value will be automatically selected.

to change the clock frequency, use the ▲ or ▼ key to select *Clock freq* and press **ENTER** to activate. The first digit is selected.

Use the ▲ or ▼ key to select the desired digit and press ◀ or ▶ key to select the next digit in the address or enter the value with the digit keys on the remote control or local keypad. The next digit in the value will be automatically selected.



**For older custom files, created with software packages older than package 1.5.6, the Genlock function will be grayed out. If you want to use this genlock function, a new custom file must be created starting from the standard file. Copying the custom file in a new file do not solve this issue.**

## 8.4 Minimum delay

### Purpose

In normal mode, the processing (scaling and de-interlacing) in DLP projectors introduces a few frames delay (from input to screen). Setting the option *Minimum Delay* to "ON" disables all scaling and de-interlacing in the processing and reduces frame delay of the projector (from input to screen) to ONE frame, caused by the formatter board (DLP technology restriction). The intended use of this option is to apply native and progressive data to the projector and displaying it with minimum delay, using the full resolution of the projector. Other formats will be displayed either unscaled and/or interlaced.

This feature can be used if additional delay in the projector is not acceptable. For instance if a projector is showing the DVI loop out of another DLP or if an external scaler/de-interlacer does the processing.

### How to toggle the delay?

1. Press **MENU** to activate the menus.
2. Use the ▲ or ▼ key to select *Input* and press **ENTER**.  
The Input menu is displayed.
3. Use the ▲ or ▼ key to select *Minimum delay* and press **ENTER** to toggle between [On] and [Off].

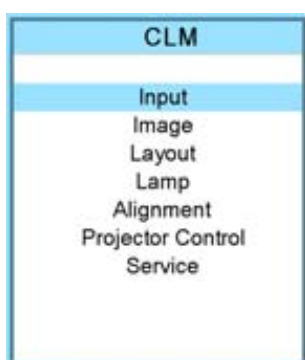

Image 8-11

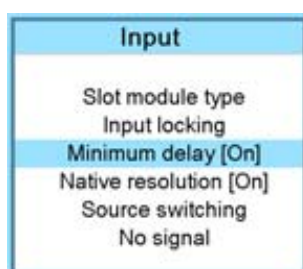

Image 8-12

## 8.5 Native resolution

### What can be done

The aim here is to always show the resolution of the source independently of the resolution of the DMD panels.

8. Input menu

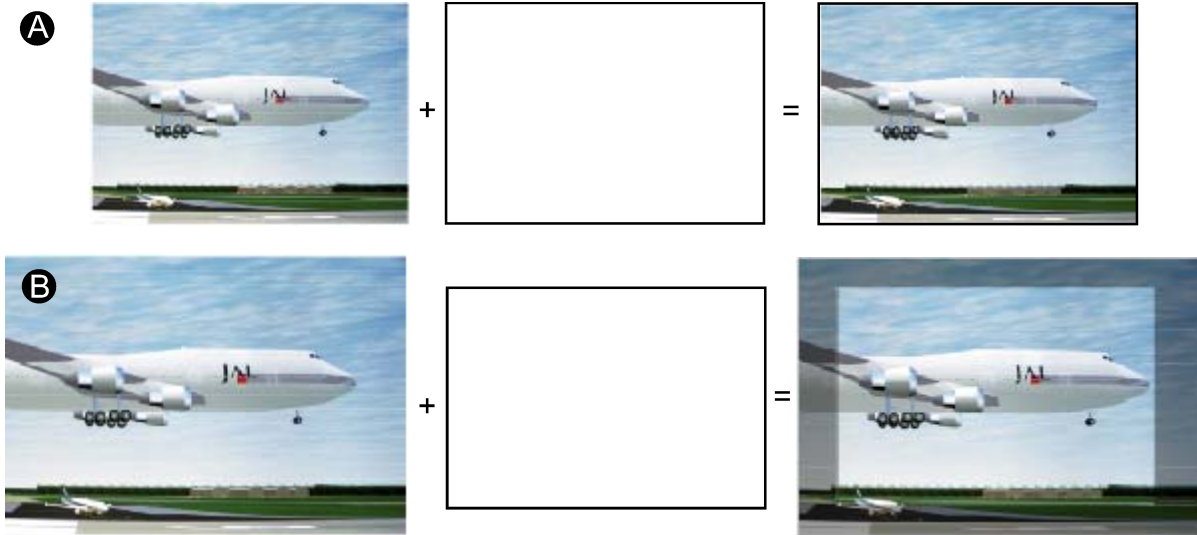

Image 8-13

When the *show native resolution* function is in the ON position, the projector handles the source as follows:

Source			Projected image		
Name	Ratio	Resolution	Ratio	Resolution	
XGA	4:3	1024x768	4:3	1024x768	image projected with black borders
SXGA	5:4	1280x1024	5:4	1280x1024	image projected with black borders
SXGA+	4:3	1400x1050	4:3	1400x1050	image projected with black borders
UXGA	4:3	1600x1200	4:3	1600x1200	part of the image displayed, image scroll possible Black borders left and right.
	16:9	1920x1080	16:9	1920x1080	normal image projected

**How to toggle to native resolution?**

1. Press **MENU** to activate the menus.
2. Use the **▲** or **▼** key to select *Input* and press **ENTER**.  
The Input menu is displayed.
3. Use the **▲** or **▼** key to select *Native resolution* and press **ENTER** to toggle between [On] and [Off].  
[On] : images displayed in native resolution  
[Off] : images scaled to fill the complete screen

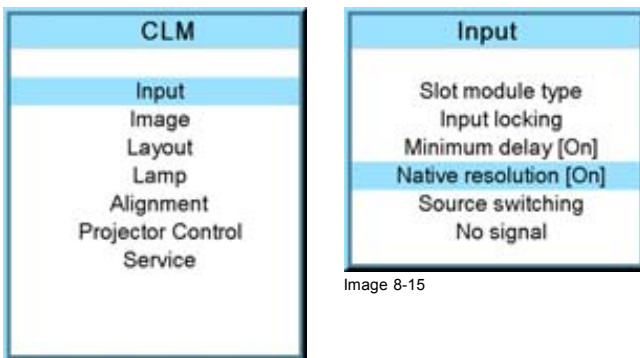

Image 8-15

Image 8-14



When native resolution is on, some other menus such as *Aspect ratio*, *timings* are greyed out.

## 8.6 Source switching

### Switching from one source to another

To minimize undesired effects when switching from one source to another one can use the switching mode, using the fade effect.



Image 8-16  
Example of fade effect

### Switching mode set up

1. Press **MENU** to activate the menus.
2. Use the **▲** or **▼** key to select *Input* and press **ENTER**.  
The Input menu is displayed.
3. Use the **▲** or **▼** key to select *Source switching* and press **ENTER**.  
The Source switching menu is displayed.
4. Use the **▲** or **▼** key to select *Effect* and press **ENTER** to toggle between *No transition* and *Fade*.  

No transition	No source switching effect is activated.
Fade	Fade in, fade out effect is activated. Transition time can be set up.
5. Use the **▲** or **▼** key to select *Effect time* and press **ENTER**.
6. Enter the desired time with the digit keys  
Or,  
use the **▲** or **▼** key to scroll until the desired time is reached. Press **ENTER** to activate.

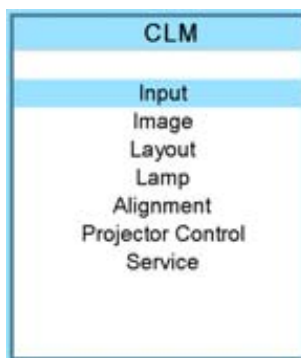

Image 8-17

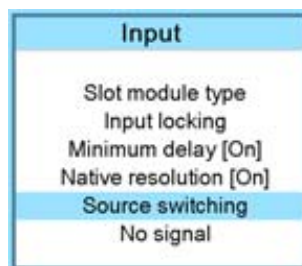

Image 8-18

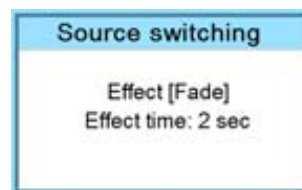

Image 8-19

## 8.7 No signal

### Overview

- Background color
- Shutdown setting
- Shutdown retarding time

### What can happen when no signal

When no signal available, a blue or black background color can be displayed or the projector can be shutdown with a certain retarding time.

#### 8.7.1 Background color

##### How to change the color

1. Press **MENU** to activate the menus.
2. Use the **▲** or **▼** key to select *Input* and press **ENTER**.  
The Input menu is displayed.
3. Use the **▲** or **▼** key to select *No signal* and press **ENTER** to toggle between [Black] and [Blue].

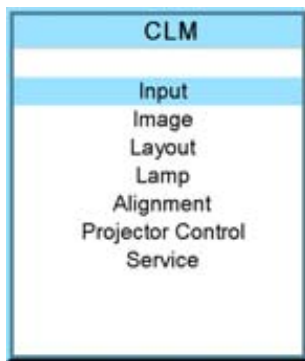

Image 8-20

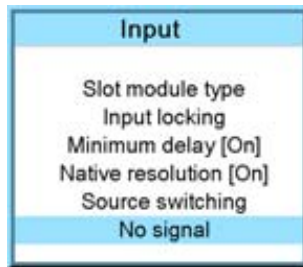

Image 8-21

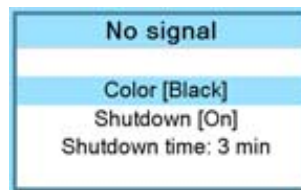

Image 8-22

#### 8.7.2 Shutdown setting

##### How to change the shutdown setting

1. Press **MENU** to activate the menus.
2. Use the **▲** or **▼** key to select *Input* and press **ENTER**.  
The Input menu is displayed.
3. Use the **▲** or **▼** key to select *Shutdown* and press **ENTER** to toggle between [On] and [Off].

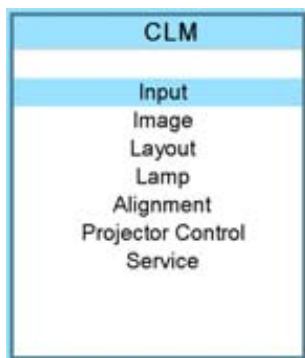

Image 8-23

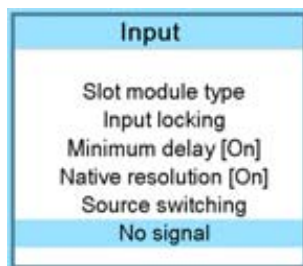

Image 8-24



Image 8-25

#### 8.7.3 Shutdown retarding time



Only accessible when *Shutdown* is set to [On].

##### How to set the retarding time?

1. Press **MENU** to activate the menus.
2. Use the **▲** or **▼** key to select *Input* and press **ENTER**.

The Input menu is displayed.

- Use the ▲ or ▼ key to select *Shutdown time* and press **ENTER**.
- Use the ▲ or ▼ key to change the value.  
Or,  
enter the desired value with the keyboard.

When trying to exceed the maximum allowed value, the system will set it back to the maximum value.

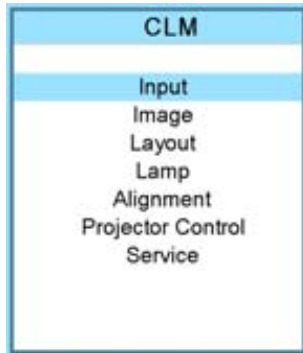

Image 8-26

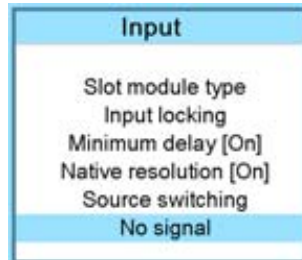

Image 8-27



Image 8-28





## 9. IMAGE MENU

### Overview

- Overview flow
- How to select the image adjustments?
- Image Settings
- Aspect ratio
- Timings
- Image files services
- Save custom settings

### 9.1 Overview flow

#### Overview

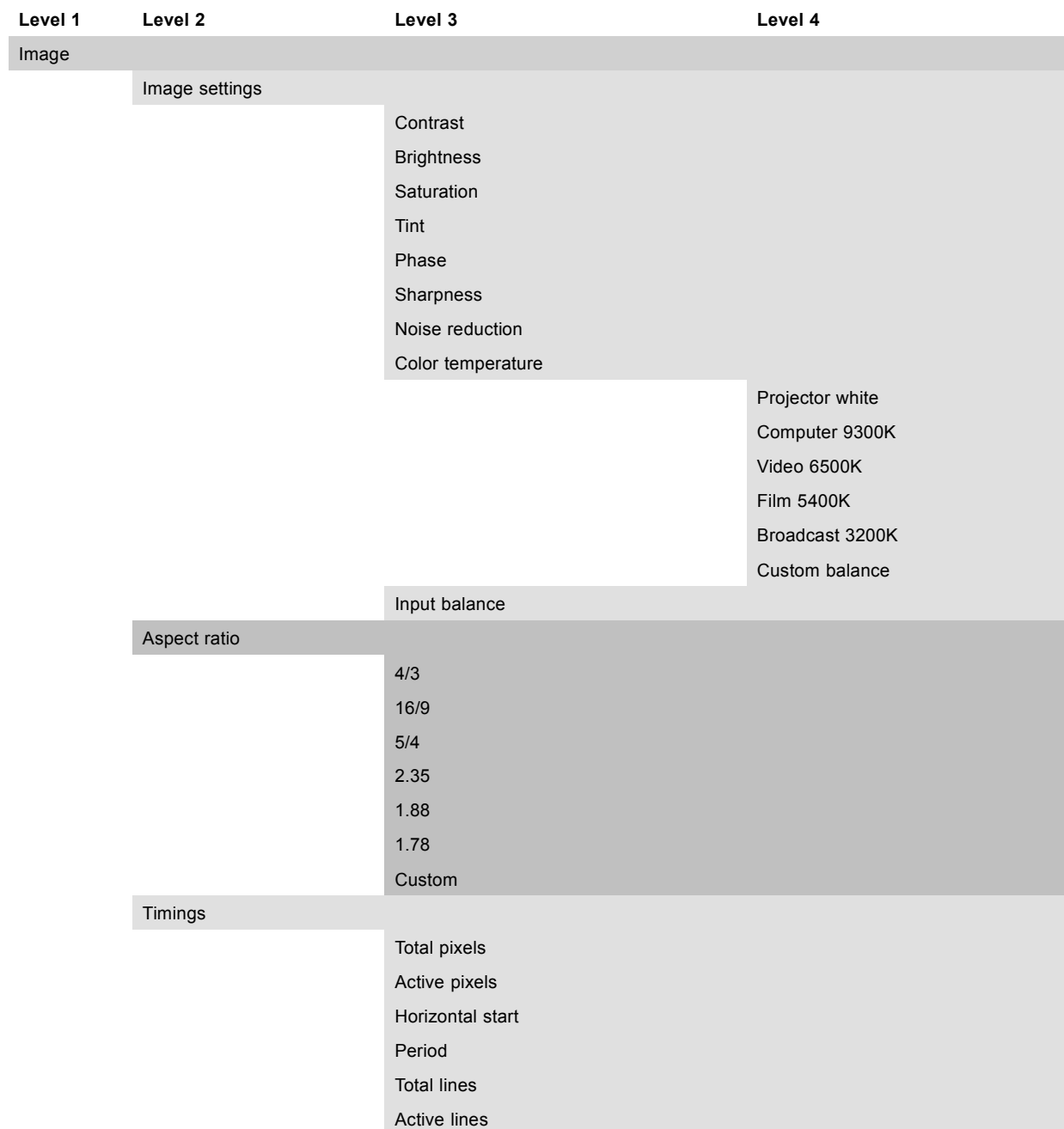

## 9. Image menu

---

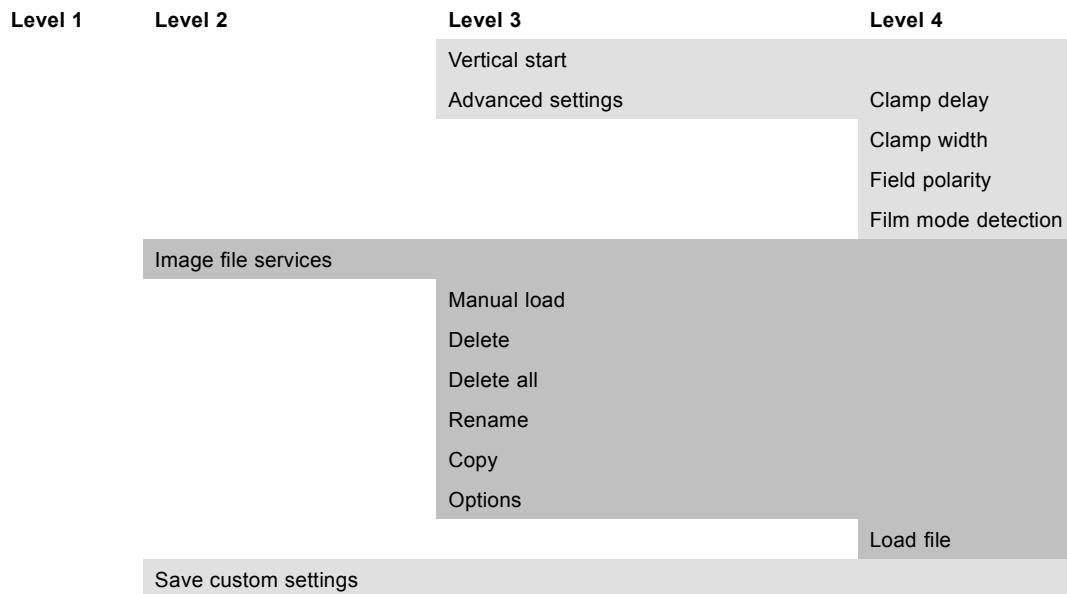

## 9.2 How to select the image adjustments?

---

### Start up

1. Use the ▲ or ▼ key to select *Image*.
2. Press **ENTER** to select.

The *Image* menu opens.

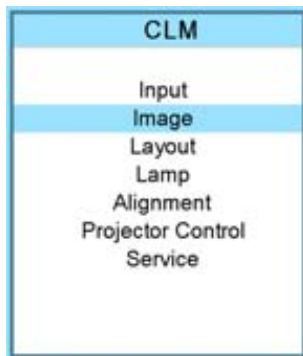

Image 9-1



Image 9-2

## 9.3 Image Settings

---

### Overview

- Contrast
- Brightness
- Saturation
- Tint (hue)
- Phase
- Sharpness
- Noise reduction
- Color temperature
- Input balance

### 9.3.1 Contrast

#### About Contrast

The contrast function is used to adjust the contrast between the light and dark areas of the displayed image.

#### How to change the contrast?

1. Press **MENU** to activate the menus.
2. Use the **▲** or **▼** key to select *Image* and press **ENTER**.
3. Use the **▲** or **▼** key to select *Image settings* and press **ENTER**.
4. Use the **▲** or **▼** key to select *Contrast* and press **ENTER**.

The Contrast progress bar appears.

5. Use **◀** or **▶** to change the contrast.

The higher the value, the higher the contrast.

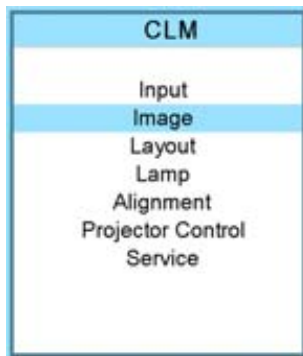

Image 9-3



Image 9-4

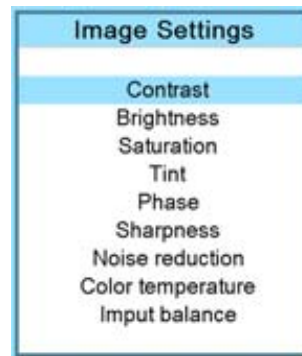

Image 9-5

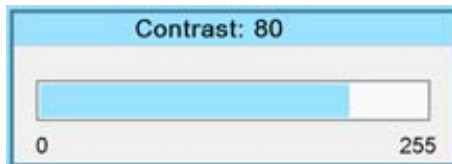

Image 9-6

### 9.3.2 Brightness

#### About Brightness

The Brightness function is used to adjust the overall light output.

#### How to change the brightness?

1. Press **MENU** to activate the menus.
2. Use the **▲** or **▼** key to select *Image* and press **ENTER**.
3. Use the **▲** or **▼** key to select *Image settings* and press **ENTER**.
4. Use the **▲** or **▼** key to select *Brightness* and press **ENTER**.

The Brightness progress bar appears.

5. Use **◀** or **▶** to change the brightness.

## 9. Image menu

The higher the value, the higher the brightness.

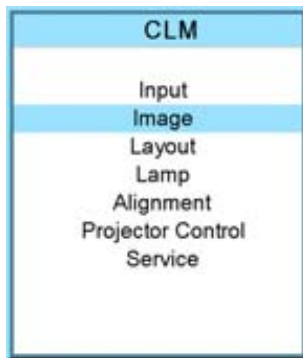

Image 9-7



Image 9-8

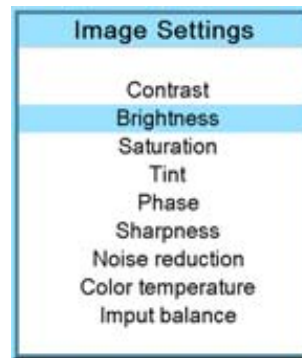

Image 9-9

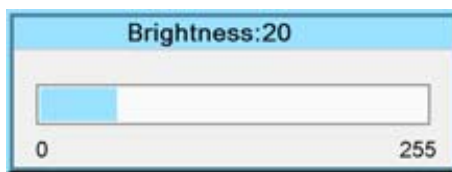

Image 9-10

### 9.3.3 Saturation

#### About (color) saturation

The color function is used to adjust the color saturation levels.

#### How to change the saturation?

1. Press **MENU** to activate the menus.
2. Use the **▲** or **▼** key to select *Image* and press **ENTER**.
3. Use the **▲** or **▼** key to select *Image settings* and press **ENTER**.
4. Use the **▲** or **▼** key to select *Saturation* and press **ENTER**.

The Saturation progress bar appears.

5. Use **◀** or **▶** to change the color saturation.

The higher the value, the higher the color saturation.

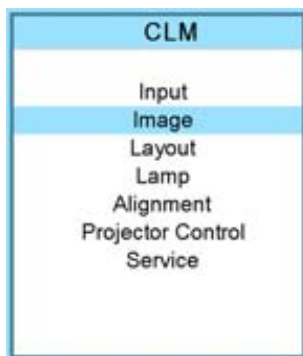

Image 9-11



Image 9-12

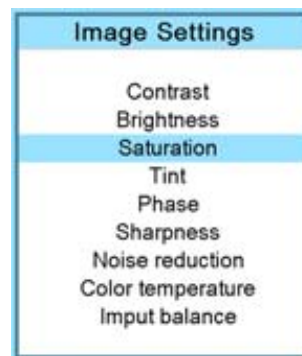

Image 9-13

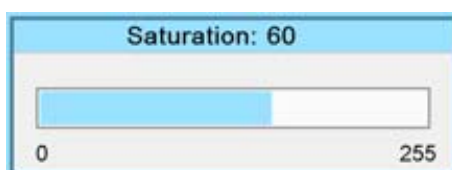

Image 9-14

### 9.3.4 Tint (hue)

#### About Tint

The Tint function is used to adjust color hue to obtain true color reproduction and is only active for Video and S-Video when the NTSC color system is used. For PAL and SECAM sources, Tint is not accessible.

#### How to change the saturation?

1. Press **MENU** to activate the menus.
2. Use the **▲** or **▼** key to select *Image* and press **ENTER**.
3. Use the **▲** or **▼** key to select *Image settings* and press **ENTER**.
4. Use the **▲** or **▼** key to select *Tint* and press **ENTER**.

The Tint progress bar appears.

5. Use **◀** or **▶** to change the tint.

The higher the value, the higher the tint.

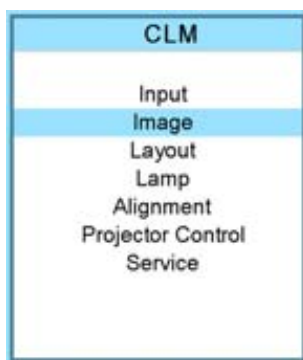

Image 9-15



Image 9-16

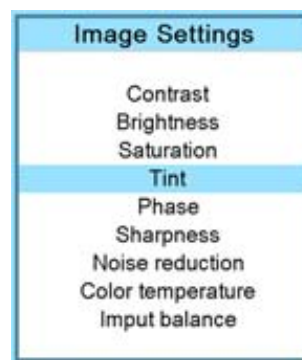

Image 9-17

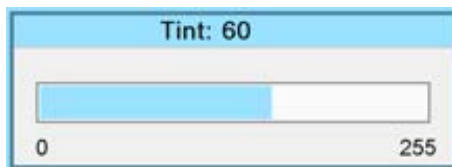
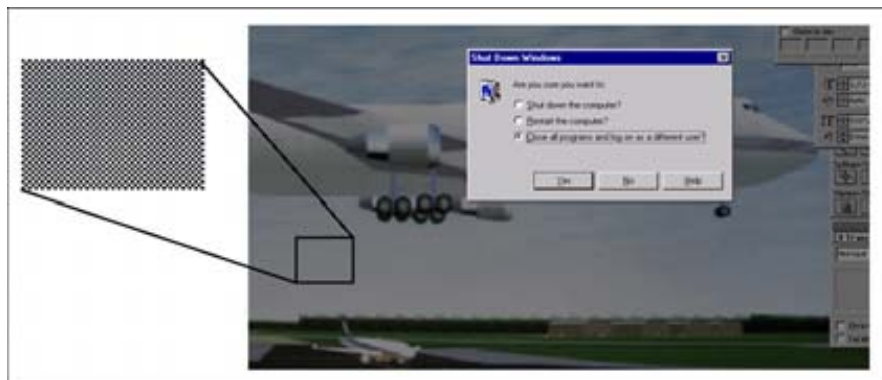

Image 9-18

### 9.3.5 Phase

#### About Phase adjustment

When displaying computer patterns or graphics (RGB or YUV signals) which are very detailed (tilting, vertical stripes, etc. ), jitter in picture (mis-sampling) may occur, causing horizontal stripes in portions of the screen. When this jitter occurs, adjust 'Phase' for optimum image.

Image 9-19  
Jittering on image

### How to change the phase?

1. Press **MENU** to activate the menus.
2. Use the **▲** or **▼** key to select *Image* and press **ENTER**.
3. Use the **▲** or **▼** key to select *Image settings* and press **ENTER**.
4. Use the **▲** or **▼** key to select *Phase* and press **ENTER**.

The Phase progress bar appears.

5. Use **◀** or **▶** to change the phase and refine the jitter.

**Note:** Don't mix up with wrong number of total pixels. If the jitter doesn't disappear with the phase adjustment, check the total number of pixels. (Best image = pixel on pixel off pattern. For example: shut down screen of a PC)

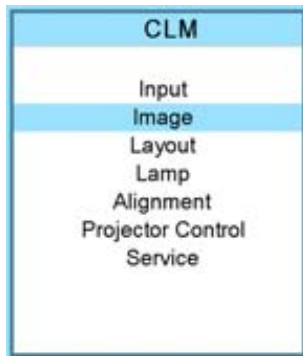

Image 9-20



Image 9-21

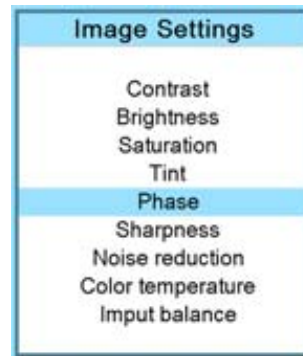

Image 9-22

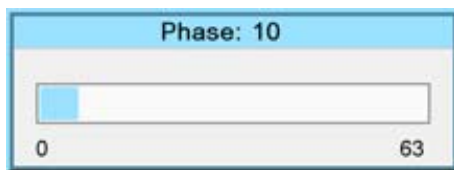

Image 9-23

### 9.3.6 Sharpness

#### About Sharpness

The sharpness function is used to adjust the image sharpness of video signals.

#### How to change the sharpness?

1. Press **MENU** to activate the menus.
2. Use the **▲** or **▼** key to select *Image* and press **ENTER**.
3. Use the **▲** or **▼** key to select *Image settings* and press **ENTER**.
4. Use the **▲** or **▼** key to select *Sharpness* and press **ENTER**.

The Sharpness progress bar appears.

5. Use **◀** or **▶** to change the sharpness.

The higher the value, the higher the sharpness.

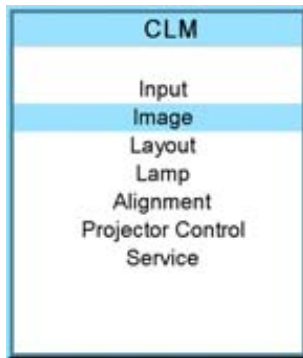

Image 9-24



Image 9-25

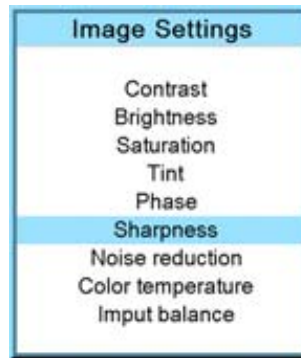

Image 9-26

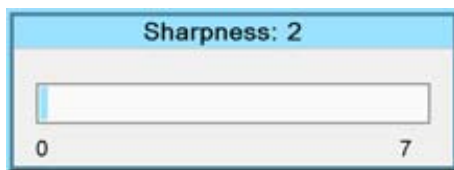

Image 9-27

### 9.3.7 Noise reduction

#### About Noise reduction

Reduces noise and pixel jitter in all video sources.

#### How to change?

1. Press **MENU** to activate the menus.
2. Use the **▲** or **▼** key to select *Image* and press **ENTER**.
3. Use the **▲** or **▼** key to select *Image settings* and press **ENTER**.
4. Use the **▲** or **▼** key to select *Noise reduction* and press **ENTER**.

The Noise reduction progress bar appears.

5. Use **◀** or **▶** to change the noise reduction.

The higher the value, the higher the noise reduction.

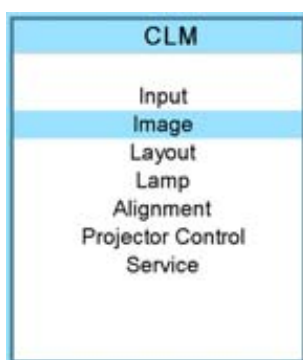

Image 9-28



Image 9-29

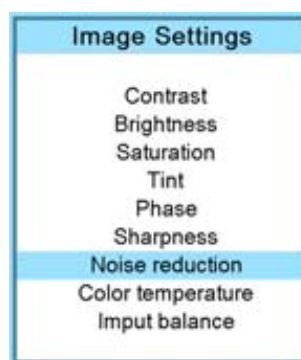

Image 9-30

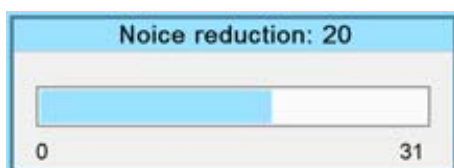

Image 9-31

### 9.3.8 Color temperature

#### What can be done ?

The color temperature can be selected according to the type of source:

There are 5 different preset color temperatures:

- Projector white
- computer : 9300 K
- Video : 6500 K
- Film : 5400 K
- Broadcast : 3200 K

These calibrated presets can be selected and will provide optimum color tracking, the projector allows however the setting of a personal color temperature, this is done in *custom balance*



Color temperature selection is only possible when Color space is OFF



#### Color temperature

The coloration (reddish, white, bluish, greenish, etc.) of white in an image, measured using the Kelvin (degrees K) temperature scale. Higher temperatures output more light.

#### 9.3.8.1 Predefined color temperature



Projector white will provide maximum projector light output. The calibrated 'Broadcast', 'Film', 'Video' and 'Computer' presets will provide optimum color tracking.

#### How to select?

1. Press **MENU** to activate the menus.
2. Use the **▲** or **▼** key to select *Image* and press **ENTER**.
3. Use the **▲** or **▼** key to select *Image settings* and press **ENTER**.
4. Use the **▲** or **▼** key to select *Color temperature* and press **ENTER**.
5. Use the **▲** or **▼** key to select a predefined color temperature value, e.g. Video, and press **ENTER**.

The colors of the image is switched to the selected value.

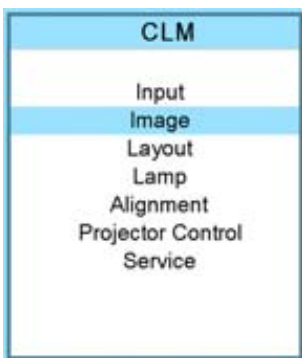

Image 9-32



Image 9-33

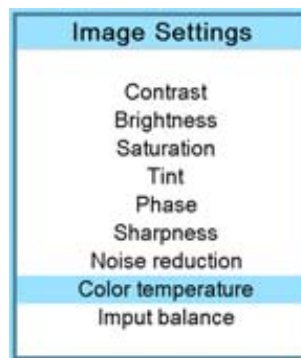

Image 9-34



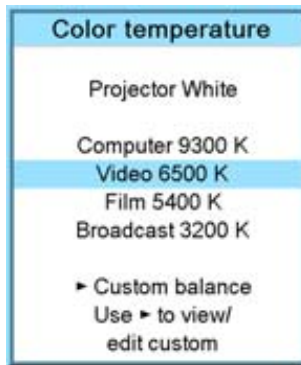

Image 9-35

### 9.3.8.2 Set a custom color temperature

#### How to enter a custom value?

1. Press **MENU** to activate the menus.
2. Use the **▲** or **▼** key to select *Image* and press **ENTER**.
3. Use the **▲** or **▼** key to select *Image settings* and press **ENTER**.
4. Use the **▲** or **▼** key to select *Color temperature* and press **ENTER**.
5. Use the **▲** or **▼** key to select *Custom balance* and press **►**.

The Gain adjustment bar scales are displayed.

6. Adjust gain red with **◀** or **▶** key and gain blue with **▲** or **▼** key. Adjust gain blue in the same way as gain red.
7. When gain adjustment is finished press **ENTER**.

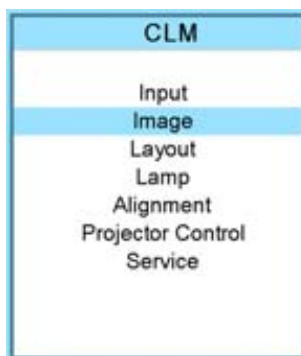

Image 9-36



Image 9-37

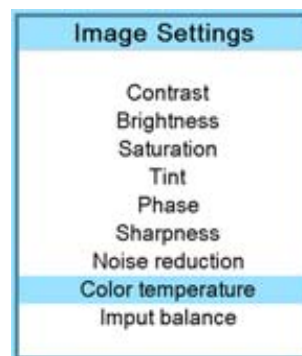

Image 9-38

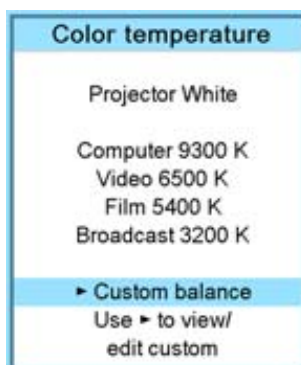

Image 9-39



Image 9-40

### 9.3.9 Input balance

#### Overview

- Introduction to Input Balance
- Adjusting the input balance

#### 9.3.9.1 Introduction to Input Balance

##### Introduction: Unbalanced color signals

When transporting signals, there is always a risk of deterioration of the information contained in the signals.

In case of information contained in the amplitude of the signals which is the case of data color signals (R, G, B), image 9-41, we are quite sure that the amplitude of these color signals is subject to alterations.

An example of alteration may be a DC component added to the signal, in the form of a DC offset repositioning the black level, since this **black level** (“**brightness**”) will become crucial later on (clamping circuit) it will result in “black not being black”.

Another value that is subject to alteration is the amplitude of the signal, resulting in an altered “Gain” of the signal (“**white level**” or **contrast**).

The alterations of the three color signals will happen independently i.e. the colors will end to be unbalanced, image 9-42

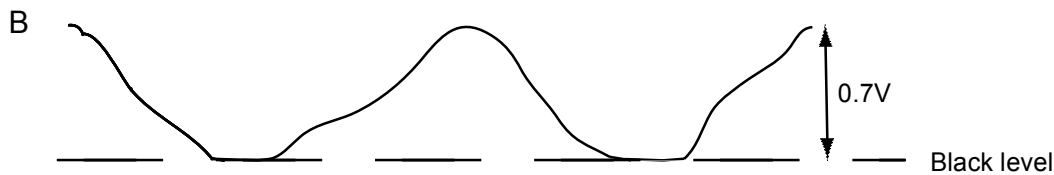

Image 9-41

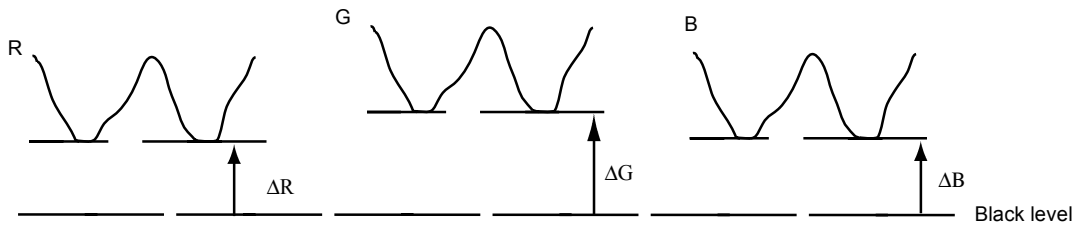

Image 9-42



One can conclude here that a good color tracking can only be met by using three previously (input) balanced color signals

#### Analog Digital Conversion

The analog color signals must pass through an Analog/Digital conversion circuit prior to any digital processing in the PMP.

A typical ADC transforms the analog value into an 8 bit coded digital signal.

The graphic shows that when converting a signal containing a DC offset component the range of the converter is not optimally used.

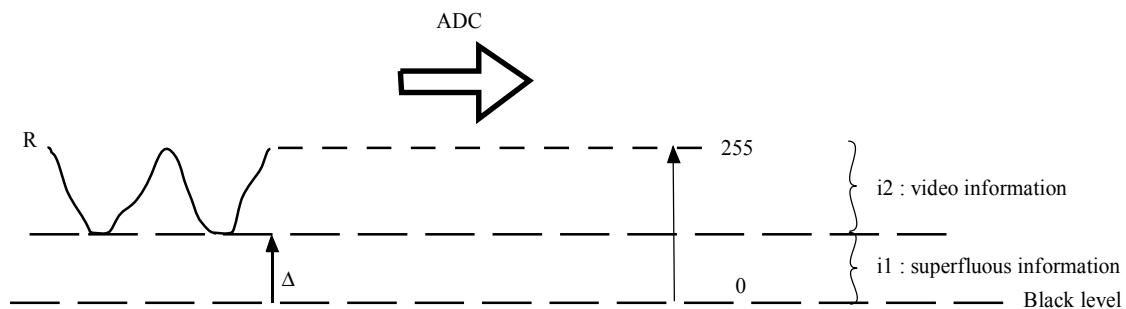

Image 9-43



One can conclude here that a good data conversion can only be met by using three previously (input) balanced color signals

### The objective of input balancing

The objective in input balancing is to “set” the same black level and the same white level for the three colors of a particular input source.



**Black level setting : brightness**

**White level setting : contrast**

The same absolute black and white level for the three colors allows the same reference for Brightness and Contrast control of the picture !

These two references also set the range in which the ADC will work for that particular source (this explains also why each input balance setting is linked to a particular source and thus saved in the image file).

### 9.3.9.2 Adjusting the input balance

#### How can it be done ?

To balance the three color signals of a particular source there are conditions; in fact we must know the black and the white level of the source i.e. :

1. The source in question must be able to generate a white signal, ideally a 100% white (background) full screen pattern
2. The source in question must be able to generate a black signal, ideally a 100% black (background) full screen pattern

A



B

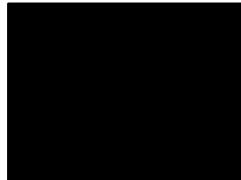

Image 9-44

**White balance :** In the projector, we will set the contrast for each color until we get a 100% light output picture when projecting a 100% white image (image A)

**Black balance :** In the projector, we will set the brightness for each color until we get a 0% light output picture when projecting a 100% black image (image B).



The changeover from min to max is indicated by the apparition of bright spots also called “digital noise”



An alternative to a full screen White/black pattern is the standard gray scale pattern, the white bar will be used for white balance and the black bar for black balance.

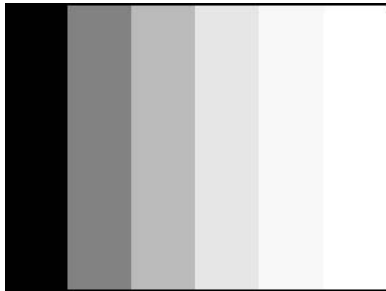

Image 9-45

### Black balance

1. Press **MENU** to activate the menus.
2. Use the **▲** or **▼** key to select *Image* and press **ENTER**.
3. Use the **▲** or **▼** key to select *Image settings* and press **ENTER**.
4. Use the **▲** or **▼** key to select *Input balance* and press **ENTER**.
5. Do you want to use an internally generated test pattern ?  
If yes, Use the **▲** or **▼** key to select *Test pattern* and press **ENTER** to toggle between [on] and [off]  
If no, Adjust on the selected source.
6. Use the **▲** or **▼** key to select *Black balance* and press **ENTER**.  
Depending whether a test pattern is selected or not, the adjustment image is displayed.
7. Toggle with **▲** or **▼** key to select *Black balance red*.

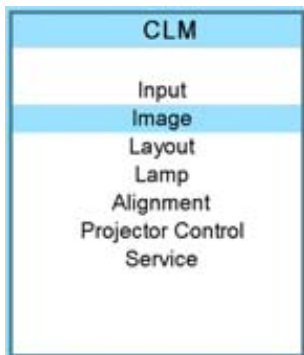

Image 9-46



Image 9-47

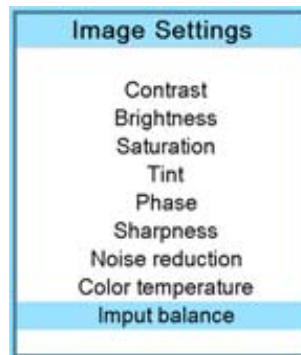

Image 9-48

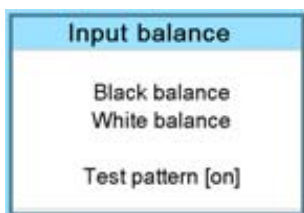

Image 9-49

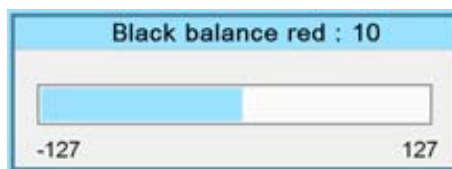

Image 9-50

8. Adjust the red black level on a minimal value
9. Toggle with **▲** or **▼** key to *Black balance blue* and adjust the blue black level on a minimal value.  
**Note:** This minimal value is not necessary, provided that the 2 other colors are not influencing too much the color to be adjusted, in fact the aim is to minimize the effect of the two other colors since there is a risk of reaching too soon the 50% transition due to the contribution of these two other colors signals.
10. Toggle with **▲** or **▼** key to *Black balance green* and adjust the Green black level until bright spots appear on the screen.
11. Toggle with **▲** or **▼** key to *Black balance blue* adjust the Blue black level until bright spots appear on the screen.
12. Toggle with **▲** or **▼** key to *Black balance red* adjust the Red black level until bright spots appear on the screen.

The projected image should now be noisy full black



If one uses a gray scale pattern, the bright spots should appear in the black bar.

### Performing White input balance

1. Connect the source you want to project.
2. Press **MENU** to activate the menus.
3. Use the **▲** or **▼** key to select *Image* and press **ENTER**.
4. Use the **▲** or **▼** key to select *Image settings* and press **ENTER**.
5. Use the **▲** or **▼** key to select *Input balance* and press **ENTER**.
6. Do you want to use an internally generated test pattern?  
If yes, Use the **▲** or **▼** key to select *Test pattern* and press **ENTER** to toggle between [on] and [off]  
If no, select a white pattern (or gray scale as alternative).
7. Use the **▲** or **▼** key to select *White balance* and press **ENTER**.  
The white balance bar scale for a typical color is displayed.
8. Toggle with the **▲** or **▼** key to select *White balance red*.

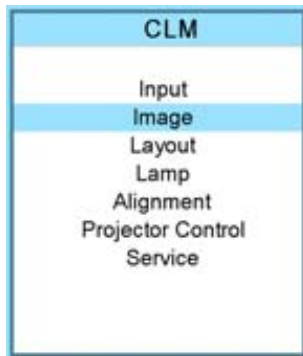

Image 9-51



Image 9-52

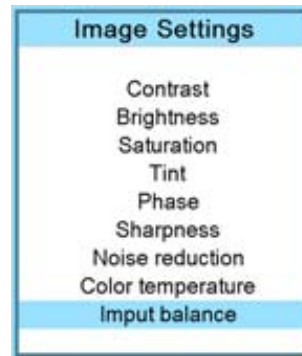

Image 9-53

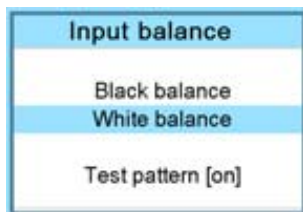

Image 9-54

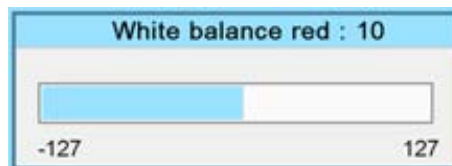

Image 9-55

9. Adjust the red white level (gain) on a minimal value
10. Toggle with **▲** or **▼** key to *White balance blue* and adjust the blue white level (gain) on a minimal value.  
**Note:** *This minimal value is not necessary, provided that the 2 other colors are not influencing too much the color to be adjusted, in fact the aim is to minimize the effect of the two other colors since there is a risk of reaching too soon the transition (bright spots) due to the contribution of these two other colors signals.*
11. Toggle with **▲** or **▼** key to *White balance green* and adjust the Green white level (gain) until bright spots appear on the screen.
12. Toggle with **▲** or **▼** key to *White balance blue* adjust the Blue white level (gain) until bright spots appear on the screen.
13. Toggle with **▲** or **▼** key to *White balance red* adjust the Red white level (gain) until bright spots appear on the screen.

The projected image should now be noisy neutral gray.

## 9.4 Aspect ratio



### Aspect ratio

Relation between the horizontal & vertical dimension in which the window will be displayed, e.g. 4 by 3 or 16 by 9. Can also be expressed as a decimal number, such as 1.77. The larger the ratio or decimal, the wider are less square the image.

### What can be done?

The aspect ratio setting forces the projector to project an image using a defined aspect ratio.

Aspect ratio	Description
4:3	Standard television format
16:9	Wide screen television format / anamorphic format
5:4	Workstation format
2.35	Film format
1.88	
1.78	Wide screen television format / anamorphic format
Custom	Any custom format can be set up

Some example images:

4/3 signal



16/9 RGB signal



Image 9-56  
Example images aspect ratio

### How to select an Aspect ratio?

1. Press **MENU** to activate the menus.
2. Use the **▲** or **▼** key to select *Image* and press **ENTER**.
3. Use the **▲** or **▼** key to select *Aspect ratio* and press **ENTER**.  
The aspect ratio menu will be displayed.
4. Use the **▲** or **▼** key to select the desired aspect ratio and press **ENTER**.

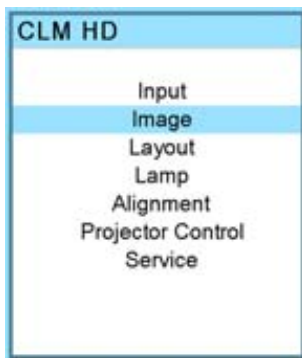

Image 9-57



Image 9-58

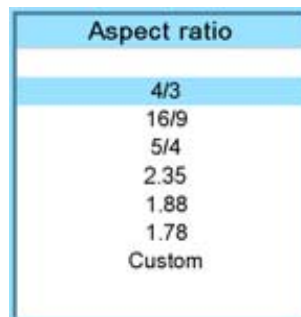

Image 9-59

### How to set up a custom aspect ratio?

1. Select first *Custom* and press **ENTER** to activate.  
The *Custom aspect ratio* dialog box opens.
2. Use the **▲** or **▼** key to adjust the vertical size of the image.

Use the ► or ◀ key to adjust the horizontal size of the image.  
When the desired aspect ratio is obtained, press **EXIT**.

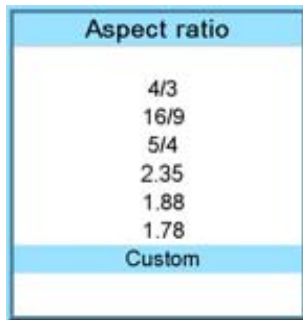

Image 9-60

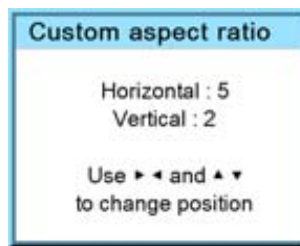

Image 9-61

## 9.5 Timings

### 9.5.1 Source timings

#### Adjustable items

- Horizontal start in pixels : number of pixels between the beginning of the input signal and the start of the video information in the signal.
- Width = Active horizontal pixels : determine the width of the window on the screen. This value is normally given in the source specifications. If not, adjust until full image is displayed (no missing pixels).
- Vertical start in lines : number of lines between the start of the input signal and start of the image on the screen.
- Height = Active vertical lines : number of horizontal lines determining the height of the projected image. this value is normally given in the specification of the source. If not, adjust until full image height is displayed (no missing lines).
- Total pixels: Total horizontal pixels in the source. If the value is wrong, sampling mistakes (small vertical bars in the projected image) will be seen in the image.
- Total lines: Total vertical lines in the source.

#### How to start up?

1. Press **MENU** to activate the menus.
2. Use the ▲ or ▼ key to select *Image* and press **ENTER**.
3. Use the ▲ or ▼ key to select *Timings* and press **ENTER**.

The timings menu will be displayed.

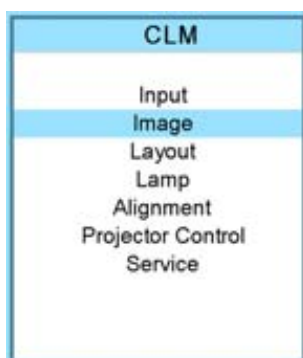

Image 9-62



Image 9-63

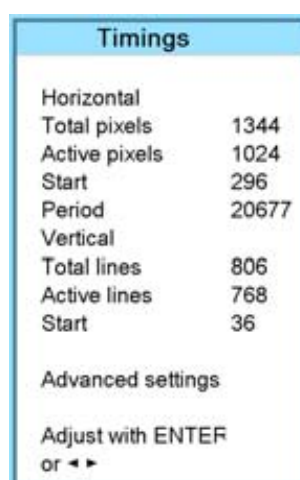

Image 9-64

4. To change a setting, use the ▲ or ▼ key to select and press **ENTER**.

The corresponding adjustment box is displayed. E.g. Horizontal total pixels.

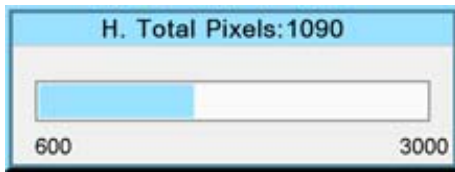

Image 9-65

5. Use the ▲ or ▼ key (or ◀ or ▶ key) to change the value.
6. Press **ENTER** to activate the new value.
7. If necessary to change other settings, repeat from step 4.

### 9.5.2 Advanced settings

#### About the advanced settings

- Clamp delay      The time between the leading edge of the clamp pulse and the locked edge of the sync pulse. Can be any value between 0 and 255.
- Clamp width      The width of the clamp pulse can be any value between 0 and 255.

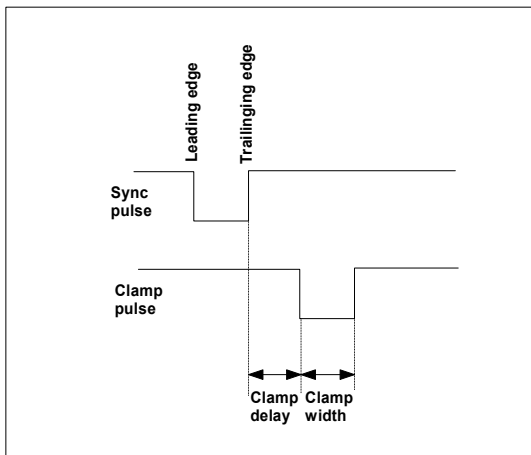

Image 9-66

- Field polarity      The field polarity function is used for interlaced images. Both rasters of the image could be shifted in a wrong way (double lines are visible in the image). This can be corrected by forcing the field polarity to [neg] or [pos].

#### How to change the clamp delay - clamp width?

1. Press **MENU** to activate the menus.
2. Use the ▲ or ▼ key to select *Image* and press **ENTER**.
3. Use the ▲ or ▼ key to select *Timings* and press **ENTER**.
4. Use the ▲ or ▼ key to select *Advanced settings* and press **ENTER**.  
The Advanced settings menu is displayed.
5. Use the ▲ or ▼ key to select *Clamp delay* or *Clamp width* and press **ENTER**.  
A progress bar appears.
6. Use the ▲ or ▼ key to change the setting.



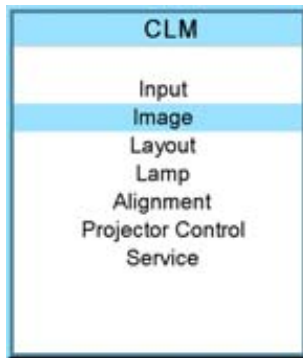

Image 9-67



Image 9-68

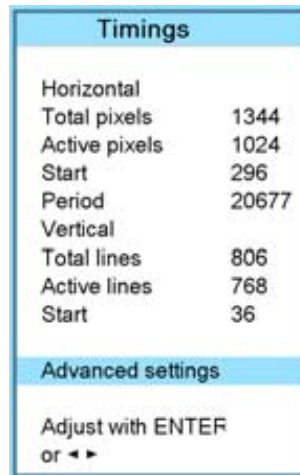

Image 9-69

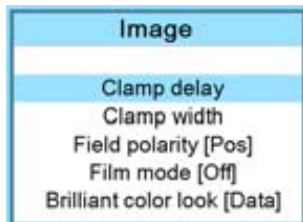

Image 9-70

### How to change the field polarity?

1. Press **MENU** to activate the menus.
2. Use the ▲ or ▼ key to select *Image* and press **ENTER**.
3. Use the ▲ or ▼ key to select *Advanced settings* and press **ENTER**.

The Advanced settings menu is displayed.

4. Use the ▲ or ▼ key to select *Field polarity* and press **ENTER** to toggle between [neg] or [pos].

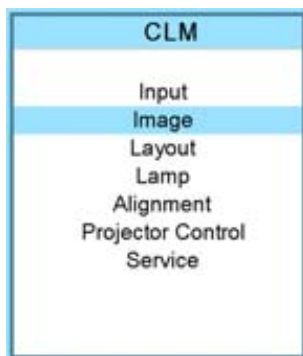

Image 9-71



Image 9-72

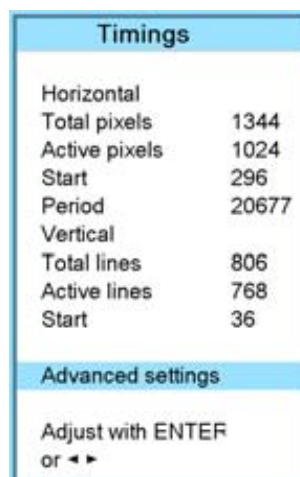

Image 9-73

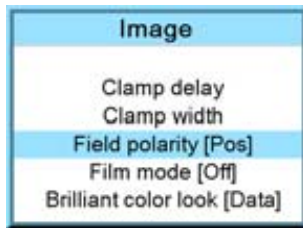

Image 9-74

### 9.5.3 Advanced settings, film mode detection

#### About film mode detection

This mode detects whether film or video is displayed.

When enabled, the hardware looks for tell-tale signs of 3:2 or 2:2 pull-down sequences. These are the result of converting cinema material recorded at 24 frames-per-second to the television frequencies of 60 or 50 interlaced fields per second respectively. When FILM conversion is detected, the original 24 frames-per-second are restored. This avoids deinterlacing artefacts, and results in a perfect artefact-free display. Note that in some cases (video clips, scrolling newstickers,...) FILM and VIDEO material are mixed on one screen. This may confuse the detector and cause it to go into FILM restoration mode. This will cause "jaggies" or motion artefacts. In such cases, disabling FILM mode processing is the best cure.



---

**Film mode detection is only for interlaced sources.**

---



---

#### 3:2 pull-down

Method used to map the 24 fps of film onto the 30 fps (60 fields) or 25 fps (50 fields), so that one film frame occupies three video fields, the next two, etc. It means the two fields of every other video frame come from different film frames making operations such as rotoscoping impossible, and requiring care in editing. Some sophisticated equipment can unravel the 3:2 sequence to allow frame-by-frame treatment and subsequently re-compose 3:2. The 3:2 sequence repeats every five video frames and four film frames, the latter identified as A-D. Only film frame A is fully on a video frame and so exists at one time code only, making it the editable point of the video sequence.

---



---

#### 2:2 pull-down

The process of transferring 24-frames/sec film format into video by repeating each frame (used for PAL DVD's) as two video fields. ( AD )

---



---

#### Artefacts

Undesirable elements or defects in a video picture. These may occur naturally in the video process and must be eliminated in order to achieve a high-quality picture. Most common in analog are cross color and cross luminance. Most common in digital are macroblocks, which resemble pixelation of the video image.

---

#### How to set up

1. Press **MENU** to activate the menus.
2. Use the **▲** or **▼** key to select *Image* and press **ENTER**.
3. Use the **▲** or **▼** key to select *Advanced settings* and press **ENTER**.  
The Advanced settings menu is displayed.
4. Use the **▲** or **▼** key to select *Film mode* and press **ENTER** to toggle between [auto] or [off].

- Auto Detects for film and it starts to avoid deinterlacing artefacts, and it results in a perfect artefact-free display.
- Off no detection for film mode.

When film with a banner is projected at the same time, and film mode is auto, the banner will shown possible artefacts as the software will detect a film.

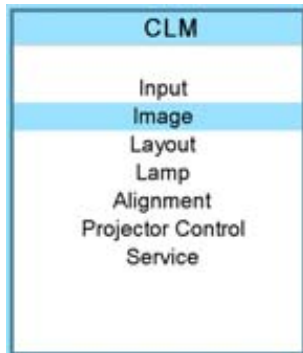

Image 9-75

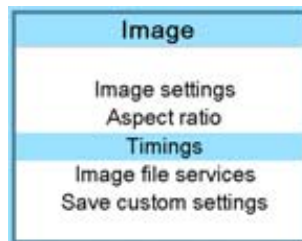

Image 9-76

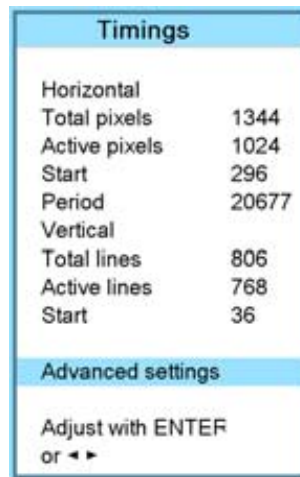

Image 9-77

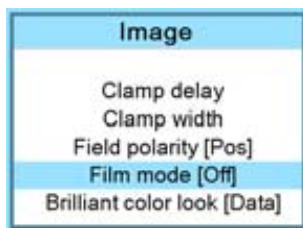

Image 9-78

#### 9.5.4 Advanced setting, brilliant color look

##### What can be done ?

The BrilliantColor™ technology is configured to process the spoke regions of the color wheel as a secondary color which improves the brightness of the display and gives the viewer a truly life-like image. The look means the shape of the curve of white added to the image. The amount of added white can be different in the low light than in the high lights. Some predefined looks, optimized for either computer images or video images are selectable with the brilliant color look function.

Select [data] when projecting computer images.

Select [Vid 1] or [Vid 2] when producing video images.

The brilliant color look setting is stored per source.

##### How to switch

1. Press **MENU** to activate the menus.
2. Use the **▲** or **▼** key to select *Image* and press **ENTER**.
3. Use the **▲** or **▼** key to select *Advanced settings* and press **ENTER**.

The Advanced settings menu is displayed.

4. Use the **▲** or **▼** key to select *Brilliant color look* and press **ENTER** to toggle between [Data] or [Vid. 1] or [Vid 2].

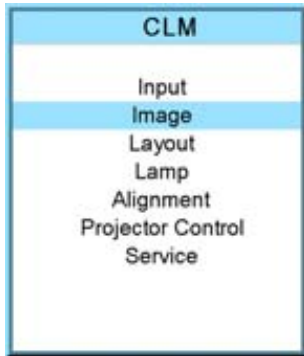

Image 9-79

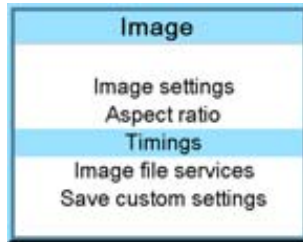

Image 9-80

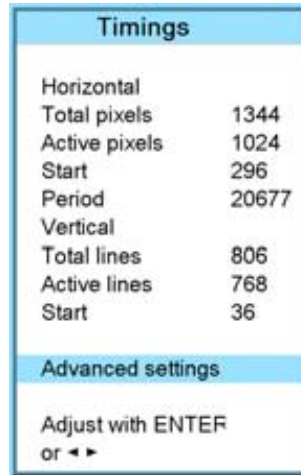

Image 9-81

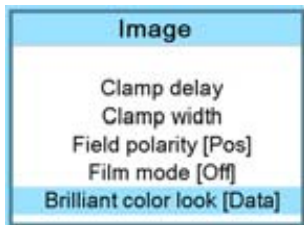

Image 9-82

## 9.6 Image files services

### Overview

- Files and file manipulations
- Manual Load file
- Delete file
- Delete all custom files
- Rename a file
- Copy a file
- File options

### 9.6.1 Files and file manipulations

#### Connecting a new source.

Before using a new source, a correct file has to be installed. The projector's memory contains a list of files corresponding to the most used sources. When the new source corresponds with one of these files, the file can be loaded and saved for future use. When there is a little difference, the file can also be loaded and then edited until the source specs are reached.

VESA standards and video standards are pre-programmed.

#### Possible file Manipulations

The following file manipulations are possible :

- Load : installation of a file for a new source.
- Rename : renaming a file.
- Delete : deleting a file (only custom files)
- Delete all : delete all custom files
- Options : way of loading a file when a source is selected.

A loaded file can be edited via the Timings menu. Once a file is edited, it will be saved with the same name as the original file, followed by a sequence number between rounded brackets.

## 9.6.2 Manual Load file

### How to load?

1. Press **MENU** to activate the menus.
2. Use the **▲** or **▼** key to select *Image* and press **ENTER**.
3. Use the **▲** or **▼** key to select *File services* and press **ENTER**.  
The File service menu is displayed.
4. Use the **▲** or **▼** key to select *Manual load* and press **ENTER**.  
The manual load window opens.

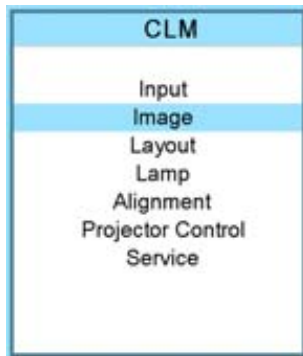

Image 9-83

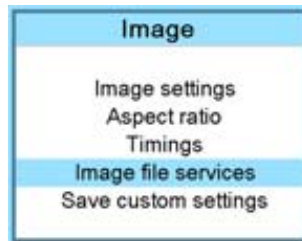

Image 9-84

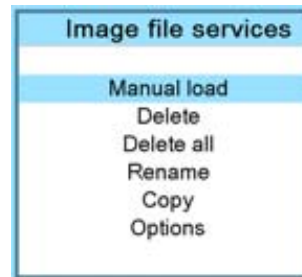

Image 9-85

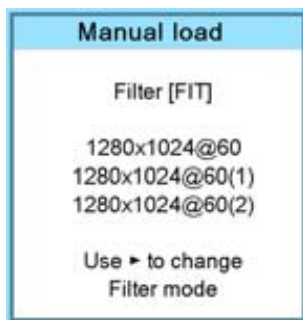

Image 9-86

Depending on the filter setup, the following is displayed:

- Fit: only fitting files for the selected source will be in the list
  - All: all files in the system will be in the list.
5. Do you want to see only the fitting file in the manual load menu?  
If yes, Select *Filter* and use **►** till [FIT] is on the menu.  
If no, Select *Filter* and use **►** till [ALL] is on the menu.
  6. Use the **▲** or **▼** key to select the appropriate file. While scrolling over the files, a preview is shown on the screen.
  7. Press **ENTER** to select.  
The selected file is loaded.

### The image is not perfect?

If the displayed image is not correct after selecting the best fitting file, go to the *Timings* menu and change the file settings.

## 9.6.3 Delete file

### How to delete?

1. Press **MENU** to activate the menus.
2. Use the **▲** or **▼** key to select *Image* and press **ENTER**.
3. Use the **▲** or **▼** key to select *File services* and press **ENTER**.  
The File service menu is displayed.
4. Use the **▲** or **▼** key to select *Delete* and press **ENTER**.

## 9. Image menu

---

The delete window opens.

5. Use the ▲ or ▼ key to select the file which must be deleted.  
**Note:** *Only custom files can be deleted.*
6. Press **ENTER** to delete the selected file.

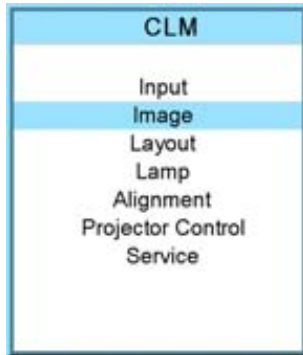

Image 9-87



Image 9-88

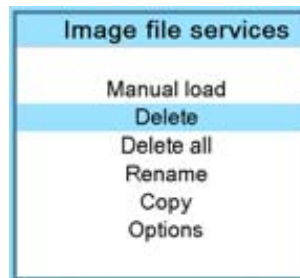

Image 9-89

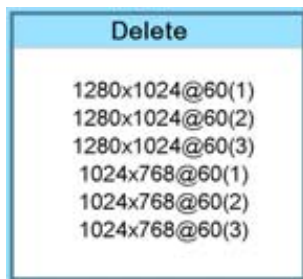

Image 9-90



**No recovery possible !**

---

### 9.6.4 Delete all custom files

#### How to delete?

1. Press **MENU** to activate the menus.
2. Use the ▲ or ▼ key to select *Image* and press **ENTER**.
3. Use the ▲ or ▼ key to select *File services* and press **ENTER**.  
The File service menu is displayed.
4. Use the ▲ or ▼ key to select *Delete all* and press **ENTER**.  
A delete all confirmation window opens.
5. Use the ▲ or ▼ key to select *Yes* if you are sure to delete all custom files and press **ENTER** to activate the selection.

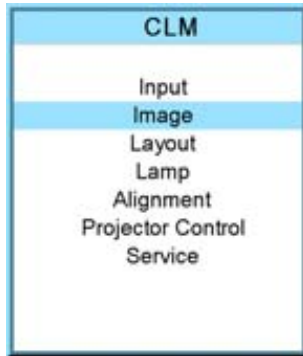

Image 9-91



Image 9-92



Image 9-93



Image 9-94

Or,

if you are not sure to delete all custom files, select *No* and press **ENTER** to activate the selection.

### 9.6.5 Rename a file

#### How to rename?

1. Press **MENU** to activate the menus.
2. Use the ▲ or ▼ key to select *Image* and press **ENTER**.
3. Use the ▲ or ▼ key to select *File services* and press **ENTER**.  
The File service menu is displayed.
4. Use the ▲ or ▼ key to select *Rename* and press **ENTER**.  
The rename window opens.
5. Use the ▲ or ▼ key to select the file which must be renamed.  
**Note:** *Only custom files can be renamed.*
6. Press **ENTER** to select.  
The rename window opens. The first character is selected.
7. Use the ▲ or ▼ key to change the selected character.  
Use the ◀ or ▶ key to selected another character.  
**Note:** *Digits can be entered with the digit keys on the remote control or on the local keypad. When a digit is entered in that way, the next character will be selected automatically.*
8. Press **ENTER** to finalize the rename action.

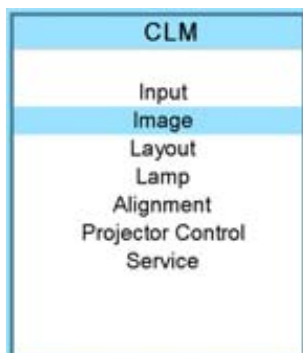

Image 9-95



Image 9-96

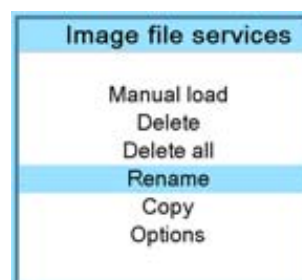

Image 9-97

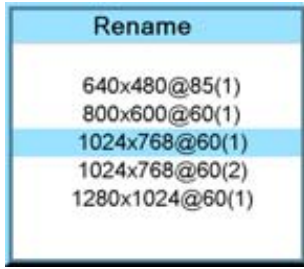

Image 9-98



Image 9-99

### 9.6.6 Copy a file

#### How to copy?

1. Press **MENU** to activate the menus.
2. Use the **▲** or **▼** key to select *Image* and press **ENTER**.
3. Use the **▲** or **▼** key to select *File services* and press **ENTER**.  
The File service menu is displayed.
4. Use the **▲** or **▼** key to select *Copy* and press **ENTER**.  
The copy window opens.
5. Use the **▲** or **▼** key to select the file which must be copied.
6. Press **ENTER** to select.

The copy window opens. The first character is selected.

7. Use the **▲** or **▼** key to change the selected character.  
Use the **◀** or **▶** key to selected another character.

**Note:** *Digits can be entered with the digit keys on the remote control or on the local keypad. When a digit is entered in that way, the next character will be selected automatically.*

8. Press **ENTER** to finalize the copy action.

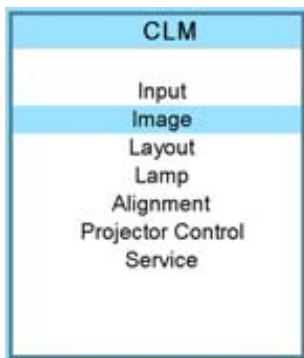

Image 9-100



Image 9-101

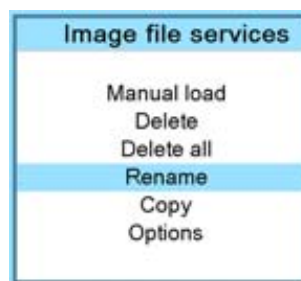

Image 9-102

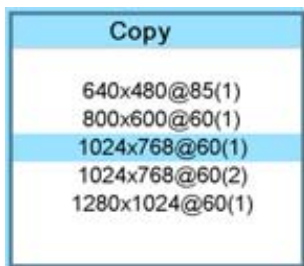

Image 9-103



Image 9-104

### 9.6.7 File options

#### How to set the options?

1. Press **MENU** to activate the menus.



2. Use the ▲ or ▼ key to select *Image* and press **ENTER**.
3. Use the ▲ or ▼ key to select *Image services* and press **ENTER**.  
The Image service menu is displayed.
4. Use the ▲ or ▼ key to select *Options* and press **ENTER**.

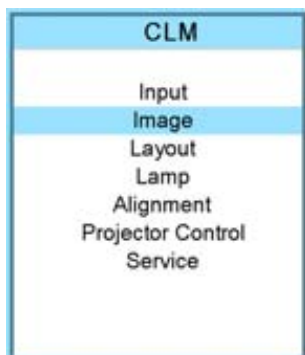

Image 9-105



Image 9-106

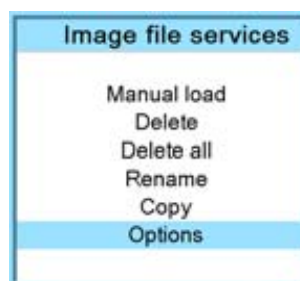

Image 9-107

The options window opens.

5. Use the ▲ or ▼ key to select *Load file* and press **ENTER** to toggle between [Automatic], [Manual] and [Custom only].
  - [Automatic]: correct file will be loaded automatically.
  - [Manual]: correct file has to be loaded manually.
  - [Custom only]: correct file will be loaded automatically out of the available custom files.

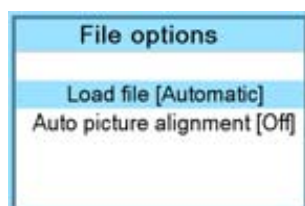

Image 9-108

6. Use the ▲ or ▼ key to select *Auto picture alignment* and press **ENTER** to toggle between [Off], [Always] and [File load].

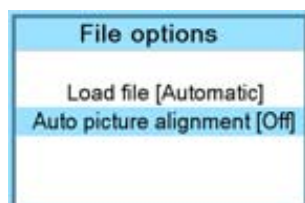

Image 9-109

- [Off]: no auto picture alignment activated.
- [Always]: always auto picture alignment activated. When sync disappears and comes back, an auto picture alignment is executed.
- [Load file]: auto picture alignment executed each time a new file is loaded.

## 9.7 Save custom settings

### What is done?

The current custom settings can be saved to the internal backup device in the same way as it would be done when the projector was switched to standby.

### How to save

1. Press **MENU** to activate the menus.
2. Use the ▲ or ▼ key to select *Image* and press **ENTER**.
3. Use the ▲ or ▼ key to select *Save custom settings* and press **ENTER**.

## 9. Image menu

---

The custom settings are written to the internal backup device. A message menu "Save data ..." is displayed during the save operation.



Image 9-110

# 10. LAYOUT MENU

## Overview

- Overview flow
- Main window
- PIP window
- Layout file services

## 10.1 Overview flow

### Overview

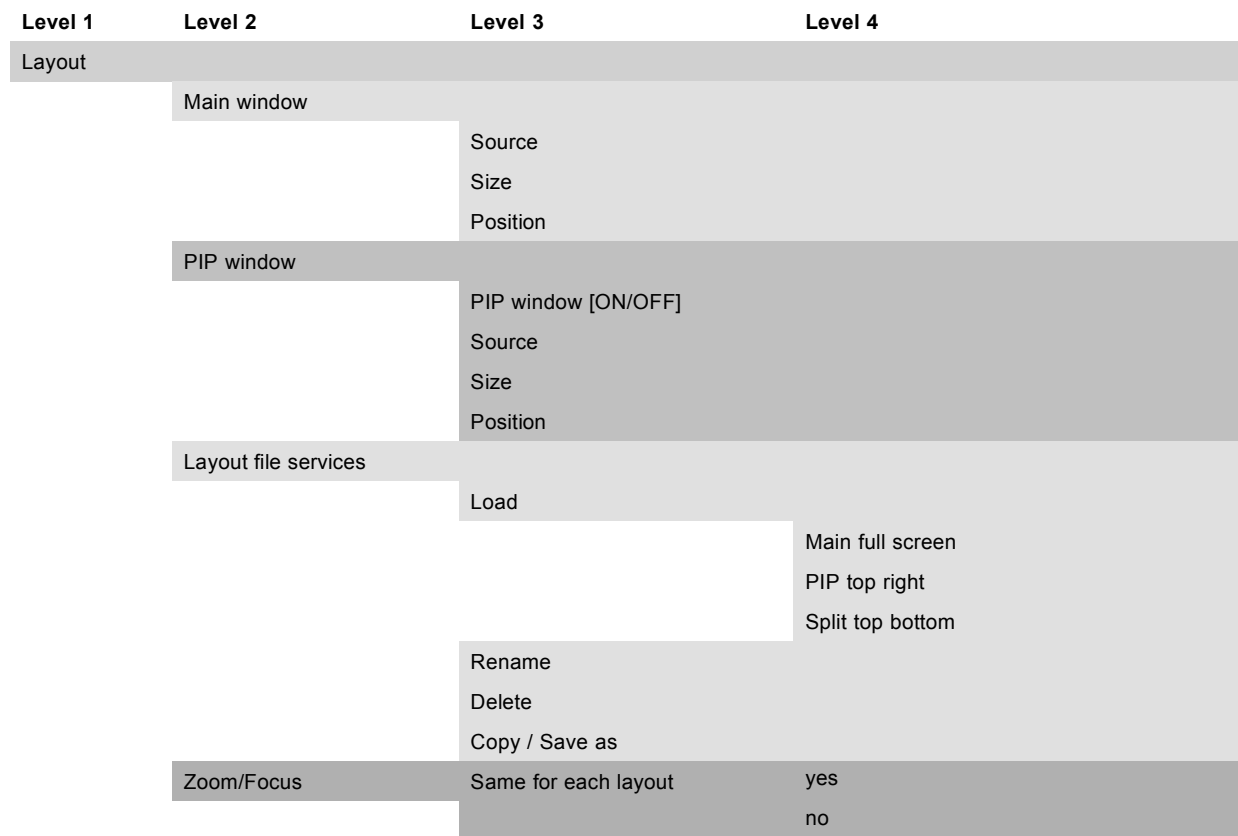

## 10.2 Main window

### Overview

- Source selection
- Size adjustment
- Position adjustment

### When active layout is read only

When the active layout is a read only layout, the projector will ask to create a new layout.

Use the ▲ or ▼ key to select *Yes* or *No* and press **ENTER**.

If *Yes* is selected an *Enter layout name* window opens.

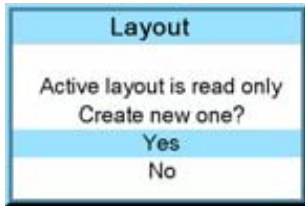

Image 10-1

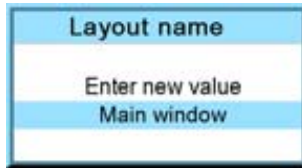

Image 10-2

The first character is highlighted. Use the ▲ or ▼ key to select the desired character and press ◀ or ▶ key to select the next character in the name.

Press **EXIT** to return. The new file is generated.

### 10.2.1 Source selection

#### What can be done ?

The source of the main window can be selected via the *Main window* menu.

#### How to select a source

1. Press **MENU** to activate the menus.
2. Use the ▲ or ▼ key to select *Layout* and press **ENTER**.
3. Use the ▲ or ▼ key to select *Main Window* and press **ENTER**.

The main window opens.

4. Use the ▲ or ▼ key to select *Source* and press **ENTER**.

The source selection window opens.

5. Use the ▲ or ▼ key to select the desired source and press **ENTER** to activate.

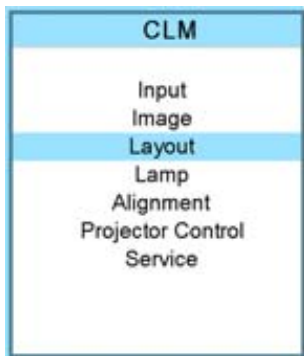

Image 10-3

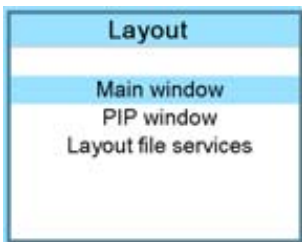

Image 10-4

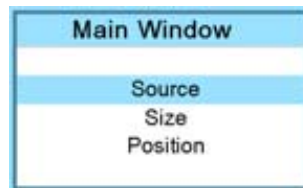

Image 10-5

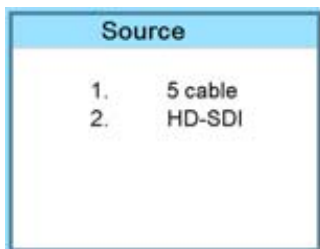

Image 10-6

### 10.2.2 Size adjustment

#### What can be done?

The size of the main window can be adjusted until the desired window dimensions are reached.

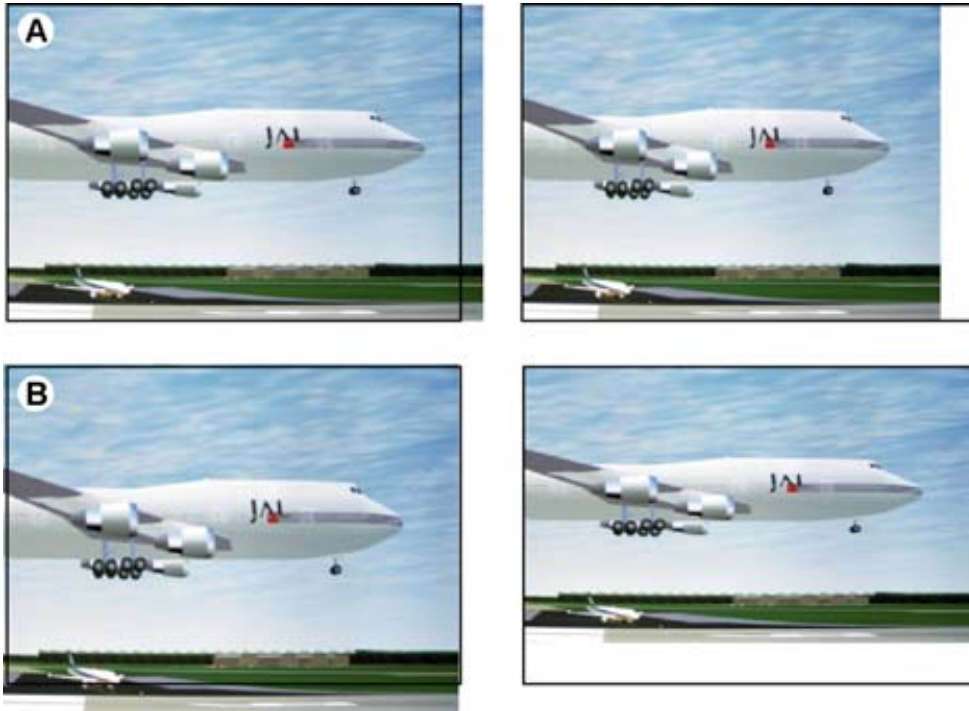

Image 10-7  
Size adjustment main window

- A width adjustment  
B height adjustment

The size can be changed with respect to the original aspect ratio.

### How to adjust with respect to the original aspect ratio?

1. Press **MENU** to activate the menus.
2. Use the ▲ or ▼ key to select *Layout* and press **ENTER**.
3. Use the ▲ or ▼ key to select *Main Window* and press **ENTER**.

The main window opens.

4. Use the ▲ or ▼ key to select *Size* and press **ENTER**.

The size adjustment window opens.

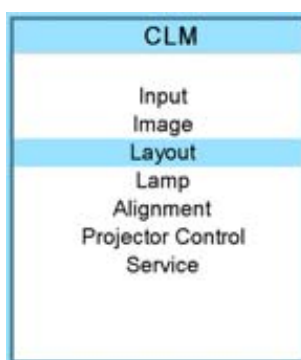

Image 10-8

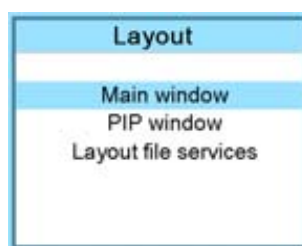

Image 10-9

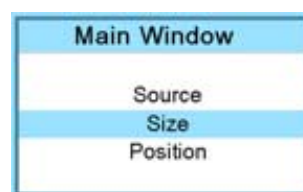

Image 10-10

5. Toggle with **ENTER** till Lock is set to [x].

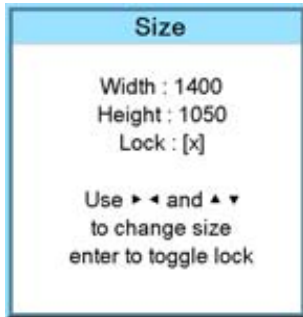

Image 10-11

[ ] = no lock between height and width.

[x] = width and height are locked.

- Use ► ◀ or ▲ ▼ to adjust the size with respect to the original aspect ratio. When the desired size is reached, press **EXIT**.

A Save window opens.

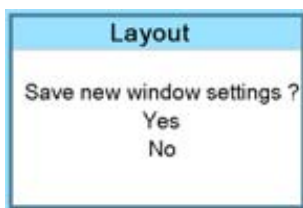

Image 10-12

### How to adjust height and width separately?

- Press **MENU** to activate the menus.
- Use the ▲ or ▼ key to select *Layout* and press **ENTER**.
- Use the ▲ or ▼ key to select *Main Window* and press **ENTER**.  
The main window opens.
- Use the ▲ or ▼ key to select *Size* and press **ENTER**.  
The size adjustment window opens.

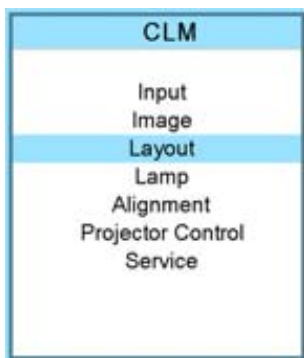

Image 10-13

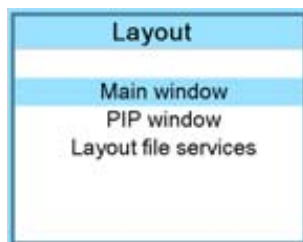

Image 10-14

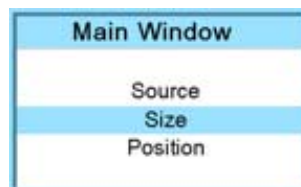

Image 10-15

- Toggle with **ENTER** till Lock is set to [ ].

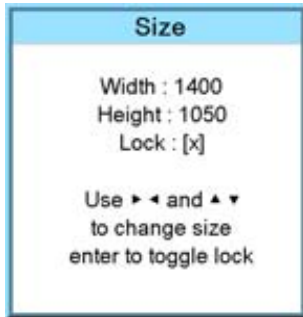

Image 10-16

[ ] = no lock between height and width.

[x] = width and height are locked.

- Use the ▲ or ▼ key to adjust the height.  
Use the ◀ or ▶ key to adjust the width.  
When the desired size is reached, press **EXIT**.

A Save window opens.

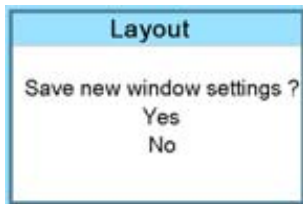

Image 10-17

- Select with the ▲ or ▼ key Yes and press **ENTER**.  
Select with the ▲ or ▼ key No, when no save is desired and press **ENTER**.

### 10.2.3 Position adjustment

#### What can be done?

The main window can be repositioned on the screen. The upper left corner is the reference.

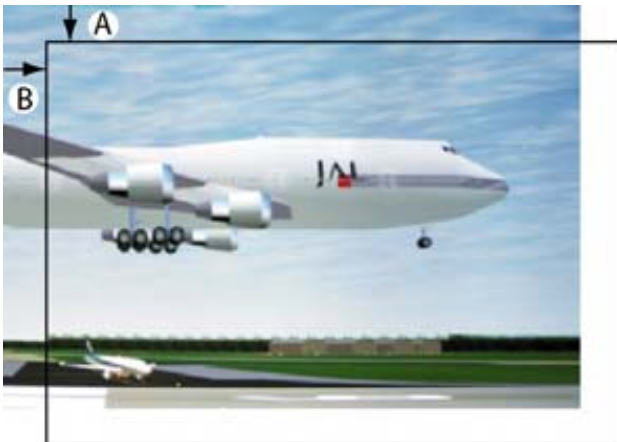

Image 10-18  
Positioning the window

#### How to position?

- Press **MENU** to activate the menus.
- Use the ▲ or ▼ key to select *Layout* and press **ENTER**.
- Use the ▲ or ▼ key to select *Main Window* and press **ENTER**.  
The main window opens.
- Use the ▲ or ▼ key to select *Position* and press **ENTER**.  
The position adjustment window opens.
- Use the ▲ or ▼ key to adjust top start point.

## 10. Layout menu

---

Use the ◀ or ▶ key to adjust left start point.  
When the desired size is reached, press **EXIT**.

A Save window opens.

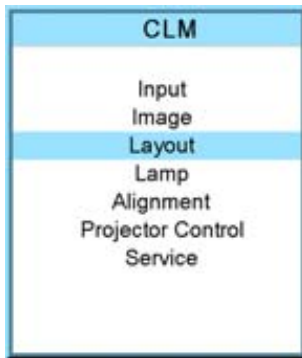

Image 10-19

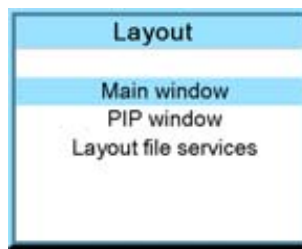

Image 10-20

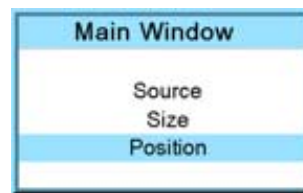

Image 10-21



Image 10-22

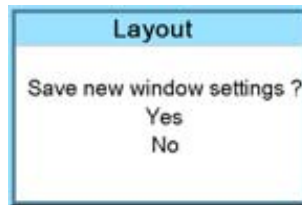

Image 10-23

6. Select with the ▲ or ▼ key **Save** and press **ENTER**.  
Select with the ▲ or ▼ key **Delete**, when no save is desired and press **ENTER**.

## 10.3 PIP window

---

### Overview

- Introduction to PIP
- Picture in Picture activation
- Picture in Picture source selection
- Picture in Picture size of the window
- Picture in Picture, position window

### 10.3.1 Introduction to PIP

---



#### PiP

PiP stands for "Picture in Picture" and allows to display multiple windows containing each of them an image. The windows may be of the video or data type.

---

#### What are the different possibilities within the PiP mode ?

The input section of the projector allows a combinations of different input signals which may be projected in the 2 windows of the PiP screen. The PiP window can be placed anywhere, with any dimensions, on the screen by changing its position and its size.



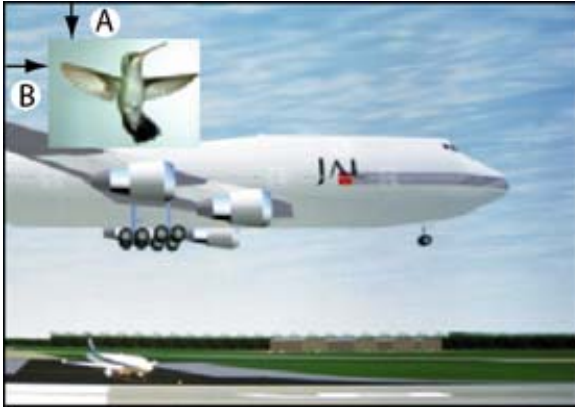

Image 10-24  
Position of PIP

- A Top position  
B Left position

### 10.3.2 Picture in Picture activation

#### How to activate PIP?

1. Press **MENU** to activate the menus.
2. Use the **▲** or **▼** key to select *Layout* and press **ENTER**.
3. Use the **▲** or **▼** key to select *PIP Window* and press **ENTER**.  
The PIP window opens.
4. Use the **▲** or **▼** key to select *On* or *Off* and press **ENTER** to toggle between [On] and [Off].

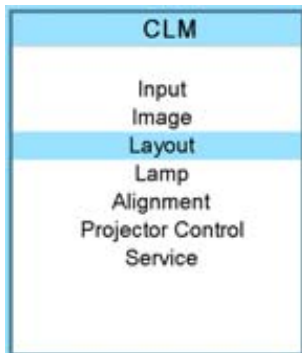

Image 10-25

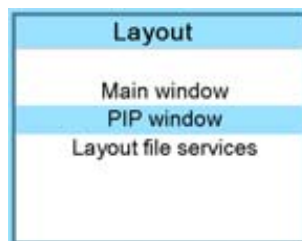

Image 10-26

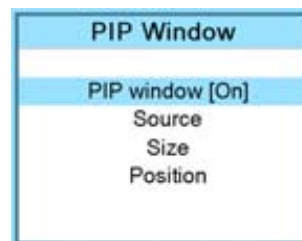

Image 10-27

5. Press **EXIT** to quit the menu.



When PIP is activated (ON state), the PIP window becomes the active window. Switching to the main window is still possible with the window button on the RCU.

### 10.3.3 Picture in Picture source selection

#### What can be done ?

The input source for the picture in picture window can be selected.

#### How to select a source

1. Press **MENU** to activate the menus.
2. Use the **▲** or **▼** key to select *Window* and press **ENTER**.
3. Use the **▲** or **▼** key to select *PIP Window* and press **ENTER**.  
The PIP window dialog opens.
4. Use the **▲** or **▼** key to select *Source* and press **ENTER**.

## 10. Layout menu

The source selection window opens.

5. Use the ▲ or ▼ key to select the desired source and press **ENTER** to activate this source.

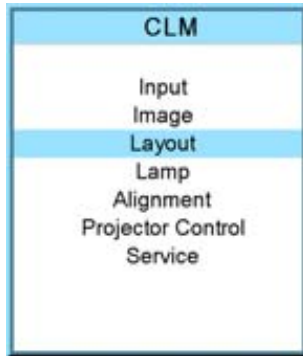

Image 10-28

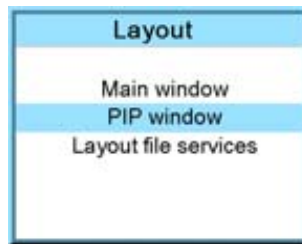

Image 10-29

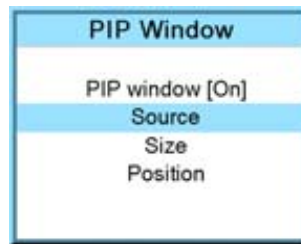

Image 10-30

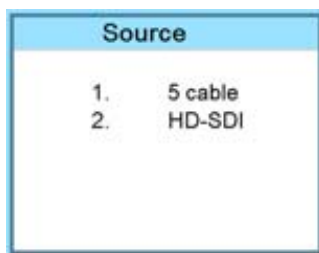

Image 10-31

### 10.3.4 Picture in Picture size of the window

#### What can be done?

The width and height of the picture in picture window can be changed till the desired dimensions are obtained.

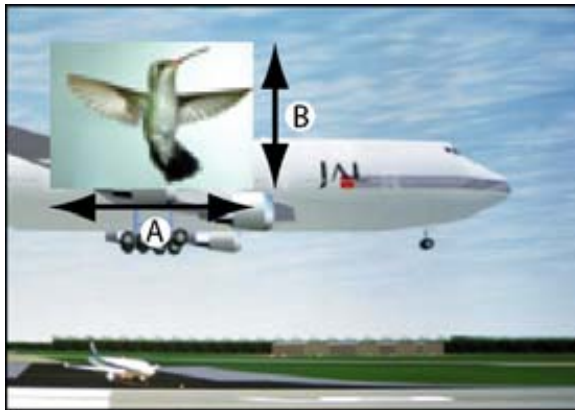

Image 10-32  
Size PIP window

- A Width PIP window
- B Height PIP window

The size of the picture in picture window can be changed with respect to the original aspect ratio of the PIP image.

Remark: when e.g. the PIP window is a 4 by 3 window and the projected image has a 16 by 9 format, then it is possible that image jumps inside the PIP window during a re-scaling. Due to the fact that the re-scale is done on the vertical dimensions of the PIP window and the image inside it will be re-scaled so that the aspect ratio is still correct.



Image 10-33  
Size PIP window remark

### How to change the size with respect to the aspect ratio?

1. Press **MENU** to activate the menu.
2. Use the **▲** or **▼** key to select *Window* and press **ENTER**.
3. Use the **▲** or **▼** key to select *PIP Window* and press **ENTER**.

The main window opens.

4. Use the **▲** or **▼** key to select *Size* and press **ENTER**.

The size adjustment window opens.

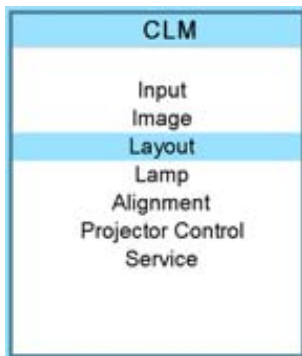

Image 10-34

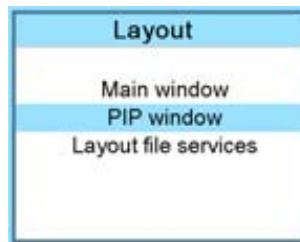

Image 10-35

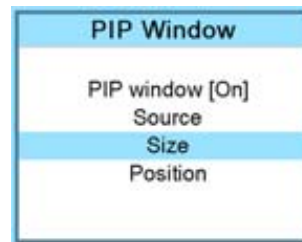

Image 10-36

5. Toggle with **ENTER** till Lock is set to [x].

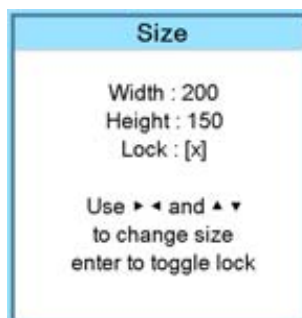

Image 10-37

[ ] = no lock between height and width.

[x] = width and height are locked.

6. Use the **▲ ▼** or **◀ ▶** key to adjust the size with respect to the aspect ratio. When the desired size is reached, press **EXIT**.

## 10. Layout menu

---

A Save window opens.

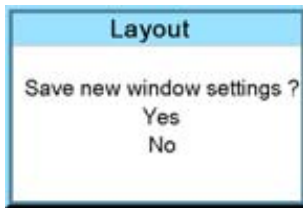

Image 10-38

7. Select with the ▲ or ▼ key Yes and press **ENTER**.  
Select with the ▲ or ▼ key No, when no save is desired and press **ENTER**.

### How to change the height and width separately?

1. Press **MENU** to activate the menus.
2. Use the ▲ or ▼ key to select *Window* and press **ENTER**.
3. Use the ▲ or ▼ key to select *PIP Window* and press **ENTER**.

The main window opens.

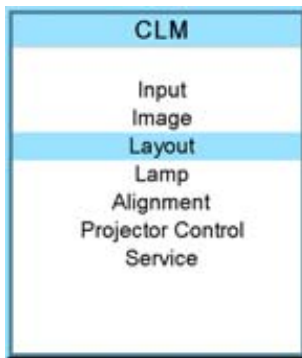

Image 10-39

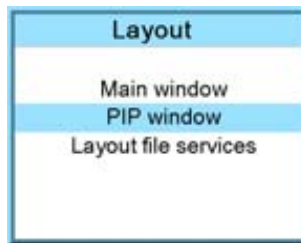

Image 10-40

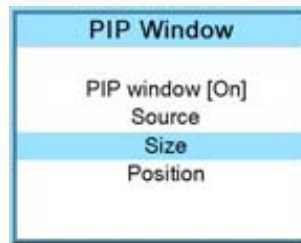

Image 10-41

4. Use the ▲ or ▼ key to select *Size* and press **ENTER**.  
The size adjustment window opens.
5. Toggle with **ENTER** till Lock is set to [ ].

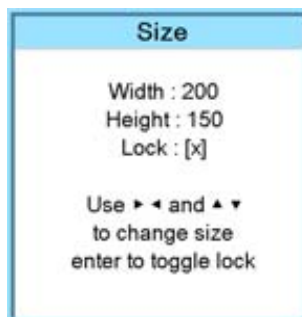

Image 10-42

[ ] = no lock between height and width.

[x] = width and height are locked.

6. Use the ▲ or ▼ key to adjust the height.  
Use the ◀ or ▶ key to adjust the width.  
When the desired size is reached, press **EXIT**.

A Save window opens.

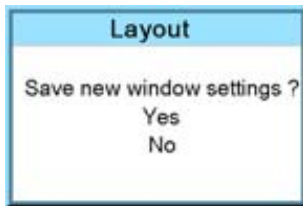

Image 10-43

7. Select with the ▲ or ▼ key Yes and press **ENTER**.  
Select with the ▲ or ▼ key No, when no save is desired and press **ENTER**.

### 10.3.5 Picture in Picture, position window

#### What can be done?

The picture in picture window can be position on any place on the display just by changing its start coordinates. The reference is the upper left corner of the window.

#### How to position?

1. Press **MENU** to activate the menus.
2. Use the ▲ or ▼ key to select *Window* and press **ENTER**.
3. Use the ▲ or ▼ key to select *PIP Window* and press **ENTER**.  
The PIP window opens.
4. Use the ▲ or ▼ key to select *Position* and press **ENTER**.  
The size adjustment window opens.
5. Use the ▲ or ▼ key to adjust Top  
Use the ◀ or ▶ key to adjust Left  
When the desired position is reached, press **EXIT**.

A Save window opens.

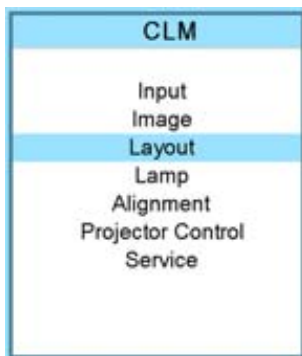

Image 10-44

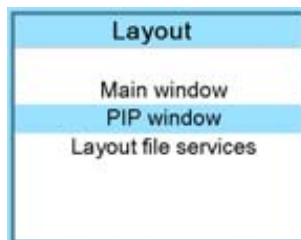

Image 10-45

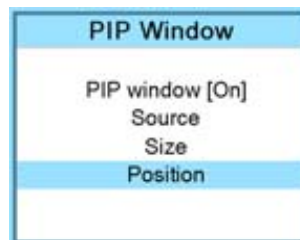

Image 10-46



Image 10-47

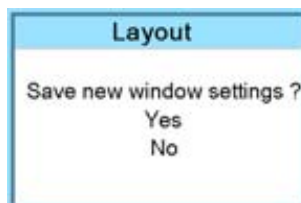

Image 10-48

6. Select with the ▲ or ▼ key Yes and press **ENTER**.  
Select with the ▲ or ▼ key No, when no save is desired and press **ENTER**.

## 10.4 Layout file services

### Overview

- Load layout
- Rename a layout
- Delete a layout
- Copy / Save as a layout

### 10.4.1 Load layout



When loading a layout which required two sources, the *PIP window On/Off* setting will be switched to **ON**.

### How to load?

1. Press **MENU** to activate the menus.
2. Use the **▲** or **▼** key to select *Window* and press **ENTER**.
3. Use the **▲** or **▼** key to select *Layout* and press **ENTER**.  
The layout services window opens.
4. Use the **▲** or **▼** key to select *Load* and press **ENTER**.  
The load layout window opens.

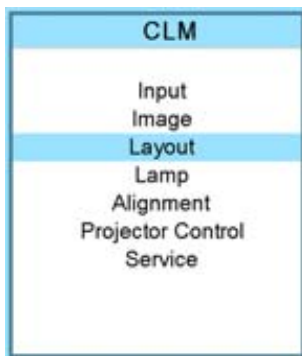

Image 10-49

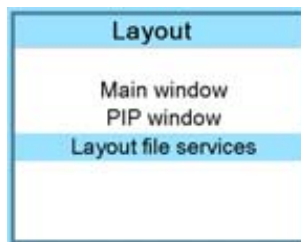

Image 10-50

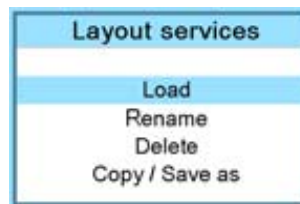

Image 10-51



Image 10-52

5. Use the **▲** or **▼** key to select the desired layout and press **ENTER** to select.

The first 4 layouts are default layouts, all others are customer created layouts. The menu shows only the first 10 layouts, but use the **▼** to scroll through the rest of the layouts until the desired layout is found.



**Rigging key + sequence number** opens directly the desired layout.

## 10.4.2 Rename a layout



Only custom created layouts can be renamed.

### How to rename?

1. Press **MENU** to activate the menus.
2. Use the **▲** or **▼** key to select *Window* and press **ENTER**.
3. Use the **▲** or **▼** key to select *Layout* and press **ENTER**.  
The layout services window opens.
4. Use the **▲** or **▼** key to select *Rename* and press **ENTER**.  
The Rename layout location window opens.
5. Use the **▲** or **▼** key to select the layout to rename and press **ENTER**.  
The edit layout name window opens. The first character is selected.
6. Use the **▲** or **▼** key to change the selected character.  
Use the **◀** or **▶** key to selected another character.  
**Note:** *Digits can be entered with the digit keys on the remote control or on the local keypad. When a digit is entered in that way, the next character is selected automatically.*
7. Press **ENTER** to save the new name.

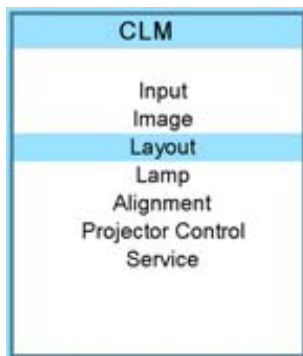

Image 10-53

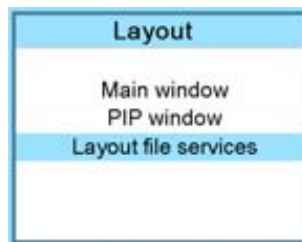

Image 10-54

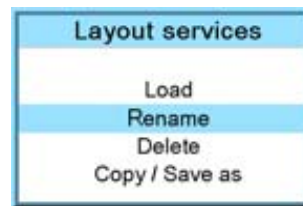

Image 10-55

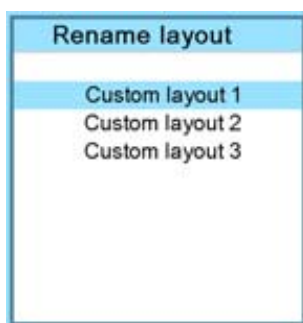

Image 10-56

## 10.4.3 Delete a layout

### What is possible?

Custom created layouts can be removed from the projector memory.

### How to delete?

1. Press **MENU** to activate the menus.
2. Use the **▲** or **▼** key to select *Window* and press **ENTER**.
3. Use the **▲** or **▼** key to select *Layout services* and press **ENTER**.

The layout services window opens.

- Use the ▲ or ▼ key to select *Delete* and press **ENTER**.

The *Delete* window opens.

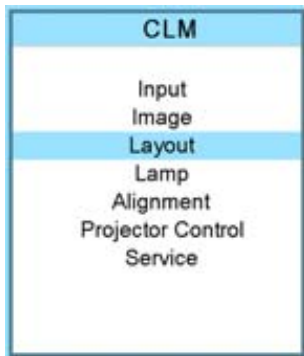

Image 10-57

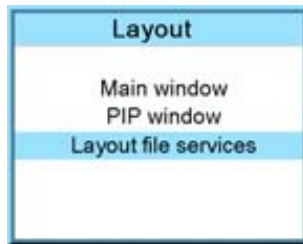

Image 10-58

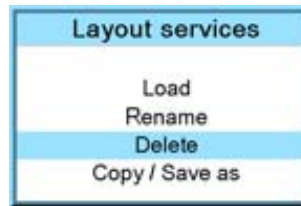

Image 10-59

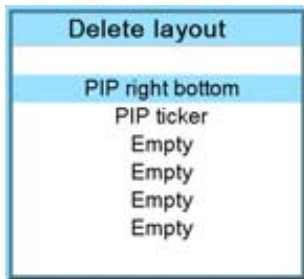

Image 10-60

The first 3 layouts are default layouts and cannot be delete.

- Use the ▲ or ▼ key to select the layout that must be deleted.
- Press **ENTER** to finalize the delete operation.

#### 10.4.4 Copy / Save as a layout

##### What is possible,

An existing layout, system layout or custom created layout, can be copied into a new file.

##### How to copy / save as?

- Press **MENU** to activate the menus.
- Use the ▲ or ▼ key to select *Window* and press **ENTER**.
- Use the ▲ or ▼ key to select *Layout* and press **ENTER**.

The layout services window opens.

- Use the ▲ or ▼ key to select *Copy/Save as* and press **ENTER**.

The Save layout location window opens.

- Use the ▲ or ▼ key to select the layout to copy/save as and press **ENTER**.

The edit layout name window opens. The first character is selected.

- Use the ▲ or ▼ key to change the selected character.  
Use the ◀ or ▶ key to selected another character.

**Note:** *Digits can be entered with the digit keys on the remote control or on the local keypad. When a digit is entered in that way, the next character is selected automatically.*

- Press **ENTER** to copy to the new name.  
The new layout will be added to the list of layouts.



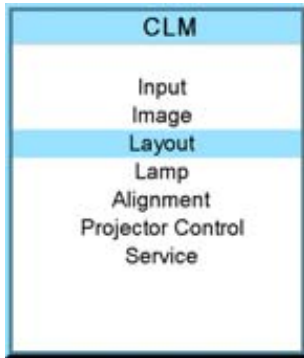

Image 10-61

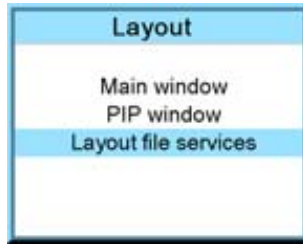

Image 10-62

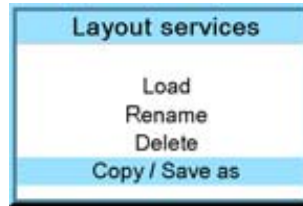

Image 10-63



Image 10-64



# 11. LAMP MENU

## Overview

- Overview flow
- Lamp power mode
- Lamp power
- Lamp Identification
- Status and run time overview lamps
- Lamp mode

## 11.1 Overview flow

### Overview

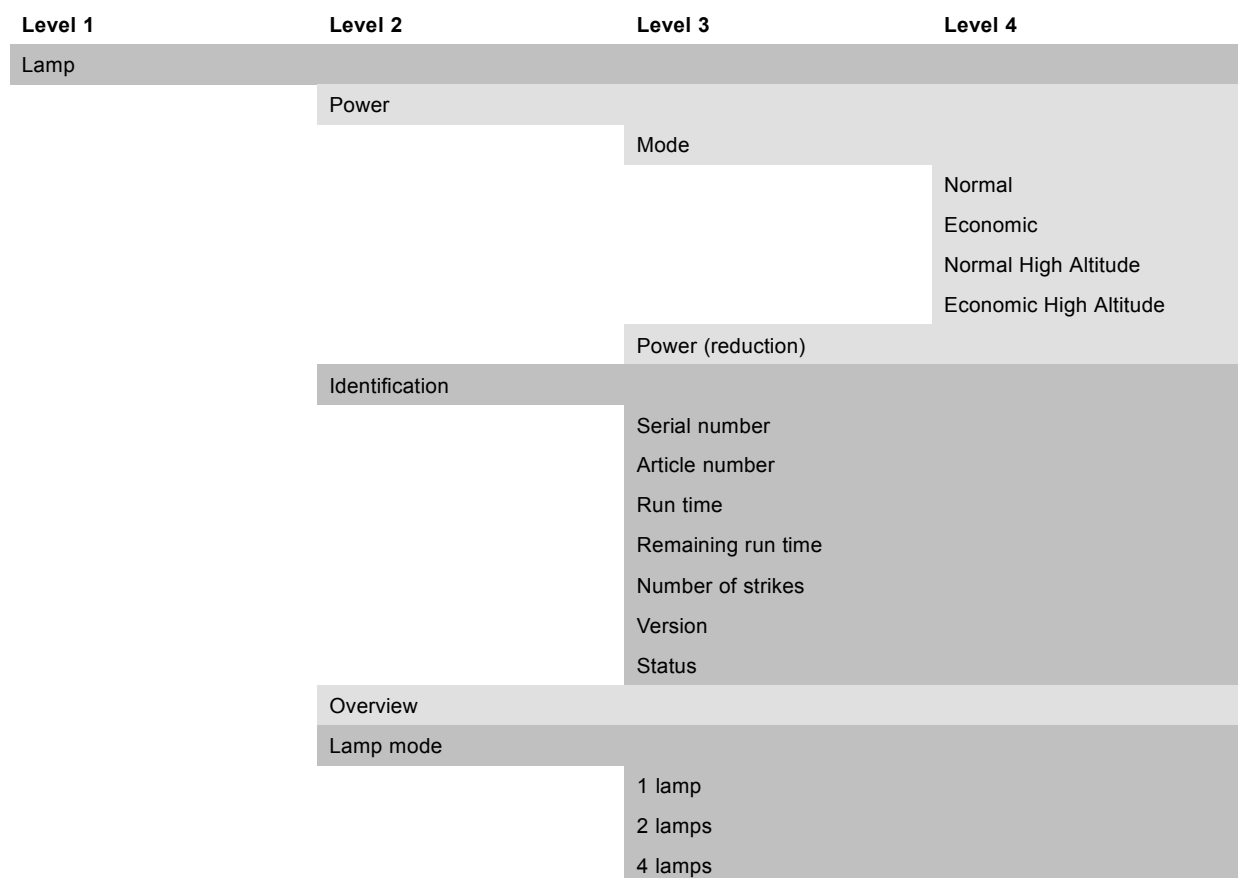

## 11.2 Lamp power mode

### What can be done?

The lamp power mode can be switched between **Normal**, **Economic**, **Normal High Altitude** and **Economic High Altitude**. When playing in Economic mode, the life time of the active lamp(s) will increase.

*Normal* : maximum allowed power is fed to the lamp(s). Maximum light output is reached in this way.

*Economic* : a reduced wattage is fed to the lamp(s). Reduced light output but a longer life time for the lamp(s).

*Normal high altitude* : maximum allowed power is fed to the lamp(s). Maximum light output is reached in this way and a correct cooling is started even when the air density is less (fans are turning faster).

*Eco high altitude* : a reduced wattage is fed to the lamp(s). Reduced light output but a longer life time for the lamp(s). A correct cooling is started even when the air density is less (fans are turning faster).

### How to switch?

1. Press **MENU** to activate the menus.
2. Use the **▲** or **▼** key to select *Lamp* and press **ENTER**.
3. Use the **▲** or **▼** key to select *Power* and press **ENTER**.
4. Use the **▲** or **▼** key to select *Mode*.
5. Press **ENTER** to toggle between [*Normal*], [*Economic*], [*Normal high altitude*] and [*Eco high altitude*].

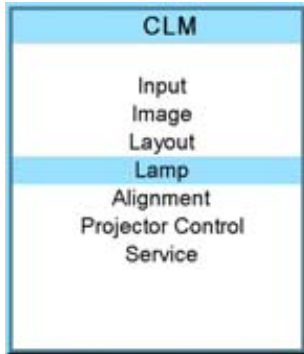

Image 11-1

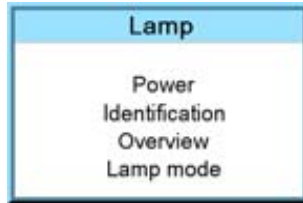

Image 11-2

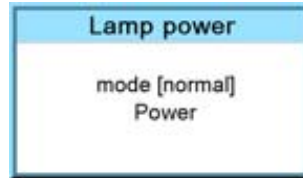

Image 11-3

## 11.3 Lamp power

---

### What can be done?

Within the normal power mode, the light output of the active lamp(s) can be reduced by reducing the lamp power between 100% and 83%.



**No lamp power adjustment possible when the *Lamp power mode* is *Economic*.**

### How to dim?

1. Press **MENU** to activate the menus.
2. Use the **▲** or **▼** key to select *Lamp* and press **ENTER**.
3. Use the **▲** or **▼** key to select *Power* and press **ENTER**.
4. Use the **▲** or **▼** key to select *Power* and press **ENTER**.  
**Note:** *Only possible when lamp mode is [Normal].*
5. Use the **▲** or **▼** key to change the lamp power.

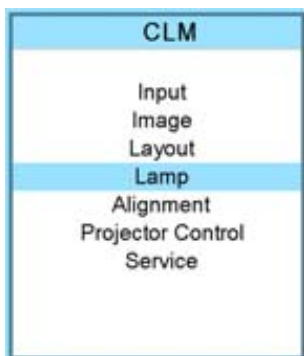

Image 11-4

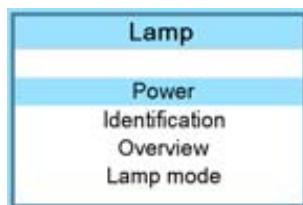

Image 11-5

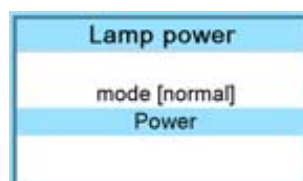

Image 11-6

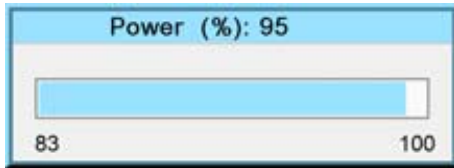

Image 11-7

### About over-temperature protection

When the projector software detects a too high lamp temperature it automatically reduce the lamp power with 20%. This reduction will be visible on the Lamp power menu.

It is possible to adjust the lamp power again to a higher value but the software will reduce the lamp power again if the temperature is still to high.

At the same time, an message will be displayed on the LCD panel.

## 11.4 Lamp Identification

### About

The lamp identification menu gives an overview of the most important parameters of the used lamps. It starts with the first lamp. Scrolling to other lamps is possible with the cursor keys.

These parameters are:

- Serial number lamp
- Article number of the used lamp
- Run time since first start up of the lamp
- Remaining run time for a safe operation of the lamp
- Number of strikes since the first start up of the lamp
- Status of the lamp



These parameters are useful when calling for a service intervention.

### How to display?

1. Press **MENU** to activate the menus.
2. Use the **▲** or **▼** key to select *Lamp* and press **ENTER**.
3. Use the **▲** or **▼** key to select *Identification* and press **ENTER**.

The identification overview is displayed.

4. Use the **◀** or **▶** key to select another lamp.

The status is given lamp per lamp.

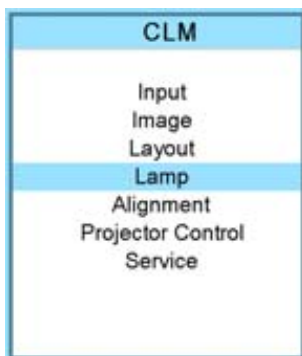

Image 11-8

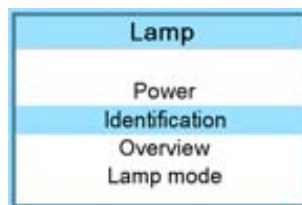

Image 11-9

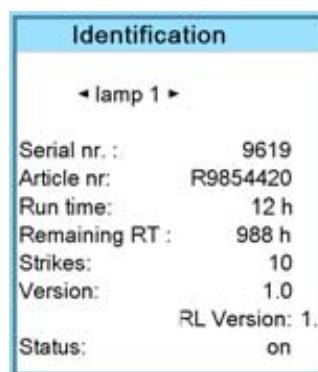

Image 11-10

## 11.5 Status and run time overview lamps

### Overview

1. Press **MENU** to activate the menus.
2. Use the **▲** or **▼** key to select *Lamp* and press **ENTER**.
3. Use the **▲** or **▼** key to select *Overview* and press **ENTER**.

The status and the run time for each lamp are displayed.

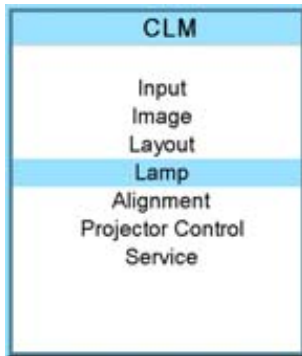

Image 11-11

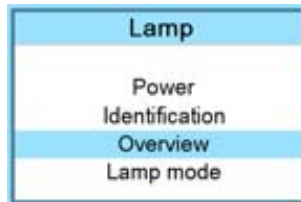

Image 11-12

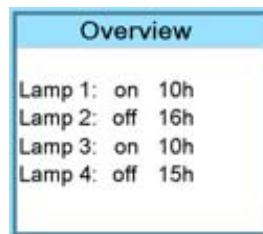

Image 11-13

## 11.6 Lamp mode

### What can be done?

In 4 lamps mode, the projector will always ignite all 4 lamps.

In 2 lamps mode, the projector will always ignite lamp 1 & 3 or 2 & 4 depending on the current run time. It will always use those with the lowest run time.

In 1 lamp mode, the projector will always ignite lamp 3 or 4, depending on the current run time. It will always use the lamp with the lowest run time.

### How to change the lamp mode

1. Press **MENU** to activate the menus.
2. Use the **▲** or **▼** key to select *Lamp* and press **ENTER**.
3. Use the **▲** or **▼** key to select *Lamp mode* and press **ENTER**.

The Lamp mode selection menu is displayed.

4. Use the **▲** or **▼** key to select the desired lamp mode and press **ENTER**.

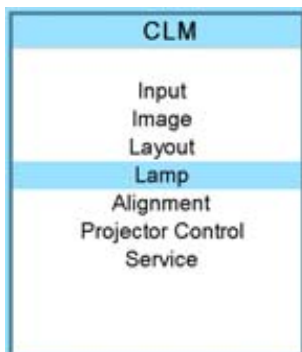

Image 11-14

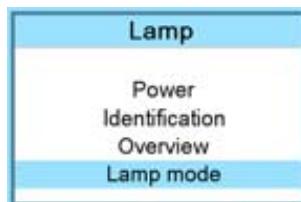

Image 11-15

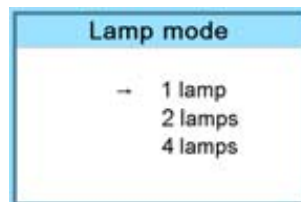

Image 11-16

# 12. ALIGNMENT MENU

## About this chapter

This chapter describes the alignment of the projector once the physical installation is finished. Via the software, the image will be perfectly aligned on the screen.

## Overview

- Overview flow
- Orientation
- Lens adjustment
- Side keystone
- Blanking
- Intensity
- Gamma
- Internal pattern
- Color space
- White peaking
- ScenergiX

## 12.1 Overview flow

### Overview

Level 1	Level 2	Level 3
Alignment		
	Orientation	
		Front Table
		Front Ceiling
		Rear Table
		Rear Ceiling
	Lens	
		Zoom/Focus
		Shift
	Side keystone	
	Blanking	
		Top
		Bottom
		Left
		Right
		Reset
	Intensity	
	Gamma	
	Internal patterns	
		Checker board
		Color bars
		Convergence
		Focus
		Full screen black
		Full screen blue

Level 1	Level 2	Level 3
		Full screen green Full screen red Full screen white Hatch Outline Purity ScenergiX
	Color space	Projector EBU SMPTE Custom
	White peaking	
	ScenergiX	Status White level Bottom Black level Show pattern Reset

## 12.2 Orientation

### What can be done?

The way of physical installation of the projector can be defined to the projector.

The following installation are possible:

- front/table
- front/ceiling
- rear/table
- rear/ceiling

### Set up the correct orientation

1. Press **MENU** to activate the menus.
2. Use the **▲** or **▼** key to select *Alignment* and press **ENTER**.
3. Use the **▲** or **▼** key to select *Orientation* and press **ENTER**.
4. Use the **▲** or **▼** key to select the correct orientation and press **ENTER**.

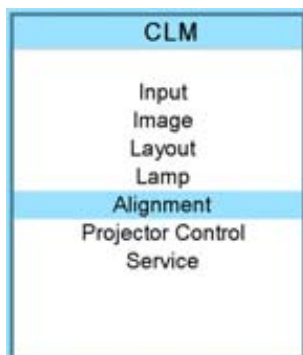

Image 12-1



Image 12-2

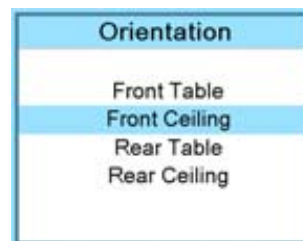

Image 12-3





For more information about the physical installation, see chapter “General”, “Projector configurations”.

## 12.3 Lens adjustment



Quick way to enter the lens adjustment setting; press the lens button on the local keypad or the remote control.

### Access to the lens adjustments

1. Press **MENU** to activate the menus.
2. Use the ▲ or ▼ key to select *Alignment* and press **ENTER**.
3. Use the ▲ or ▼ key to select *Lens* and press **ENTER**.

The lens adjustment menu is displayed.

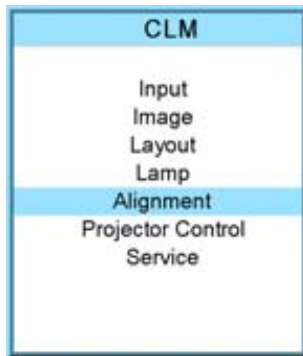

Image 12-4



Image 12-5

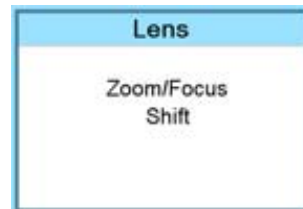

Image 12-6

### Zoom/focus the lens

1. Use the ▲ or ▼ key to select *Zoom/Focus* and press **ENTER**.

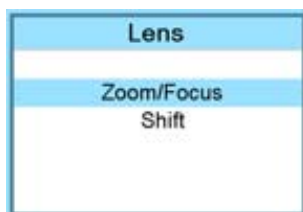

Image 12-7

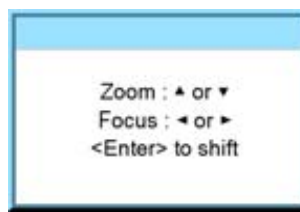

Image 12-8

2. Use the ▲ or ▼ key to zoom the lens.  
Use the ◀ or ▶ key to focus the lens.
3. Press **ENTER** to go to the shift adjustments.

### Lens shift

1. Use the ▲ or ▼ key to select *Shift* and press **ENTER** or when in the Zoom/Focus menu press **ENTER** to toggle to the Shift menu.



Image 12-9

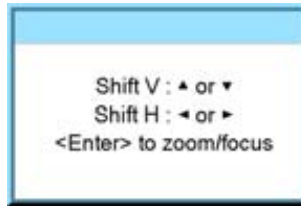

Image 12-10

- Use the ▲ or ▼ key to shift the lens upwards or downwards.  
Use the ◀ or ▶ key to shift the lens to the left or to the right.

## 12.4 Side keystone

### What can be done?

The side keystone adjustment is used to align the image if the projector is mounted at a non standard projection angle.

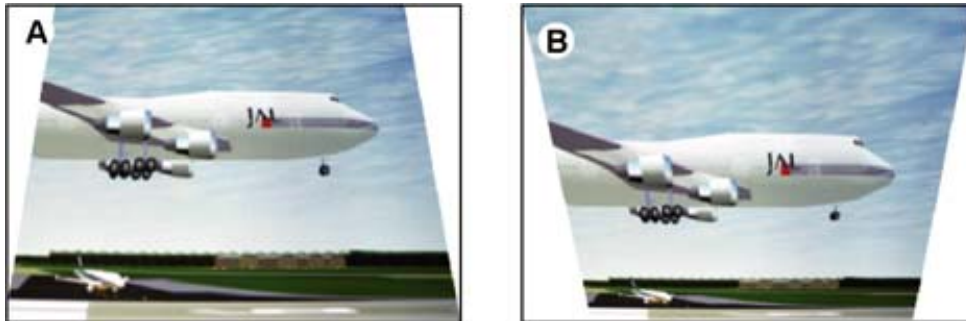

Image 12-11  
Side keystone

- A Keystone adjustment with positive values
- B Keystone adjustment with negative values

### Side keystone adjustment

- Press **MENU** to activate the menus.
- Use the ▲ or ▼ key to select *Alignment* and press **ENTER**.
- Use the ▲ or ▼ key to select *Side keystone* and press **ENTER**.

The keystone dialog box appears.

- Use the ◀ or ▶ key to adjust the keystone of the image.

When the upper part of the image is wider than the lower part of the image, push the ◀ key. The value below the bar scale will be negative.

When the upper part of the image is smaller than the lower part of the image, push the ▶ key. The value below the bar scale will be positive.

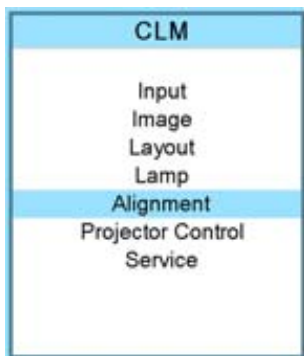

Image 12-12

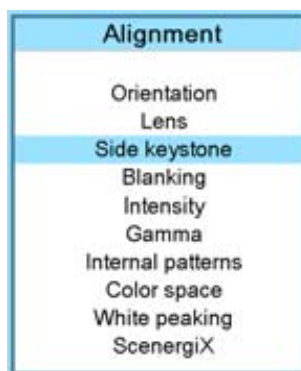

Image 12-13



Image 12-14

## 12.5 Blanking

### What can be done ?

Blanking adjustments affect only the edges of the projected image and are used to frame the projected image on to the screen and to hide or black out unwanted information (or noise). A '0' on the bar scale indicates no blanking.

### Which blanking adjustments are available ?

- top blanking
- bottom blanking
- left blanking
- right blanking

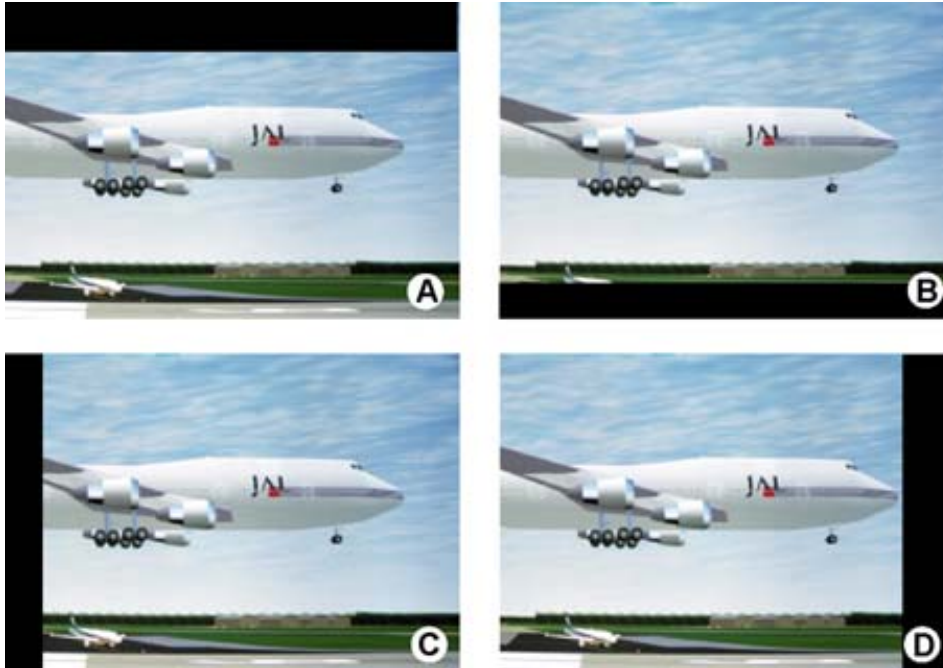

Image 12-15  
Blanking

- A Top blanking
- B Bottom blanking
- C Left blanking
- D Right blanking

The reset function brings all blanking settings back to zero.

### How to adjust the blanking?

1. Press **MENU** to activate the menus.
2. Use the **▲** or **▼** key to select *Alignment* and press **ENTER**.
3. Use the **▲** or **▼** key to select *Blanking* and press **ENTER**.
4. Use the **▲** or **▼** key to select the desired blanking adjustment and press **ENTER**.
5. Use the **▲** or **▼** key to adjust until the desired blanking is reached.
6. Press **EXIT** to return.

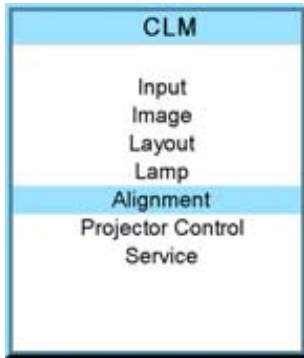

Image 12-16

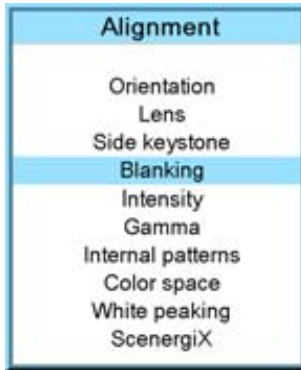

Image 12-17



Image 12-18

## 12.6 Intensity

### What can be done

The light in the optical light path can be dimmed with a mechanical shutter plate. This way of light dimming will enhance the contrast of the image. Optical light dimming can reduce the light more than the lamp power reduction and it will enhance the contrast at the same time. Both dimming methods can be combined.

Maximum intensity (255) has the same result as closing the shutter by pushing the projector in pause.

When set on 0 (zero): no dimming.

When set on 255 : maximum dimming.

### How to dim?

1. Press **MENU** to activate the menus.
2. Use the **▲** or **▼** key to select *Alignment* and press **ENTER**.
3. Use the **▲** or **▼** key to select *Optical dimming* and press **ENTER**.  
The Optical dimming progress bar appears.
4. Use **◀** or **▶** key to change the optical dimming setting and press **EXIT**.

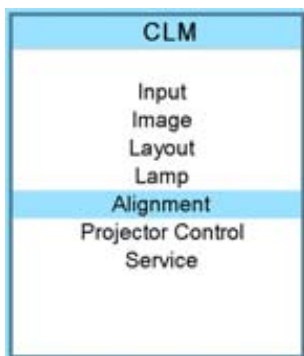

Image 12-19



Image 12-20

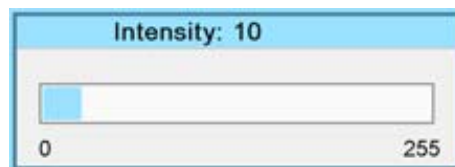

Image 12-21

## 12.7 Gamma

### About Gamma

Gamma is an image quality enhancement function that offers a richer image by brightening the already darker portions of the image without altering the brightness of the brighter portions (contrast feeling enhanced).

### How to adjust gamma?

1. Press **MENU** to activate the menus.
2. Use the **▲** or **▼** key to select *Alignment* and press **ENTER**.

- Use the ▲ or ▼ key to select *Gamma* and press **ENTER**.  
The Gamma progress bar appears.
- Use ◀ or ▶ key to change the gamma setting and press **EXIT**.  
Gamma can be set to one of the 8 available steps.

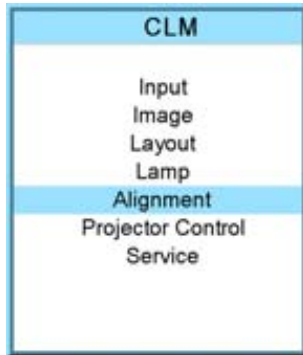

Image 12-22

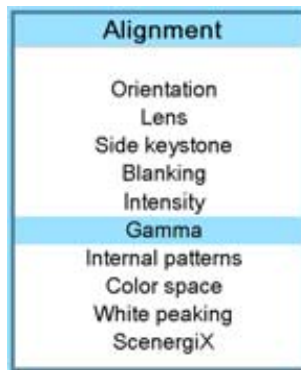

Image 12-23



Image 12-24

## 12.8 Internal pattern

### What can be done with these patterns?

The projector is equipped with different internal patterns which can be used for measurement and alignment purposes.

### How to select?

- Press **MENU** to activate the menus.
- Use the ▲ or ▼ key to select *Alignment* and press **ENTER**.
- Use the ▲ or ▼ key to select *Internal patterns* and press **ENTER**.  
The internal patterns menu is displayed.
- Use the ▲ or ▼ key to scroll through the possible selection and press **ENTER** to activate the selected pattern.  
Select ▲ or ▼ in the menu to display the previous or next page with possible internal patterns.

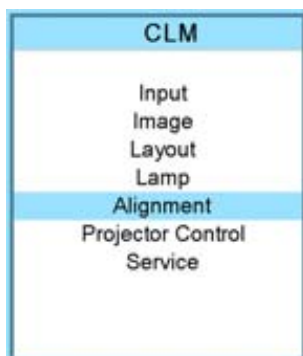

Image 12-25

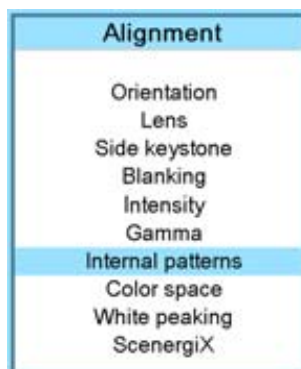

Image 12-26

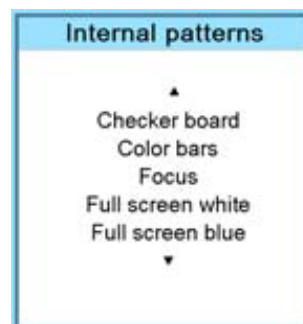

Image 12-27

The selected pattern is displayed.  
The following patterns are available:

- Checker board
- Color bars
- Focus
- Full screen black
- Full screen blue
- Full screen green
- Full screen red
- Full screen white
- Hatch
- Outline
- Purity
- ScenergiX

## 12.9 Color space



### Color space

A color space or color standard is a mathematical representation for a color. For example the RGB color space is based on a Cartesian coordinate system.

### What can be adjusted ?

The color space (gamut), the collection of colors which can be reproduced by the projector, can be adjusted to 4 predefined stored values (one projector specific, 2 international standards and one custom preset). A temporary custom adjustment is possible. The maximum color space which can be displayed is the projector color space. This color space is measured at the factory and stored inside the projector.

### How to select a color standard?

1. Press **MENU** to activate the menus.
2. Use the **▲** or **▼** key to select *Alignment* and press **ENTER**.
3. Use the **▲** or **▼** key to select *Color space* and press **ENTER**.
4. Use the **▲** or **▼** key to select the [On] or [Off] selection and **ENTER** to toggle color space on or off.
5. When color space is [On], use the **▲** or **▼** key to select the desired color standard and press **ENTER** to activate. Use the **▶** key to view the details or to edit the details when Custom is selected.

Projector	Maximum color space
EBU	European Broadcasting Union. This organization defines a European standard.
SMPTE	American standard.
Custom	The user can define the x and y coordinates for red, green and blue which forms the corners of the color space. By changing the coordinates, the color reproduction can be changed.

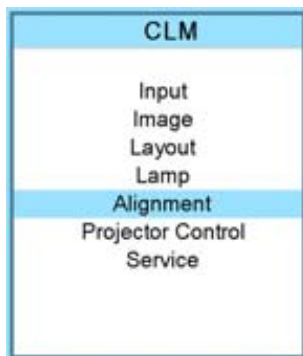

Image 12-28



Image 12-29

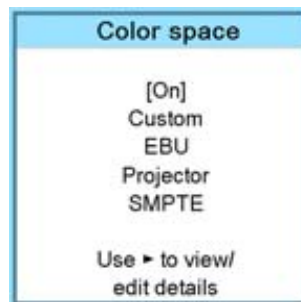

Image 12-30

6. When custom is selected, use the **▶** key to view the details. To adjust the custom values, select the desired color point using the **▲** or **▼** key and change the value with **◀** or **▶** key until the desired value is reached. When finished, press **EXIT** to return.

Color space 'custom' details	
Red x	0.638
Red y	0.351
Green x	0.370
Green y	0.597
Blue x	0.146
Blue y	0.054
White y	0.340
Use ◀ or ▶ to change a value	

Image 12-31



When selecting a fixed color space, the values of this selected color space overwrite the custom selected color space.

## 12.10 White peaking

### About white peak and brilliant color

In video centric applications true color reproduction is generally a priority over brightness. To achieve this a typical design will not utilize a white segment of the color wheel. This has the side effect of reducing the amount of light allowed through the color wheel, which reduces the overall brightness. To compensate for this a technique can be applied called Spoke Light Capture (SLR). The spokes are defined to be the time between colors. If the light is passed through the spokes, the average over time across them is made up of a mixture of the two adjacent colors. This will result in a secondary color. Color processing can take advantage of this situation. Combining red with green yields yellow light. Similarly, combining red with blue yields magenta while combining blue with green yields cyan. The BrilliantColor™ technology is configured to process the spoke regions as a secondary color which improves the brightness of the display and gives the viewer a truly life-like image.

If after all, the viewer is still not satisfied with the color reproduction, this can further be improved by diminishing the white peaking. With the white peaking on 10 the full white segment is used in projecting the image. At the other end when the white peaking is on 0, the white segment is cancelled out from the projected image. This makes the colors look more pronounced as with full white peaking on.

### How to change the white peaking value

1. Press **MENU** to activate the menus.
2. Use the **▲** or **▼** key to select *Alignment* and press **ENTER**.
3. Use the **▲** or **▼** key to select *White peaking* and press **ENTER**.
4. Use **◀** or **▶** key to change the white peaking setting and press **EXIT**.  
White peaking can be set between 0 and 10.

The default value is 10.

With 0, no white peaking, spokes not used to enhance the secondary colors and 10, full white peaking, spokes are fully used to enhance the secondary colors to show a truly life-like image.

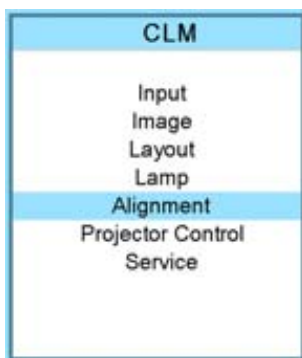

Image 12-32



Image 12-33

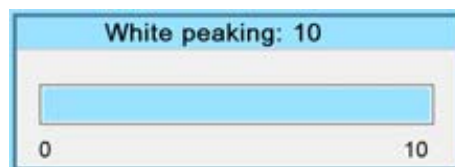

Image 12-34

## 12.11 ScenergiX

### Overview

- Introduction
- Preparations
- ScenergiX activation
- ScenergiX pattern
- ScenergiX overlap zone (horizontal ScenergiX)
- ScenergiX overlap zone (vertical ScenergiX)
- ScenergiX size adjustment (White level)
- Adjusting the black level of the images

### 12.11.1 Introduction

#### Why ScenergiX ?

When working in a multichannel setup the CLM HD8 and its Soft Edge possibilities enable an image blending that gives the appearance of a single view, thus achieving realistic immersion for the majority of wide screen applications.

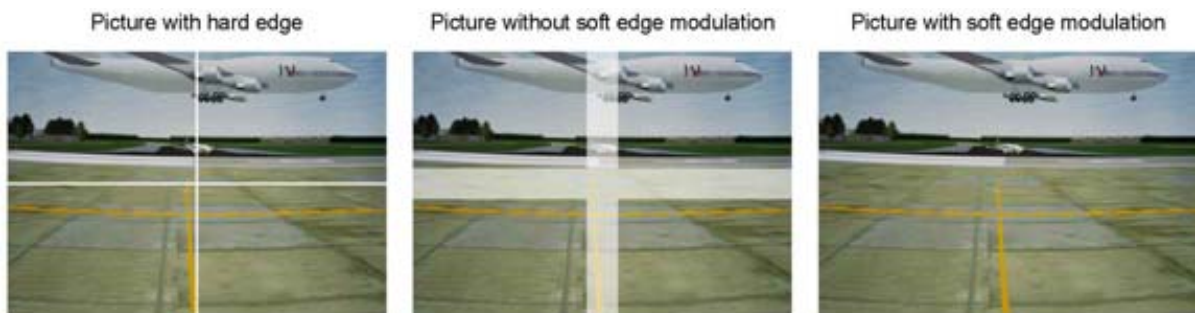

Image 12-35  
Why Soft Edge?

#### What is the Basic Principal of ScenergiX ?

The principle of edge blending is achieved by linear modulation of the light output in the overlap zone so that the light output in that zone equals the light output of the rest of the image.

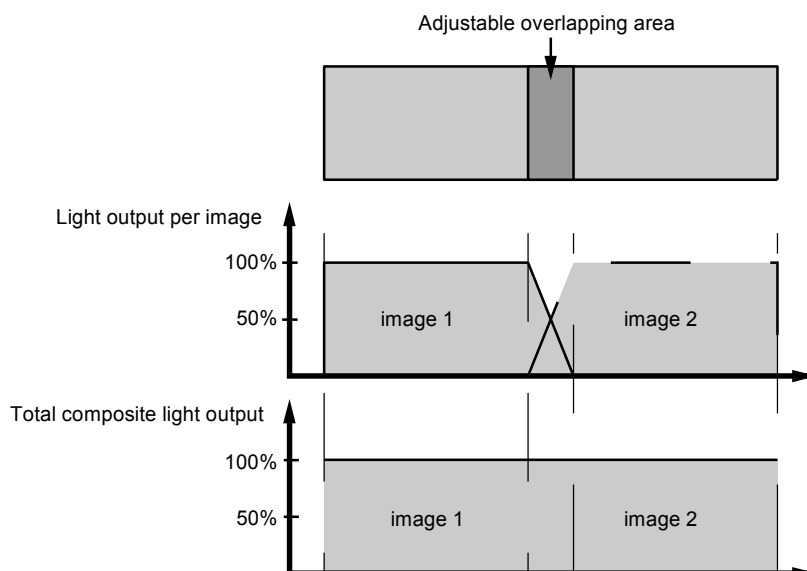

Image 12-36  
ScenergiX Basic Principle



## 12.11.2 Preparations

### ScenergiX Preparations

To ensure proper ScenergiX adjustment, be sure that the following adjustments are done perfectly on all projectors:

- Convergence
- Geometry
- Color Matching (Color Temperature, Color Standard, Input Balance, Gamma)

## 12.11.3 ScenergiX activation

### How to activate?

1. Press **MENU** to activate the menus.
2. Use the **▲** or **▼** key to select *Alignment* and press **ENTER**.
3. Use the **▲** or **▼** key to select *ScenergiX* and press **ENTER**.
4. Use the **▲** or **▼** key to select *Status* and press **ENTER** to toggle between [On] and [Off].

- On        ScenergiX is active  
Off        ScenergiX is not active

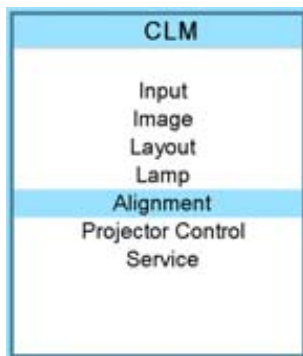

Image 12-37



Image 12-38

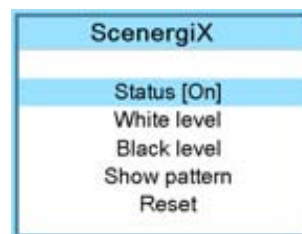

Image 12-39

## 12.11.4 ScenergiX pattern

### What can be done?

To make the ScenergiX adjustment more easy, an internal pattern can be displayed.

### How to display or remove the pattern?

1. Use the **▲** or **▼** key to select *Show pattern* and press **ENTER**.

The internal ScenergiX pattern is displayed.

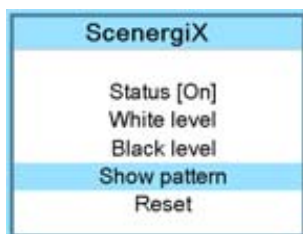
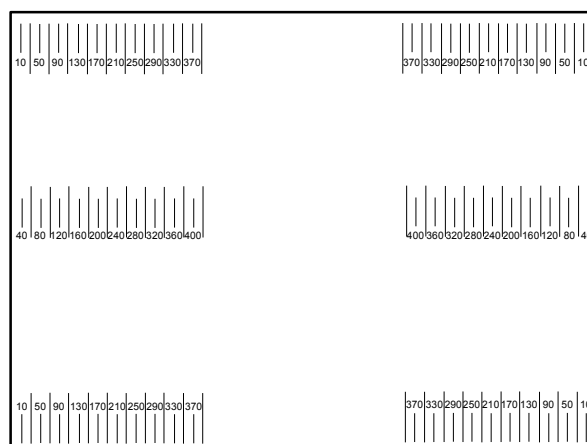

Image 12-40

Image 12-41  
ScenergiX pattern

## 12. Alignment menu

- To remove the internal pattern, use the ▲ or ▼ key to select *Hide pattern* and press **ENTER**.

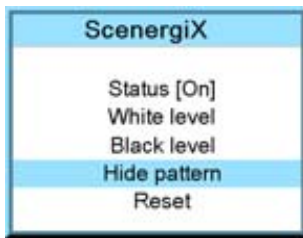

Image 12-42

### 12.11.5 ScenergiX overlap zone (horizontal ScenergiX)

#### Definitions

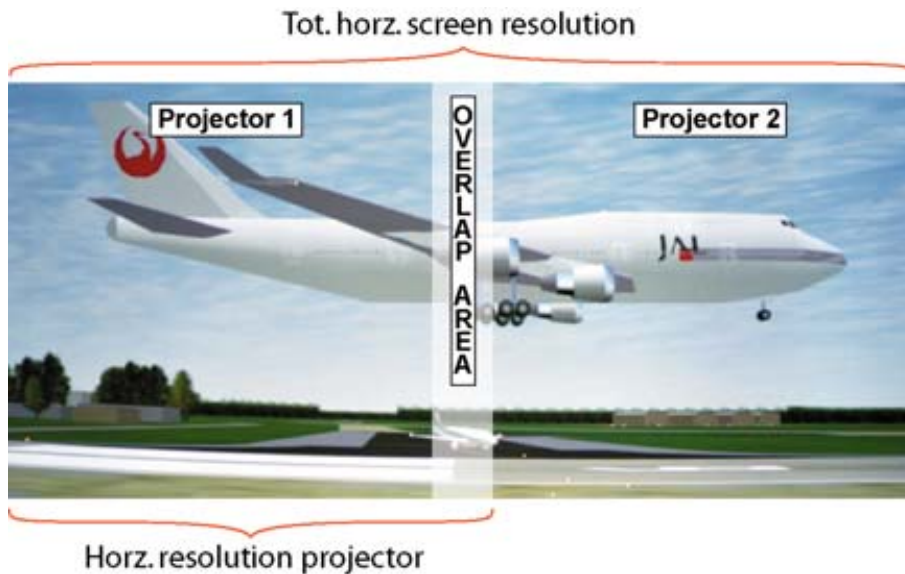

Image 12-43  
ScenergiX set up

Overlap : number of pixels that overlap

Horizontal resolution of 1 projector

Total horizontal screen resolution : [(horizontal resolution of 1 projector) x 2] minus overlap.

Horizontal Resolution source : number of active pixels of the source.

#### How to set for the first projector

- Go to *Layout* → *Main window* → *Size*
- Enter the value for the Width as follow: Total horizontal screen resolution / 2 - 0.5 x overlap zone.
- Position remains the same.

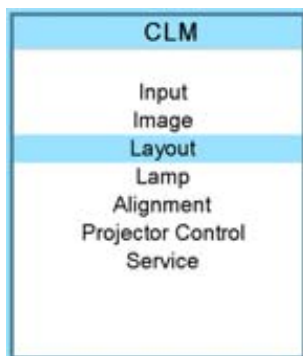

Image 12-44

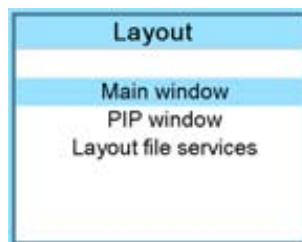

Image 12-45

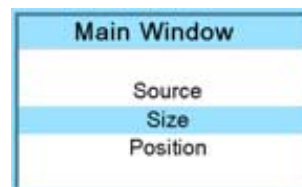

Image 12-46

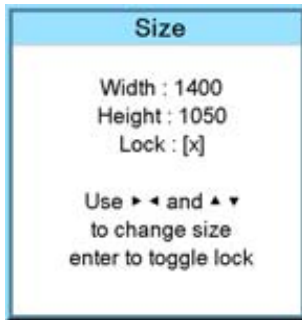

Image 12-47

### How to set for the second projector

1. Go to *Layout* → *Main window* → *Size*
2. Enter the value for the Width as follow: Total horizontal screen resolution / 2 - 0.5 x overlap zone.
3. Position = original start + horizontal width of projector 1 - overlap zone

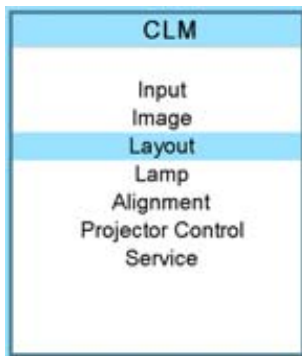

Image 12-48

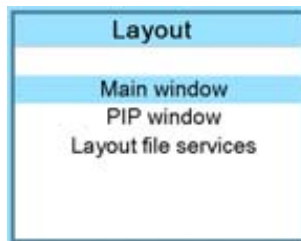

Image 12-49

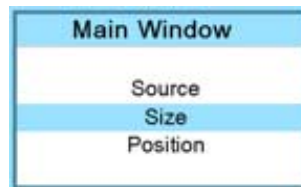

Image 12-50

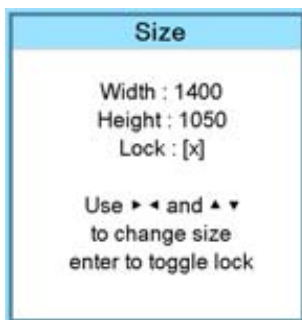

Image 12-51



Image 12-52

### 12.11.6 ScenergiX overlap zone (vertical ScenergiX)

#### Definitions

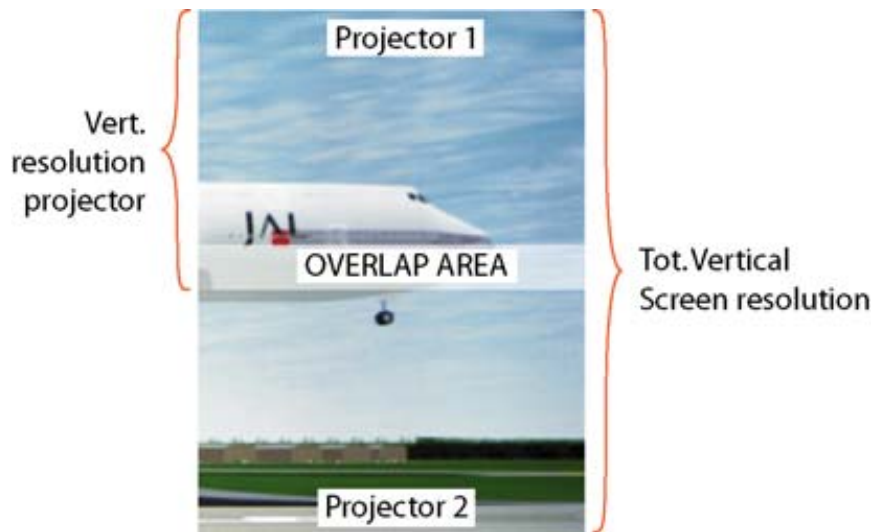

Image 12-53  
ScenergiX overlap zone vertical

Overlap : number of pixels that overlap

Vertical resolution of 1 projector

Total vertical screen resolution : [(Vertical resolution of 1 projector) x 2] minus (overlap)

Vertical Resolution source : number of active lines of the source

#### How to set for the first projector

1. Go to *Layout* → *Main window* → *Size*
2. Enter the value for the Height as follow: Total Vertical screen resolution / 2 - 0.5 x overlap zone.
3. Position remains the same.

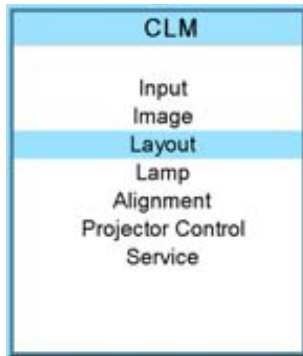

Image 12-54

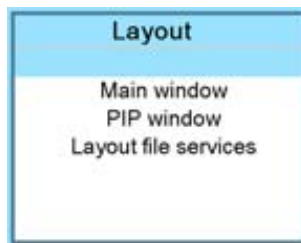

Image 12-55

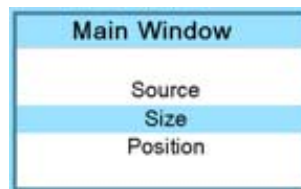

Image 12-56

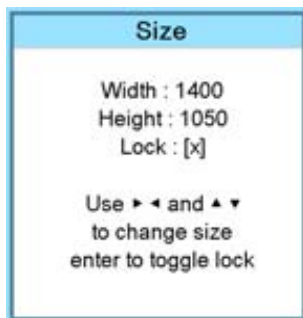

Image 12-57

### How to set for the second projector

1. Go to *Layout* → *Main window* → *Size*
2. Enter the value for the Width as follow: Total Vertical screen resolution / 2 - 0.5 x overlap zone.
3. Position = original start + Vertical height projector 1 - overlap zone

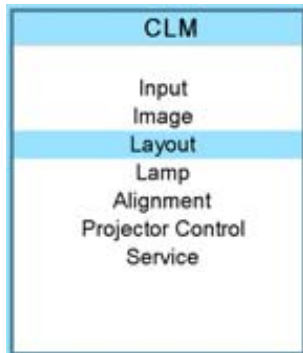

Image 12-58

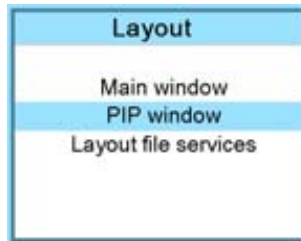

Image 12-59

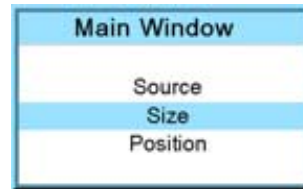

Image 12-60

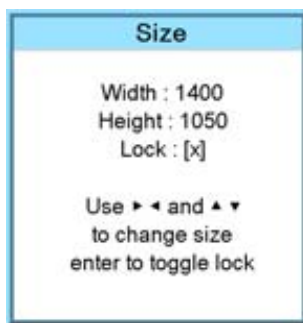

Image 12-61

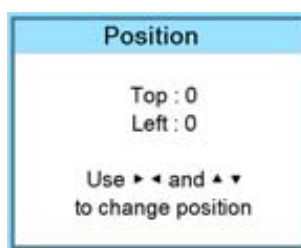

Image 12-62

#### 12.11.7 ScenergiX size adjustment (White level)

##### What can be done with the white level menu?

The white level menu contains top, bottom, left or right item to set the blending zone.



The ScenergiX menu items are only accessible when status is [On].

##### How to set the blending zone?

1. Press **MENU** to activate the menus.
2. Use the **▲** or **▼** key to select *Alignment* and press **ENTER**.
3. Use the **▲** or **▼** key to select *ScenergiX* and press **ENTER**.
4. Use the **▲** or **▼** key to select *White level* and press **ENTER**.
5. Use the **▲** or **▼** key to select one of the four size adjustments and press **ENTER**.

12. Alignment menu

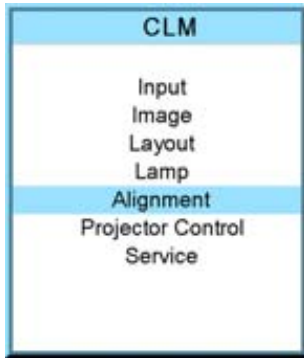

Image 12-63



Image 12-64

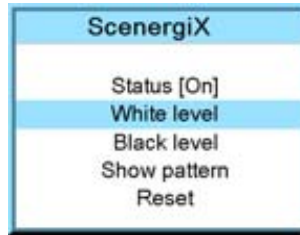

Image 12-65



Image 12-66

A pattern with the different areas is displayed.

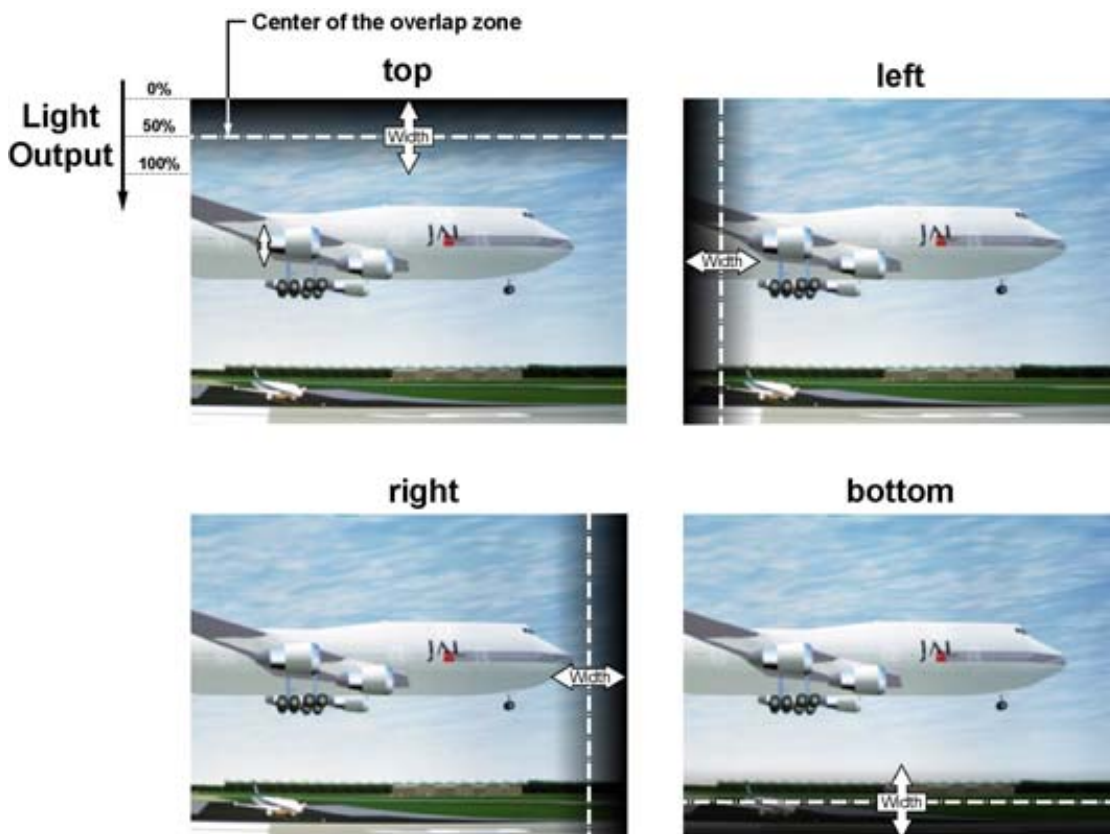

Image 12-67  
Width selections

- Use the cursor keys to move the border of the overlap area to the desired position. Set first the width for the first projector and repeat for the second one.

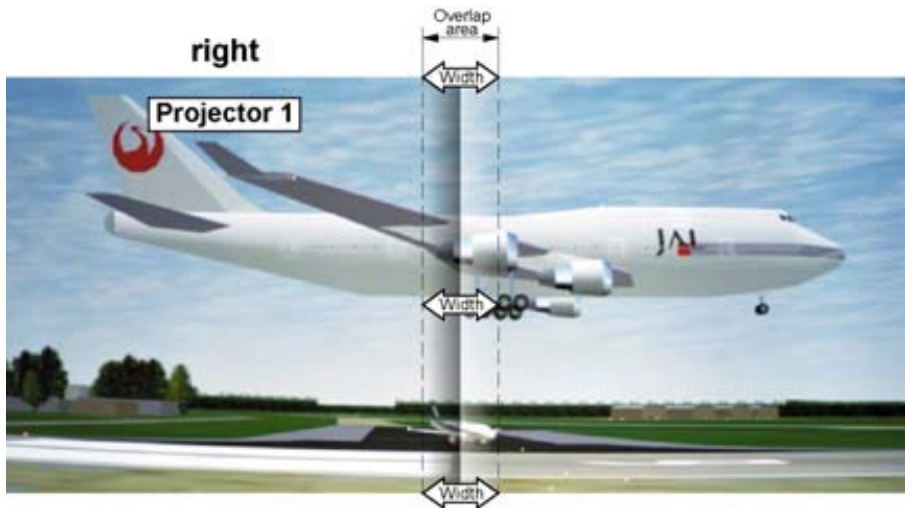

Image 12-68  
Width set up for projector 1

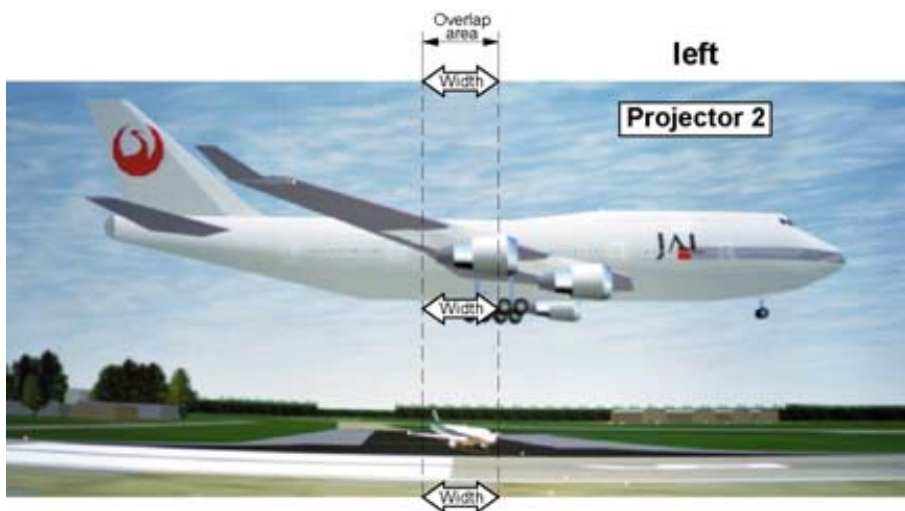

Image 12-69  
Width set up for projector 2

### 12.11.8 Adjusting the black level of the images

#### Why black level adjustment

For dark images, the overlap zone will be brighter than the rest of the images. Typically for DLP projectors, next to the overlap zone, a brighter area is recognized. This area is known as a DLP leakage area. This area must also be excluded for the black level adjustment. Therefore we can raise the black level of the remaining image (excluding the overlap zone and the DLP leakage area).

First, the width of the leakage area must be set. The white cursor line indicates the border of the overlap area. The green cursor line indicates the current installed DLP leakage area border and starts at the position of the white cursor line (no width installed). This green line can be moved to the border of the DLP leakage area with the cursor keys.

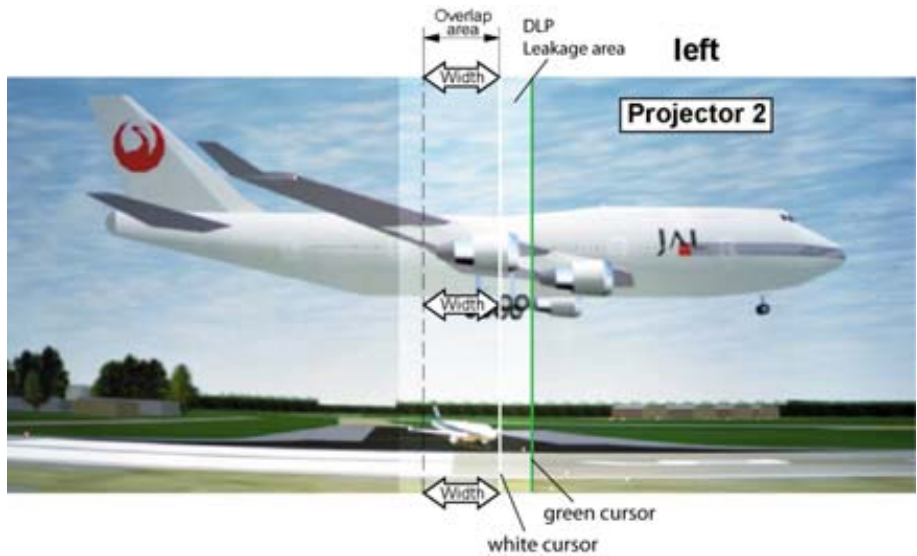

Image 12-70  
DLP Leakage area set up



After the area is set, use **TEXT** key to remove the area border lines when adjusting the black level.

### How to set the leakage area width

1. Press **MENU** to activate the menus.
2. Use the **▲** or **▼** key to select *Alignment* and press **ENTER**.
3. Use the **▲** or **▼** key to select *ScenergiX* and press **ENTER**.
4. Use the **▲** or **▼** key to select *Black level* and press **ENTER**.
5. Use the **▲** or **▼** key to select one of the four size adjustments and press **ENTER**.

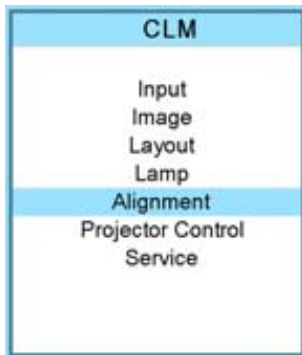

Image 12-71

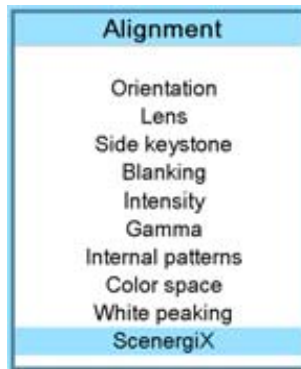

Image 12-72

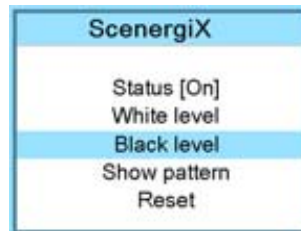
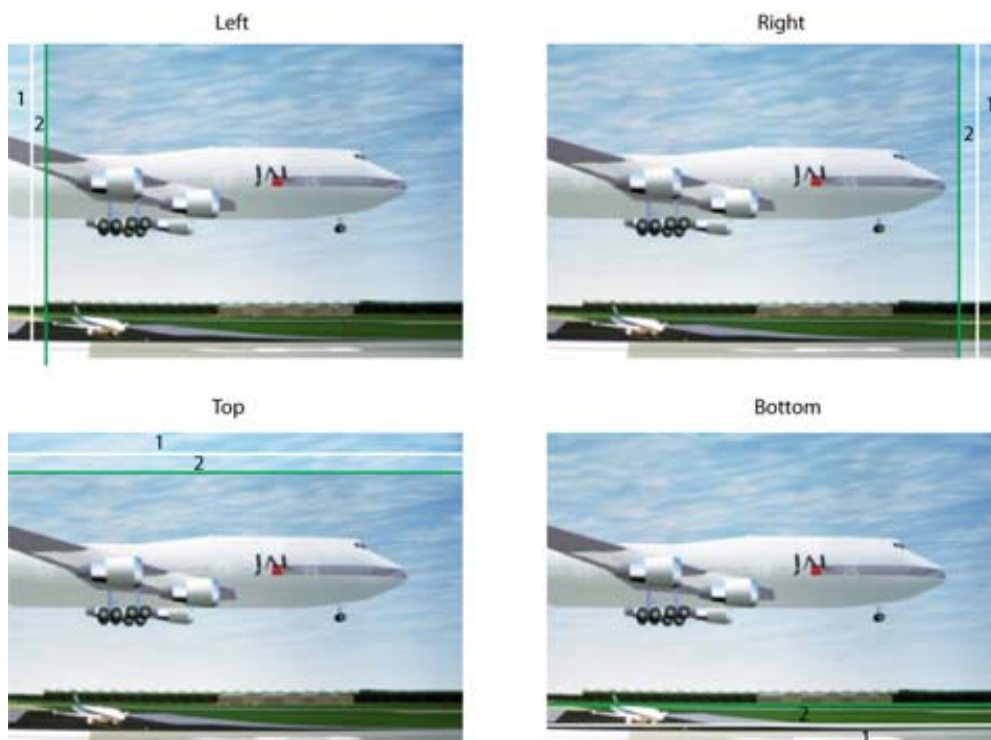

Image 12-73



Black level	
	Select Area
Top	31
Bottom :	0
Left :	0
Right :	0
	Adjust
All	< >
Red	<20>
Green	<20>
Blue	<20>

Image 12-74

Image 12-75  
DLP leakage area

- 1 Overlap area
- 2 DLP Leakage area

6. Use the cursor keys to move the green border line to the desired position.

The leakage area for this overlap is defined and will be excluded during black level adjustment.

### How to adjust

1. Press **MENU** to activate the menus.
2. Use the **▲** or **▼** key to select *Alignment* and press **ENTER**.
3. Use the **▲** or **▼** key to select *ScenergiX* and press **ENTER**.
4. Use the **▲** or **▼** key to select *Black level* and press **ENTER**.

12. Alignment menu

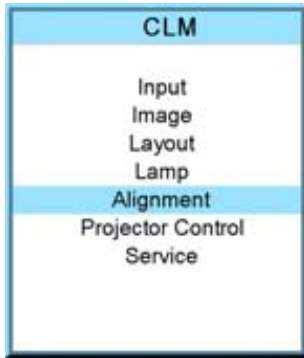

Image 12-76



Image 12-77

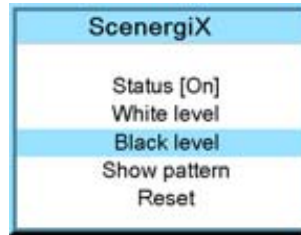

Image 12-78



Image 12-79

- Adjust the black level of area A until the black level of area A, B and C are equal. Use the Adjust function All, Red, Green and Blue in the Black level menu.

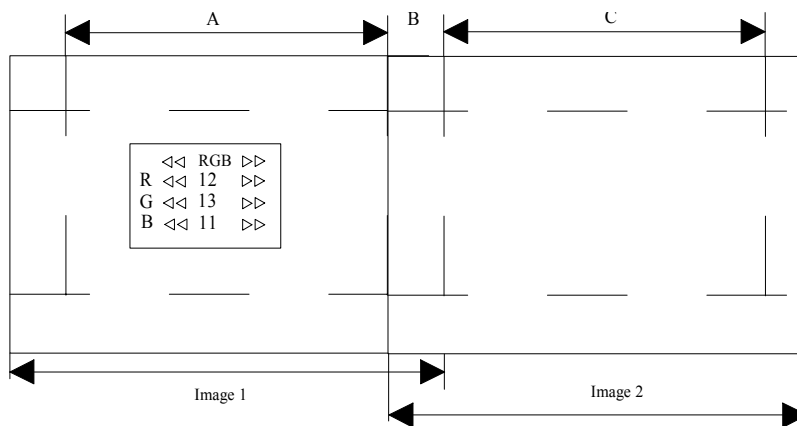

Image 12-80  
Black level adjustment



Use the **Reset** function to bring all ScenergiX settings back to zero.

# 13. PROJECTOR CONTROL

## About this chapter

This chapter explains the setup of the control part of the software such as projector address and all types of communication with the external world.

## Overview

- Overview flow
- Projector address
- Serial communication
- Network
- IR control switching
- DMX
- Buttons
- Menu position
- Local LCD contrast
- Language selection

## 13.1 Overview flow

### Overview

Level 1	Level 2	Level 3
Projector control	Projector address	Projector address Common address
	Serial communication	Baud rate [115200] Interface standard [RS232/RS422] RS422 termination [Off/On]
	Network	DHCP [ON/OFF] IP-address Subnet mask Default gateway
	IR control	IR Front [On/Off] IR Back [On/Off] IR Side [On/Off]
	DMX	DMX address DMX universe DMX monitor DMX mode
	Buttons	APA [auto image menu] Shortcut keys
	Menu position	

Level 1	Level 2	Level 3
		Menu [Center]
		Bar scale [Bottom]
	Local LCD contrast	
	Language	
		English
		Français
		Deutsch
		Español
		Italiano

## 13.2 Projector address

### Overview

- Individual projector address
- Common address

### 13.2.1 Individual projector address

#### About individual projector address

Before a projector, and only this projector, can be controlled via a remote control, an individual address must be entered in the projector.

This individual projector address can then be used to control the projector via remote control or via a serial connection.

Next to an individual projector address, each projector has also a common address for group control.

#### How to set an individual address?

1. Press **MENU** to activate the menus.
2. Use the **▲** or **▼** key to select *Projector control* and press **ENTER**.
3. Use the **▲** or **▼** key to select *Projector address* and press **ENTER**.
4. Use the **▲** or **▼** key to select *Projector Address* and press **ENTER**.  
The edit projector address window opens.
5. Use the **▲** or **▼** key to select a new value  
Or,  
enter a new value with the digit keys on the remote control or local keypad.
6. Use the **◀** or **▶** key to select the next digit and repeat step 5.
7. When the desired address is entered, press **ENTER** to store that address.

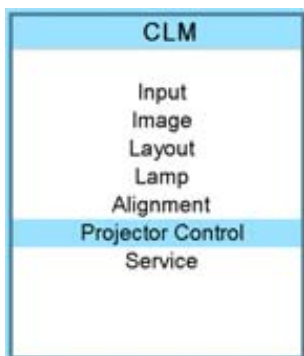

Image 13-1



Image 13-2

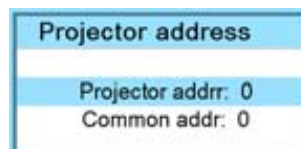

Image 13-3

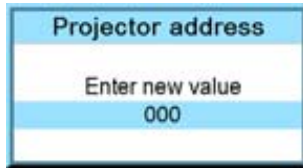

Image 13-4

### 13.2.2 Common address

#### About common address

A common address can be '0' or '1'.

Any command coming from a remote control programmed with that common address will be executed.

#### How to change the common address?

1. Press **MENU** to activate the menus.
2. Use the **▲** or **▼** key to select *Projector control* and press **ENTER**.
3. Use the **▲** or **▼** key to select *Projector address* and press **ENTER**.
4. Use the **▲** or **▼** key to select *Common address* and press **ENTER**.

The edit common address window opens.

5. Use the **▲** or **▼** key to select '0' or '1'  
Or,  
enter '0' or '1' with the digit keys on the remote control or local keypad.
6. When the desired address is entered, press **ENTER** to store that address.

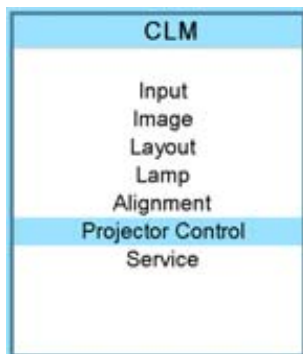

Image 13-5

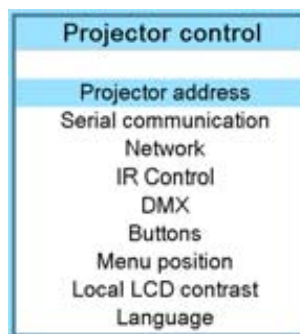

Image 13-6

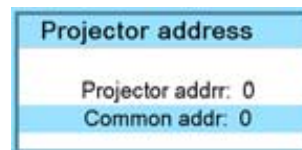

Image 13-7

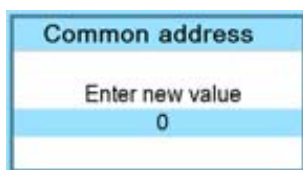

Image 13-8

## 13.3 Serial communication

### Overview

- Baud rate setup
- Interface standard
- RS422 termination

### 13.3.1 Baud rate setup

#### What can be done?

The baudrate for a serial connection with a computer can be set up.

#### How to set up?

1. Press **MENU** to activate the menus.
2. Use the ▲ or ▼ key to select *Projector control* and press **ENTER**.
3. Use the ▲ or ▼ key to select *Serial communication* and press **ENTER**.

The serial communication menu opens.

4. Use the ▲ or ▼ key to select *Baudrate* and press **ENTER** to toggle between the available baud rates.  
The following baud rates can be selected:
  - 9600
  - 19200
  - 38400
  - 57600
  - 115200
5. Press **EXIT** to return.

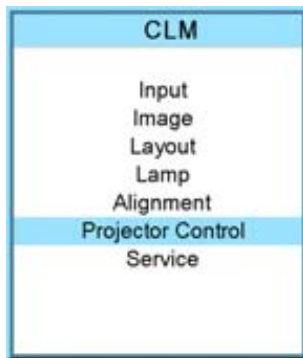

Image 13-9

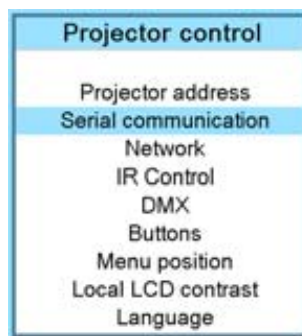

Image 13-10

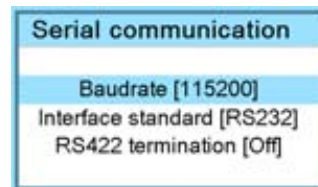

Image 13-11

### 13.3.2 Interface standard

#### What can be done?

The communication protocol for the communication between the projector and a computer can be set to RS232 or RS422.

#### How to set up

1. Press **MENU** to activate the menus.
2. Use the ▲ or ▼ key to select *Projector control* and press **ENTER**.
3. Use the ▲ or ▼ key to select *Serial communication* and press **ENTER**.

The serial communication menu opens.

4. Use the ▲ or ▼ key to select *Interface standard* and press **ENTER** to toggle between [RS232] or [RS422].  
Default: [RS232]

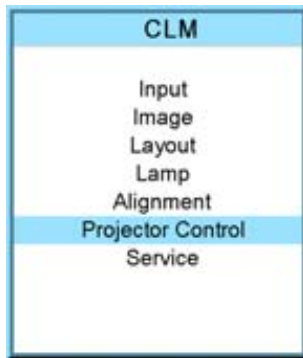

Image 13-12



Image 13-13

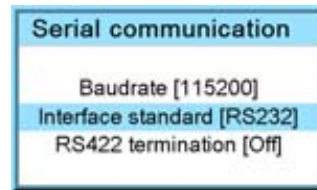

Image 13-14

### 13.3.3 RS422 termination

#### What can be done?

When the interface standard is set to RS422, the last projector in a line should be RS422 terminated (ON position). All others in the line should be in the OFF position.

#### How to set

1. Press **MENU** to activate the menus.
2. Use the **▲** or **▼** key to select *Projector control* and press **ENTER**.
3. Use the **▲** or **▼** key to select *Serial communication* and press **ENTER**.

The serial communication menu opens.

4. Use the **▲** or **▼** key to select *RS422 termination* and press **ENTER** to toggle between [On] or [Off].

Default: [On]

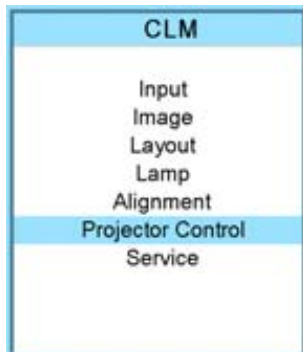

Image 13-15

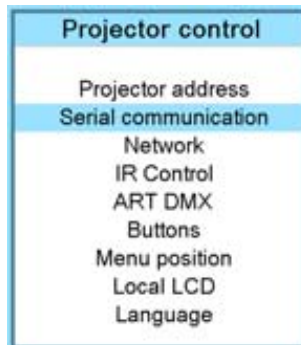

Image 13-16

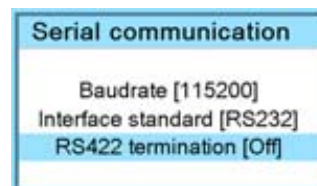

Image 13-17

## 13.4 Network

### Overview

- Introduction to a Network connection
- DHCP setup
- IP-address set up
- Subnet-mask set up
- Default Gateway set up

### 13.4.1 Introduction to a Network connection

---



#### DHCP

Dynamic host configuration protocol. DHCP is a communications protocol that lets network administrators manage centrally and automate the assignment of IP addresses in an organization's network. Using the Internet Protocol, each machine that can connect to the Internet needs a unique IP address. When an organization sets up its computer users with a connection to the Internet, an IP address must be assigned to each machine. Without DHCP, the IP address must be entered manually at each computer and, if computers move to another location in another part of the network, a new IP address must be entered. DHCP lets a network administrator supervise and distribute IP addresses from a central point and automatically sends a new IP address when a computer is plugged into a different place in the network.

---



#### IP

Internet Protocol. The network layer of TCP/IP. Required for communication with the internet.

---



#### Subnet mask

A number that is used to identify a subnetwork so that IP addresses can be shared on a local area network.

---



#### Default Gateway

A router that serves as an entry point into and exit point out of a network. For example, a local network (LAN) may need a gateway to connect it to a wide area network (WAN) or to the Internet.

---



#### MAC address

Media Access Control address. Unique hardware number, used in combination with the IP-address to connect to the network (LAN or WAN).

---

### What should be set up for an Ethernet address?

2 ways can be used to assign an address:

- use the DHCP setting so that an automatic address will be assigned.
- Assign manually an IP address, Net-mask (subnet-mask), (default) gateway address.
  - Set the IP-Address field to the desired value. This must NOT be 0.0.0.0 for static IP-Address assignment. The IP address identifies a projector's location on the network in the same way a street address identifies a house on a city block. Just as a street address must identify a unique residence, an IP address must be globally unique and have a uniform format.
  - Set the Subnet-Mask as appropriate for the local subnet.
  - Set the Default-Gateway to the IP-Address of the local router (MUST be on the local subnet!) on the same network as this projector that is used to forward traffic to destinations beyond the local network. This must not be 0.0.0.0. If there is no router on the projector's local subnet then just set this field to any IP-Address on the subnet.

### 13.4.2 DHCP setup

#### How to switch DHCP setting?

1. Press **MENU** to activate the menus.
2. Use the **▲** or **▼** key to select *Projector control* and press **ENTER**.
3. Use the **▲** or **▼** key to select *Ethernet* and press **ENTER**.

The Ethernet menu opens.

4. Use the **▲** or **▼** key to select *DHCP*.
5. Press **ENTER** to toggle the DHCP setting.



[ON] = DHCP is activated. Automatic assigning of an address is activated.

[OFF ] = DHCP is deactivated. A fixed address will be used.

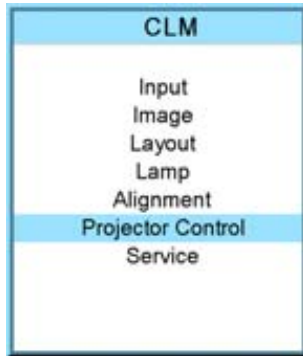

Image 13-18

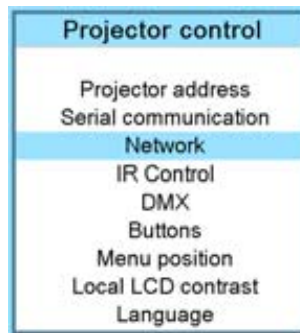

Image 13-19

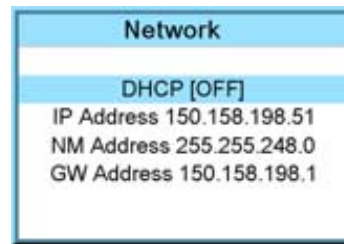

Image 13-20

### 13.4.3 IP-address set up

#### How to set up?

1. Press **MENU** to activate the menus.
2. Use the **▲** or **▼** key to select *Projector control* and press **ENTER**.
3. Use the **▲** or **▼** key to select *Network* and press **ENTER**.  
The Network menu opens.
4. Use the **▲** or **▼** key to select *IP-address* and press **ENTER** to select.  
**Note:** An address contains 4 octets with a maximum value of 255.  
*This must NOT be 0.0.0.0 for static IP-Address assignment.*
5. Use the **▲** or **▼** key to select the desired digit and press **◀** or **▶** key to select the next digit in the address.  
Or,  
enter the value with the digit keys on the remote control or local keypad. The next digit in the address will be selected automatically.
6. Press **EXIT** to return.

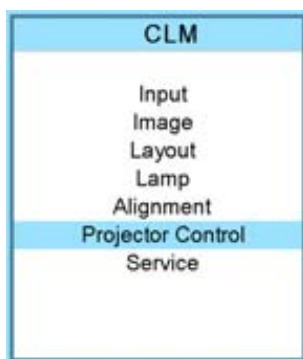

Image 13-21

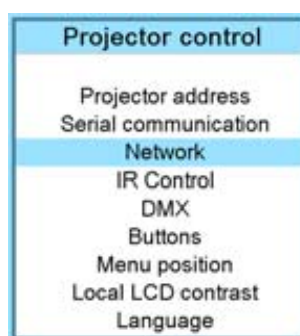

Image 13-22

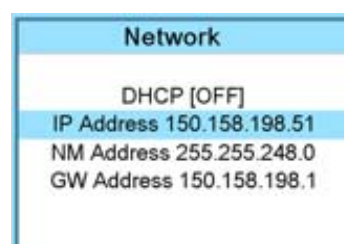

Image 13-23

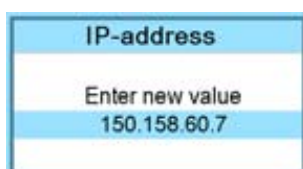

Image 13-24

### 13.4.4 Subnet-mask set up

#### How to set up?

1. Press **MENU** to activate the menus.

## 13. Projector control

2. Use the ▲ or ▼ key to select *Projector control* and press **ENTER**.
3. Use the ▲ or ▼ key to select *Network* and press **ENTER**.

The Ethernet menu opens.

4. Use the ▲ or ▼ key to select *Subnet mask* and press **ENTER** to select.  
**Note:** An address contains 4 octets with a maximum value of 255.

Fill out the 4 fields as appropriate for the local subnet.

5. Use the ▲ or ▼ key to select the desired digit and press ◀ or ▶ key to select the next digit in the address.  
Or,  
enter the value with the digit keys on the remote control or local keypad. The next digit in the address will be selected automatically.
6. Press **EXIT** to return.

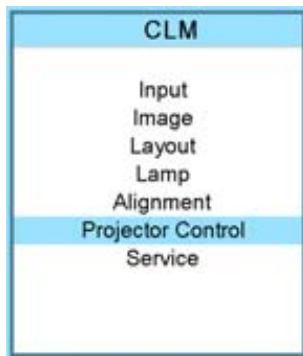

Image 13-25

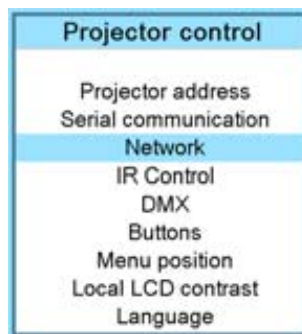

Image 13-26

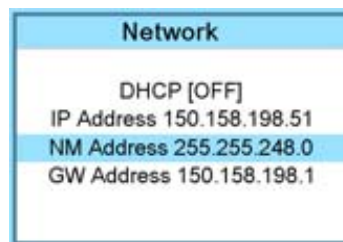

Image 13-27

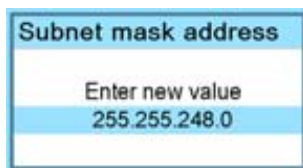

Image 13-28

### 13.4.5 Default Gateway set up

#### How to set up?

1. Press **MENU** to activate the menus.
2. Use the ▲ or ▼ key to select *Projector control* and press **ENTER**.
3. Use the ▲ or ▼ key to select *Network* and press **ENTER**.

The Ethernet menu opens.

4. Use the ▲ or ▼ key to select *Default Gateway* and press **ENTER** to select.  
**Note:** An address contains 4 octets with a maximum value of 255.

Set the default gateway to the IP-address of the router (MUST be on the local subnet!). If there is no router on the projector's local subnet then just set this field to any IP-address on the subnet.

5. Use the ▲ or ▼ key to select the desired digit and press ◀ or ▶ key to select the next digit in the address.  
Or,  
enter the value with the digit keys on the remote control or local keypad. The next digit in the address will be selected automatically.  
**Note:** This must NOT be 0.0.0.0

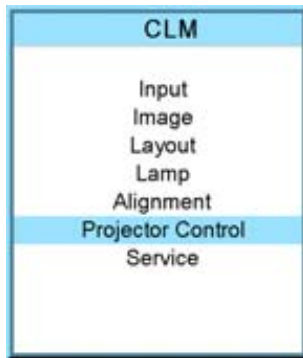

Image 13-29



Image 13-30

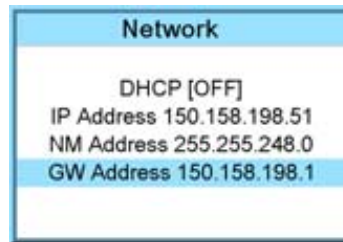

Image 13-31

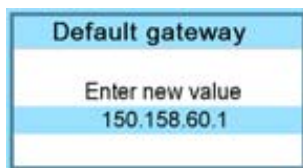

Image 13-32

6. Press **EXIT** to return.

## 13.5 IR control switching

### What can be done?

Each IR receiver inside the projector can be activated or deactivated. When an IR receiver is deactivated, no IR signal send to this IR receiver will be processed. When entering an Activation code with the remote control all IR receivers can be activated at the same time.

### How to switch

1. Press **MENU** to activate the menus.
2. Use the **▲** or **▼** key to select *Projector control* and press **ENTER**.
3. Use the **▲** or **▼** key to select *IR Control* and press **ENTER**.
4. Use the **▲** or **▼** key to select the desired IR receiver and press **ENTER** to toggle this receiver [on] or [off].

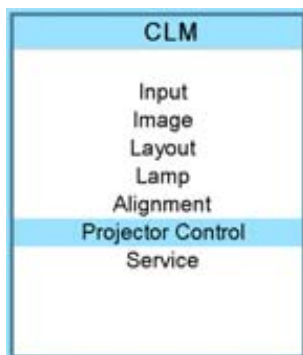

Image 13-33



Image 13-34

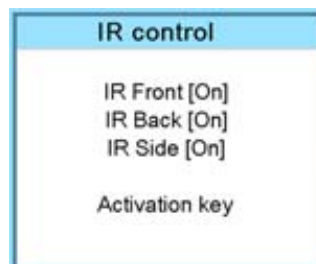

Image 13-35

### Activation key

1. Use the **▲** or **▼** key to select *Activation key* and press **ENTER**.  
The Activation key window opens. The first digit is selected.
2. Enter a new value with the digit buttons. The next digit is selected. Or use **◀** or **▶** key to select another digit.
3. Press **ENTER** to activate the key.



Image 13-36

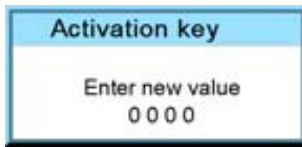

Image 13-37

## 13.6 DMX

### Overview

- DMX address
- DMX universe
- DMX monitor
- DMX mode
- Art-Net Activation



While the local LCD display on the CLM is active (backlight is on), the DMX response time may increase.

### 13.6.1 DMX address

#### How to set the DMX address

1. Press **MENU** to activate the menus.
2. Use the **▲** or **▼** key to select *Projector control* and press **ENTER**.
3. Use the **▲** or **▼** key to select *DMX* and press **ENTER**.
4. Use the **▲** or **▼** key to select *DMX address* and press **ENTER**.  
The edit DMX address window opens.
5. Use the **▲** or **▼** key to select a new value  
Or,  
enter a new value with the digit keys on the remote control or local keypad.
6. Use the **◀** or **▶** key to select the next digit and repeat step 5.
7. When the desired address is entered, press **ENTER** to store that address.

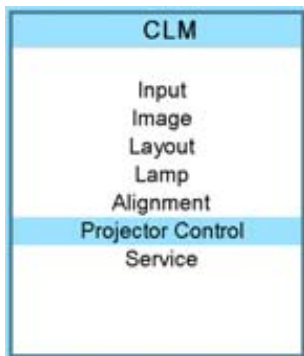

Image 13-38



Image 13-39

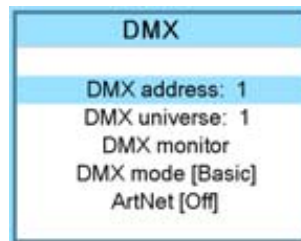

Image 13-40



Image 13-41

### 13.6.2 DMX universe

#### About DMX universe

One DMX universe can contain a limited number of projectors depending on the DMX mode. Only 512 channels can be connected to one universe. When the number of channels exceed the universe space, a new universe has to be created

#### How to set the DMX universe

1. Press **MENU** to activate the menus.
2. Use the ▲ or ▼ key to select *Projector control* and press **ENTER**.
3. Use the ▲ or ▼ key to select *DMX* and press **ENTER**.
4. Use the ▲ or ▼ key to select *DMX universe* and press **ENTER**.  
The edit DMX universe window opens.
5. Use the ▲ or ▼ key to select a new value  
Or,  
enter a new value with the digit keys on the remote control or local keypad.
6. Use the ◀ or ▶ key to select the next digit and repeat step 5.
7. When the desired universe is entered, press **ENTER** to store that universe.

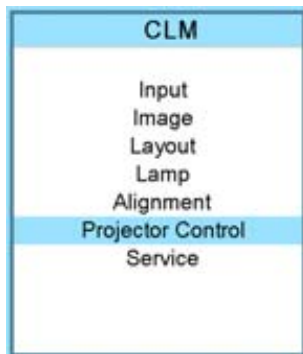

Image 13-42

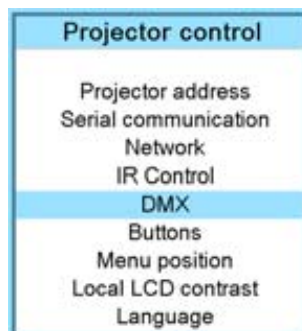

Image 13-43

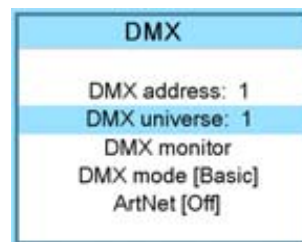

Image 13-44

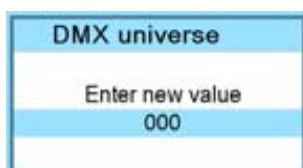

Image 13-45

### 13.6.3 DMX monitor

#### What can be done?

If a DMX device is connected, the settings per channel can be displayed in an on screen menu.

#### How to start up the monitoring

1. Press **MENU** to activate the menus.
2. Use the ▲ or ▼ key to select *Projector control* and press **ENTER**.
3. Use the ▲ or ▼ key to select *DMX* and press **ENTER**.
4. Use the ▲ or ▼ key to select *DMX monitor* and press **ENTER**.

### 13. Projector control

The *DMX monitor* window opens. Depending on the DMX mode, the *Normal* view or the *Simple* view of the DMX monitor window opens.

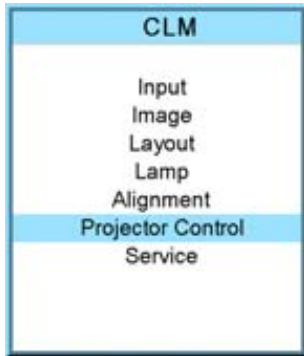

Image 13-46

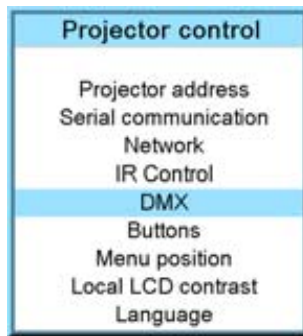

Image 13-47

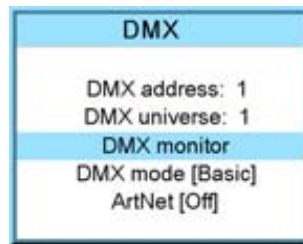

Image 13-48

DMX Monitor		
Channel	Function	Parameter
1	Intensity	0 - 100%
2	Brightness	Electronic brightness control
3	Contrast	Electronic contrast control
4	Input select	Select between Input1,Input2...
5	Function select	Off,Focus,Zoom,....
6	>>	Motor 'go' direction
7	<<	Motor 'go' direction
8	White peaking	0 - 100

Image 13-49

DMX Monitor		
Channel	Function	Parameter
1	Intensity	0 - 100%
2	Brightness	###
3	Contrast	###
4	Input select	###
5	Function select	###
6	>>	###
7	<<	###
8	White peaking	###

Image 13-50



When selecting DMX monitor and no DMX device is connected, the message "No DMX data, check connection <ENTER> to display channels" appears on the screen. When ENTER is pressed the same window appears as DMX Monitor but without values.

#### About motor control (channel 6 and 7)

If channel #6 is brought to 32 or more, this is the same as "motor" forward (as pushing the button on the side panel). It also disables control of channel 7.

If channel #7 is brought to 32 or more, this is the same as "motor" reverse (as pushing the button on the side panel). It also disables control of channel 6.

Both channels above 32 means no action.

Channel 6 and 7:

- 0 - 31      No action
- 31 - 255    Action start

## About channel 4 and 5

Channel 4:

0 - 31	Input 1
32 - 63	Input 2
64 - 255	No image (pause)

Channel 5:

0 - 31	Off
32 - 63	Focus
64 - 95	Zoom
96 - 127	Horizontal shift
128 - 255	Vertical shift

### 13.6.4 DMX mode

#### What can be done ?

2 modes for DMX are available:

- Basic which has currently 2 channels implemented.
- Full which has currently 9 channels implemented and 10th free channel.

Depending on the DMX application the correct mode has to be selected.

For the complete DMX chart, see "DMX Chart", page 195.

#### How to set the mode

1. Press **MENU** to activate the menus.
2. Use the **▲** or **▼** key to select *Projector control* and press **ENTER**.
3. Use the **▲** or **▼** key to select *DMX* and press **ENTER**.
4. Use the **▲** or **▼** key to select *DMX mode* and press **ENTER** to toggle between [Basic] and [Full].

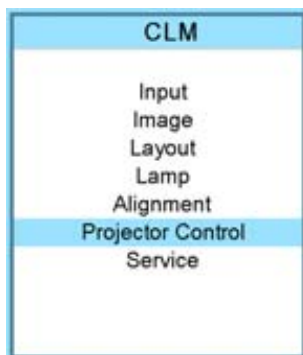

Image 13-51

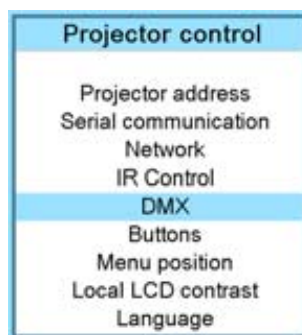

Image 13-52

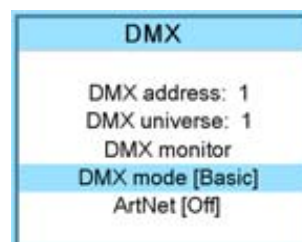

Image 13-53

### 13.6.5 Art-Net Activation

#### What can be done ?

DMX via Art-Net can be activated [On] or blocked [Off].

Default value : off

#### How to toggle

1. Press **MENU** to activate the menus.
2. Use the **▲** or **▼** key to select *Projector control* and press **ENTER**.
3. Use the **▲** or **▼** key to select *DMX* and press **ENTER**.
4. Use the **▲** or **▼** key to select *ArtNet* and press **ENTER** to toggle between [Off] and [On].

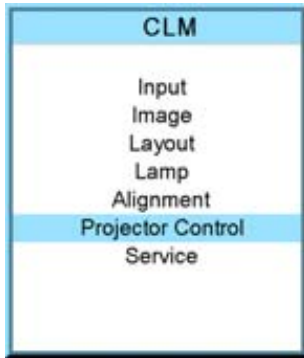

Image 13-54

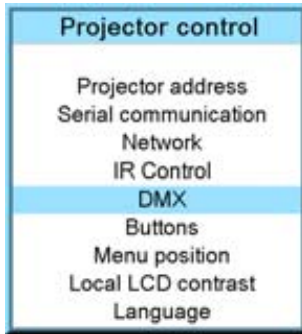

Image 13-55

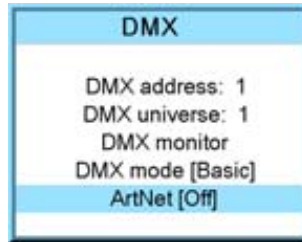

Image 13-56

## 13.7 Buttons

### Functionality

Some buttons on the RCU or local keypad can have a different functionality depending on the need of the projector owner.

### Overview

- APA button
- Shortcut keys

#### 13.7.1 APA button

##### What can be done?

The function of the APA button can be configured according to the wishes of the user.

The function can be:

- Auto align (only aligning of the preview window is executed).
- Auto-image menu. This function opens a auto image menu where the user can make his choice between auto align, auto contrast/brightness and auto phase.

##### How to configure the Auto button?

1. Press **MENU** to activate the menus.
2. Use the **▲** or **▼** key to select *Projector control* and press **ENTER**.
3. Use the **▲** or **▼** key to select *Buttons* and press **ENTER**.
4. Use the **▲** or **▼** key to select *APA* and press **ENTER** to toggle between [Align only] and [Auto-image menu].

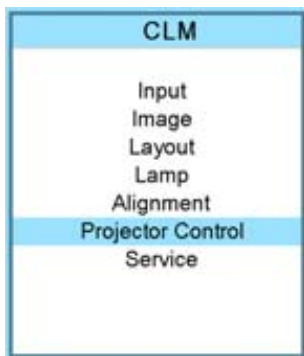

Image 13-57



Image 13-58

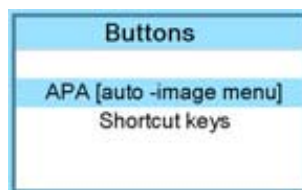

Image 13-59

#### 13.7.2 Shortcut keys

##### What can be done?

An overview of the shortcut allocations with the corresponding menu is given. Those printed in bold are allocated.



The allocated shortcut keys can be cleared within this menu.

### How to clear a shortcut key

1. Press **MENU** to activate the menus.
2. Use the **▲** or **▼** key to select *Projector control* and press **ENTER**.
3. Use the **▲** or **▼** key to select *Buttons* and press **ENTER**.
4. Use the **▲** or **▼** key to select *Shortcut keys* and press **ENTER**.
5. Use the **▲** or **▼** key to select a shortcut with allocation and press **ENTER** to remove the allocation.

The indication becomes *No allocation* and the key is free again for a new shortcut association.

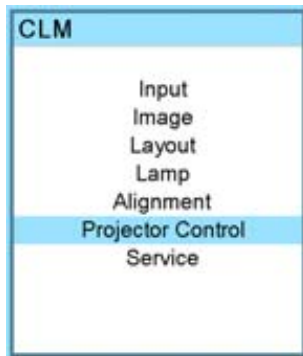

Image 13-60

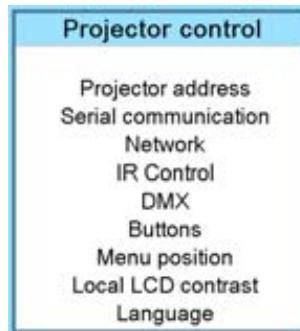

Image 13-61

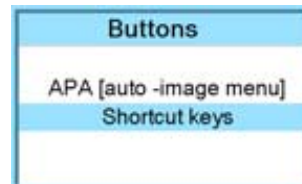

Image 13-62

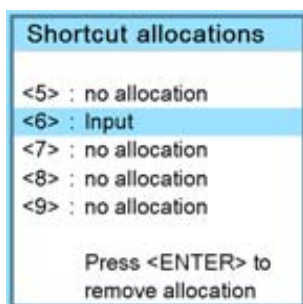

Image 13-63

## 13.8 Menu position

### What is possible?

The on screen menu and the bar scale can be positioned on different places on the screen.

Both can be positioned :

- Center
- Top
- Bottom

### How to change the position?

1. Press **MENU** to activate the menus.
2. Use the **▲** or **▼** key to select *Projector control* and press **ENTER**.
3. Use the **▲** or **▼** key to select *Menu position* and press **ENTER**.

The *Menu position* window opens

4. Use the **▲** or **▼** key to select *Menu* or *Barscale* and press **ENTER** to toggle between [Center], [Bottom] or [Top].

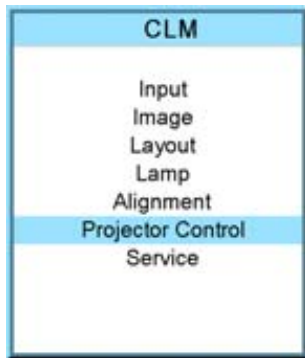

Image 13-64



Image 13-65



Image 13-66

### 13.9 Local LCD contrast

#### What is possible?

The contrast of the local LCD can be adapted to the needs of the environment.

#### How to change?

1. Press **MENU** to activate the menus.
2. Use the ▲ or ▼ key to select *Projector control* and press **ENTER**.
3. Use the ▲ or ▼ key to select *Local LCD contrast* and press **ENTER**.
4. Use the ▲ or ▼ key to adjust the local contrast.

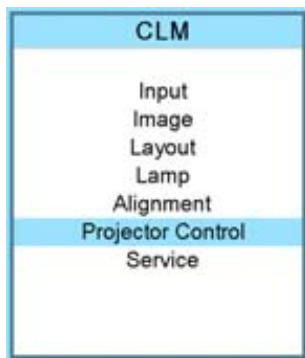

Image 13-67



Image 13-68

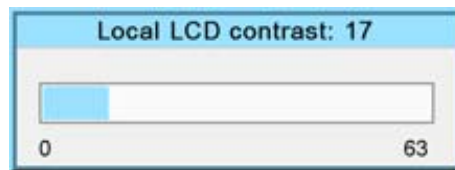

Image 13-69

### 13.10 Language selection

#### What can be done?

The user can change the language of the on screen menus and the local display menus to one of the available languages.

The following languages are available:

- English
- French
- German
- Spanish
- Italian

All available languages are indicated in the language of the country. The current active language is indicated by an asterisk (\*).

#### How to change the language

1. Press **MENU** to activate the menus.
2. Use the ▲ or ▼ key to select *Projector control* and press **ENTER**.

- Use the ▲ or ▼ key to select *Language* and press **ENTER**.
- Use the ▲ or ▼ key to select the desired language. The change will take effect immediately.

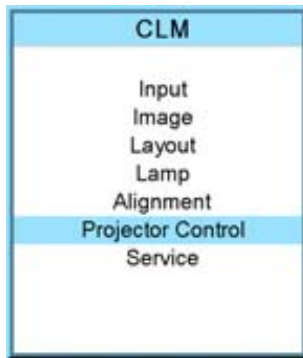

Image 13-70



Image 13-71



Image 13-72



## 14. SERVICE MENU

### About this chapter

This chapter refers to the Service menu in which the owner can find valuable information when calling the Barco help desk.

### Overview

- Overview flow
- Identification
- Diagnosis
- Internal service patterns
- Restore factory defaults
- Save custom settings
- Refill mode
- USB memory
- Over temperature DMD safety

### 14.1 Overview flow

#### Overview

Level 1	Level 2	Level 3
Service		
	Identification	
	Diagnosis	
		Version
		Voltages
		Temperatures
		Fan speeds
		Error logging
	Internal service patterns	
		PNP IN
		OSD
		PMP OUT
		FIB
		Formatter
	Restore factory defaults	
	Save custom settings	
	Refill mode	
	USB memory	
	Safety	
		Overtemperature DMD

### 14.2 Identification

#### What can be seen on the identification screen?

The identification screen shows the general information about the projector.

The following items will be displayed:

- Type of projector
- Projector address
- Package
- Configuration
- Baud rate
- IP address
- MAC address
- Text
- Serial number of projector: this number can be useful when calling for technical assistance.
- Runtime
- Lamp runtimes
- Customer ID

### How to display the screen?

1. Press **MENU** to activate the menus.
2. Use the **▲** or **▼** key to select *Service* and press **ENTER**.  
The service window opens.
3. Use the **▲** or **▼** key to select *Identification* and press **ENTER**.  
The identification screen is displayed.

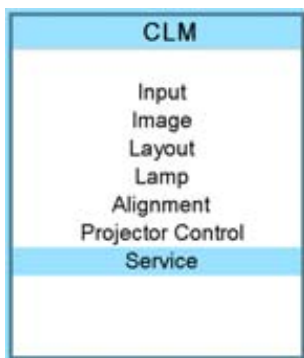

Image 14-1

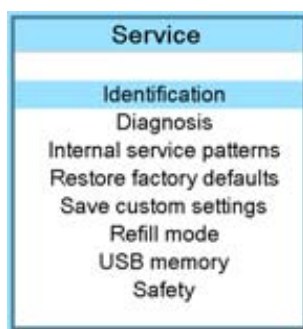

Image 14-2

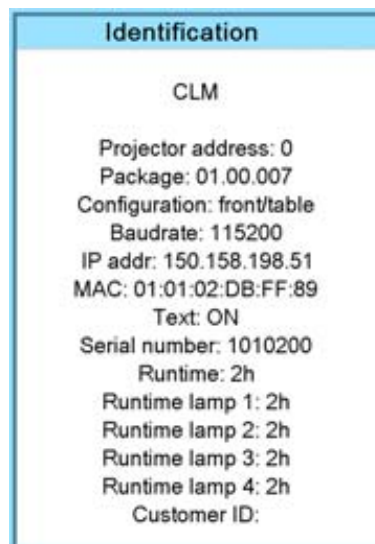

Image 14-3

### Add a customer ID to identification window

When on the identification window:

1. Use the **▲** or **▼** key to select *Customer ID* and press **ENTER**.  
The Customer ID input window opens.



Image 14-4

2. Use the **▲** or **▼** key to change the selected character.  
Use the **◀** or **▶** key to selected another character.  
**Note:** *Digits can be entered with the digit keys on the remote control or on the local keypad. When a digit is entered in that way, the next character will be selected automatically.*

## 14.3 Diagnosis

### What can be seen?

The diagnosis menu gives the possibility to get an overview of the working of the projector.

### 14.3.1 How to start up the diagnosis?

#### Start up

1. Press **MENU** to activate the menus.
2. Use the **▲** or **▼** key to select *Service* and press **ENTER**.  
The service window opens.
3. Use the **▲** or **▼** key to select *Diagnosis* and press **ENTER**.  
The diagnosis screen will be displayed.

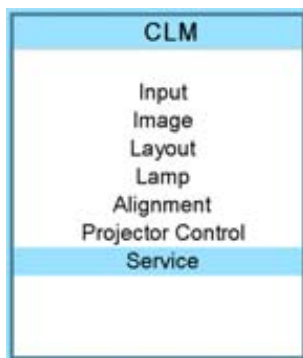

Image 14-5

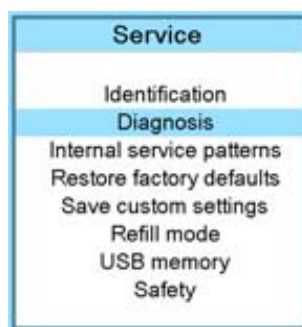

Image 14-6

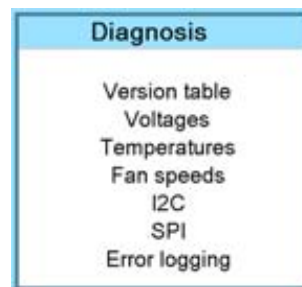

Image 14-7

### 14.3.2 Versions

#### How to display an overview?

1. Press **MENU** to activate the menus.
2. Use the **▲** or **▼** key to select *Service* and press **ENTER**.  
The service window opens.
3. Use the **▲** or **▼** key to select *Diagnosis* and press **ENTER**.  
The diagnosis screen is displayed.
4. Use the **▲** or **▼** key to select *Versions* and press **ENTER**.  
The Versions overview is displayed.

To see also the package info and to make a comparison with the current version, press on ►.

An indication is given of the current installed software is equal, smaller then or greater then the one in the package.

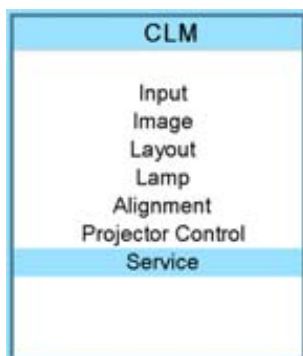

Image 14-8

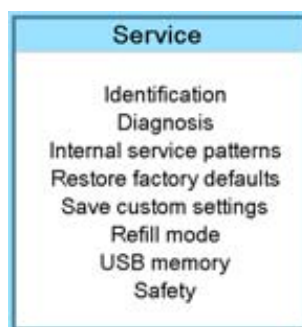

Image 14-9

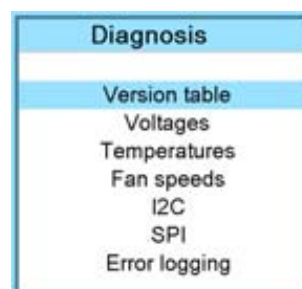

Image 14-10

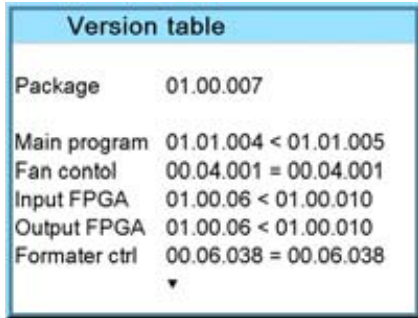

Image 14-11



Use the ▲ or ▼ item in the menu to select the previous or next page with information.

### 14.3.3 Voltages

#### How to display an overview?

1. Press **MENU** to activate the menus.
2. Use the ▲ or ▼ key to select *Service* and press **ENTER**.  
The service window opens.
3. Use the ▲ or ▼ key to select *Diagnosis* and press **ENTER**.  
The diagnosis screen will be displayed.
4. Use the ▲ or ▼ key to select *Voltages* and press **ENTER**.  
The Voltage overview menu will be displayed.

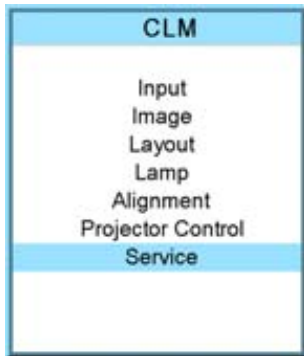

Image 14-12

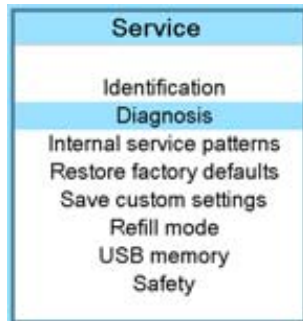

Image 14-13

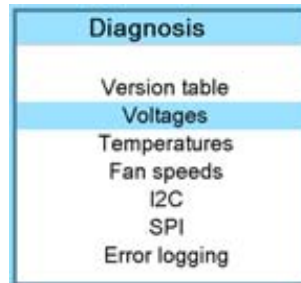

Image 14-14

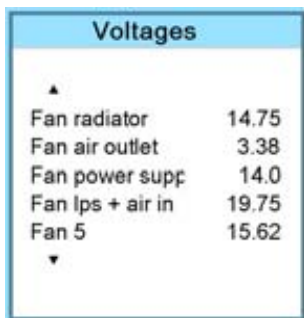

Image 14-15



Use the ▲ or ▼ item in the menu to select the previous or next page with information.



### 14.3.4 I<sup>2</sup>C diagnosis

#### How to select?

1. Press **MENU** to activate the menus.
2. Use the **▲** or **▼** key to select *Service* and press **ENTER**.  
The service window opens.
3. Use the **▲** or **▼** key to select *Diagnosis* and press **ENTER**.  
The diagnosis screen is displayed.
4. Use the **▲** or **▼** key to select *I2C* and press **ENTER**.  
The I<sup>2</sup>C diagnosis overview is displayed.

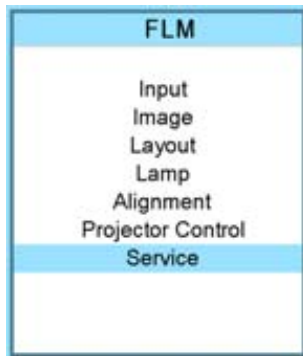

Image 14-16

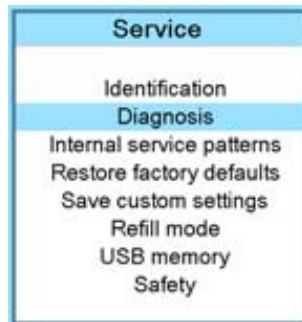

Image 14-17

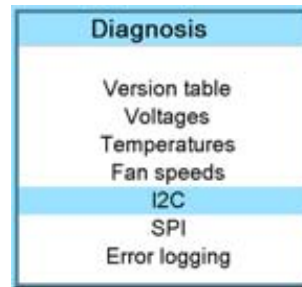

Image 14-18

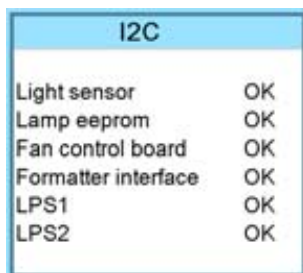

Image 14-19

### 14.3.5 Temperatures

#### How to get an overview?

1. Press **MENU** to activate the menus.
2. Use the **▲** or **▼** key to select *Service* and press **ENTER**.  
The service window opens.
3. Use the **▲** or **▼** key to select *Diagnosis* and press **ENTER**.  
The diagnosis screen will be displayed.
4. Use the **▲** or **▼** key to select *Temperatures* and press **ENTER**.  
The Temperature overview menu will be displayed.

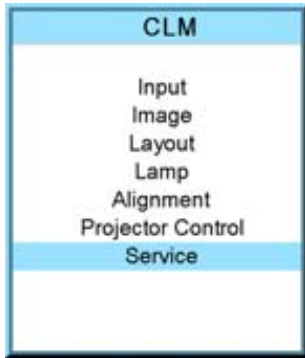

Image 14-20



Image 14-21

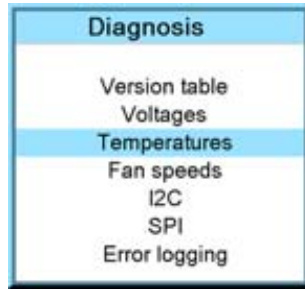

Image 14-22

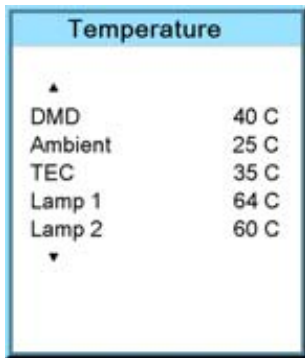

Image 14-23



Use the ▲ or ▼ item in the menu to select the previous or next page with information.

### 14.3.6 Fan speeds overview

#### How to get an overview?

1. Press **MENU** to activate the menus.
2. Use the ▲ or ▼ key to select *Service* and press **ENTER**.  
The service window opens.
3. Use the ▲ or ▼ key to select *Diagnosis* and press **ENTER**.  
The diagnosis screen will be displayed.
4. Use the ▲ or ▼ key to select *Fan speeds* and press **ENTER**.  
The Fan speeds overview menu will be displayed.

The current value is given together with the minimum required value in the following way : current value > minimum required value.

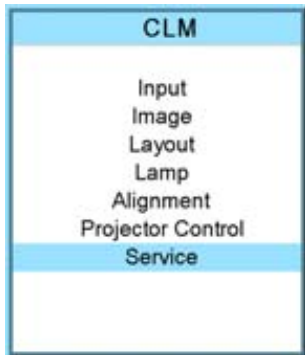

Image 14-24

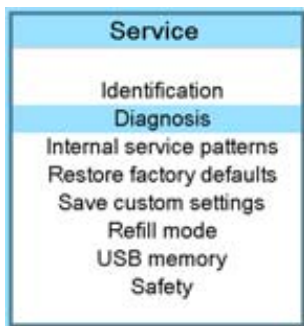

Image 14-25

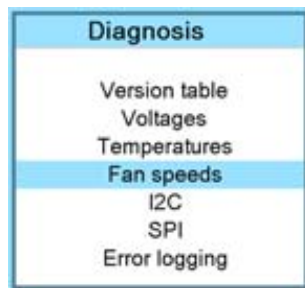

Image 14-26

Fan speeds			
▲			
Radiator A	2085 rpm	>	1000
Radiator B	1837 rpm	>	1000
Air outlet	1569 rpm	>	1000
Power supply A	3032 rpm	>	1000
Power supply B	3317 rpm	>	1000
▼			

Image 14-27



Use the ▲ or ▼ item in the menu to select the previous or next page with information.

### 14.3.7 SPI

#### How to get an overview

1. Press **MENU** to activate the menus.
2. Use the ▲ or ▼ key to select *Service* and press **ENTER**.  
The service window opens.
3. Use the ▲ or ▼ key to select *Diagnosis* and press **ENTER**.  
The diagnosis screen will be displayed.
4. Use the ▲ or ▼ key to select *SPI* and press **ENTER**.  
The SPI overview menu will be displayed.

CLM
Input
Image
Layout
Lamp
Alignment
Projector Control
Service

Image 14-28

Service
Identification
Diagnosis
Internal service patterns
Restore factory defaults
Save custom settings
Refill mode
USB memory
Safety

Image 14-29

Diagnosis
Version table
Voltages
Temperatures
Fan speeds
I2C
SPI
Error logging

Image 14-30

SPI	
Scaler	OK
Input fpga	OK
Output fpga	OK
Serial flash	OK

Image 14-31

### 14.3.8 Error logging overview

#### How to get an overview?

1. Press **MENU** to activate the menus.
2. Use the ▲ or ▼ key to select *Service* and press **ENTER**.  
The service window opens.

## 14. Service menu

---

3. Use the ▲ or ▼ key to select *Diagnosis* and press **ENTER**.

The diagnosis screen will be displayed.

4. Use the ▲ or ▼ key to select *Error logging* and press **ENTER**.

The Error logging overview menu is displayed.

For more explanation about the stored error message, see "Error codes", page 205.

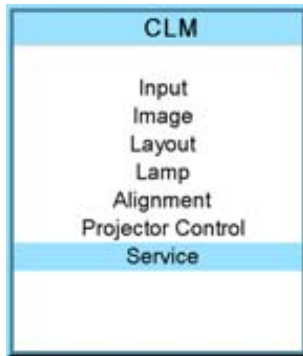

Image 14-32

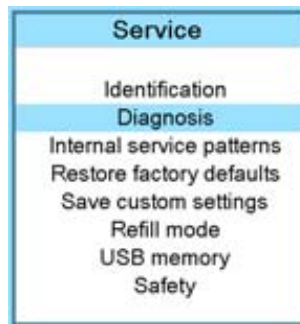

Image 14-33

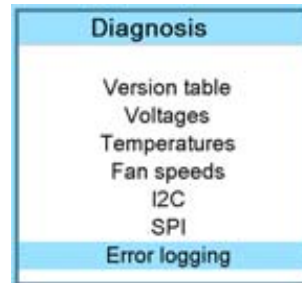

Image 14-34

## 14.4 Internal service patterns

---

### How to select

1. Press **MENU** to activate the menus.
2. Use the ▲ or ▼ key to select *Service* and press **ENTER**.  
The service window opens.
3. Use the ▲ or ▼ key to select *Internal service patterns* and press **ENTER**.

The internal service pattern window opens.

4. Use the ▲ or ▼ key to select the desired patterns and press **ENTER**.

When a pattern is selected, press **ENTER** to toggle to other patterns of the selected type. Press **EXIT** to return to the internal service pattern menu.

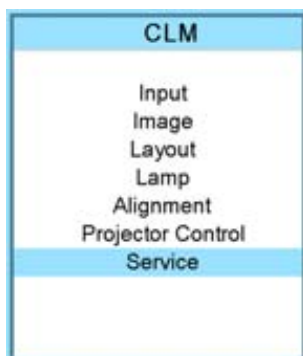

Image 14-35

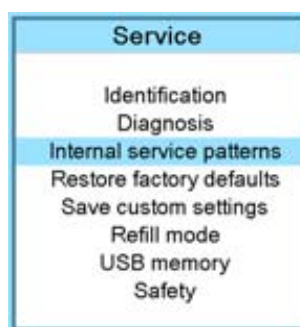

Image 14-36

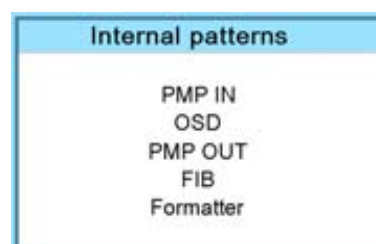

Image 14-37

## 14.5 Restore factory defaults

---

### What can be done?

All settings of the projector will be set to the original factory settings with the exception of the IP address, serial settings, DMX settings and High altitude mode. For these settings the choice exists to exclude them in the reset operation. .

### How to make an exception

1. Press **MENU** to activate the menus.

- Use the ▲ or ▼ key to select *Service* and press **ENTER**.  
The service window opens.
- Use the ▲ or ▼ key to select *Restore factory defaults* and press **ENTER**.  
The factory defaults confirmation window opens.
- Use the ▲ or ▼ key to select the setting to exclude and press **ENTER** to toggle between [No] and [Yes].  
Repeat this step if necessary for the other settings.

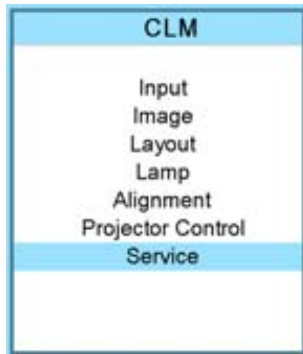

Image 14-38

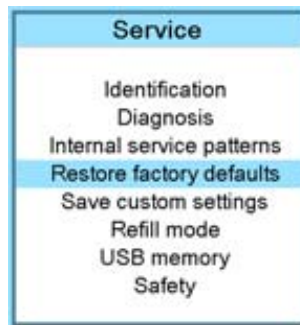

Image 14-39

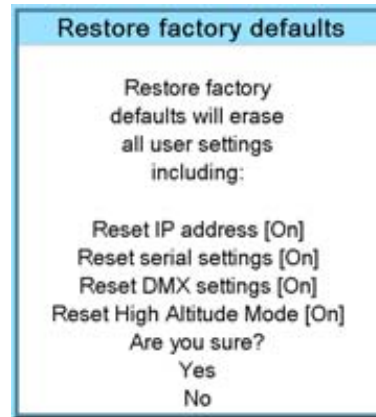

Image 14-40

### How to return to the default settings

- Press **MENU** to activate the menus.
- Use the ▲ or ▼ key to select *Service* and press **ENTER**.  
The service window opens.
- Use the ▲ or ▼ key to select *Restore factory defaults* and press **ENTER**.  
The factory defaults confirmation window opens.
- Use the ▲ or ▼ key to select *Yes* or *No* and press **ENTER**.  
If you are sure to restore the factory defaults and to erase the custom settings, select *Yes*.  
If you are not sure, select *No*.

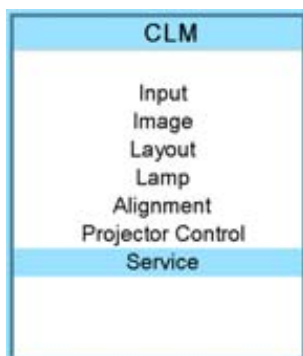

Image 14-41

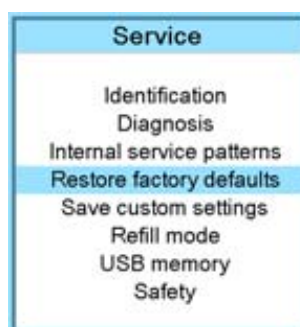

Image 14-42

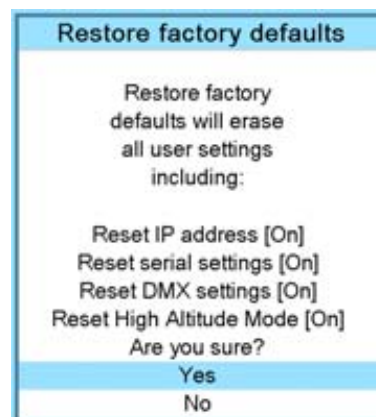

Image 14-43

## 14.6 Save custom settings

### What is done?

The current custom settings can be saved to the internal backup device in the same way as it would be done when the projector was switched to standby.

**How to save**

1. Press **MENU** to activate the menus.
2. Use the **▲** or **▼** key to select *Service* and press **ENTER**.  
The service window opens.
3. Use the **▲** or **▼** key to select *Save custom settings* and press **ENTER**.  
The custom settings are written to the internal backup device. A message menu "Save data ..." is displayed during the save operation.

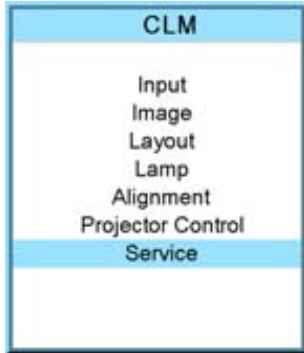

Image 14-44

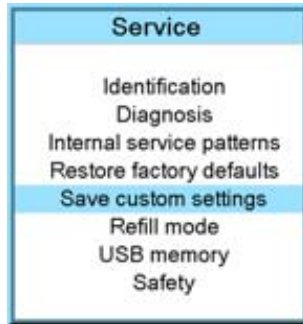

Image 14-45

**14.7 Refill mode**



**Before selecting Refill mode, take first all preparations necessary to refill the cooling circuit.**

**What can be done?**

When all preparations are taken, the refill mode will automatically activate the refill process.

**How to start the refill mode**

1. Press **MENU** to activate the menus.
2. Use the **▲** or **▼** key to select *Service* and press **ENTER**.  
The service window opens.
3. Use the **▲** or **▼** key to select *Refill mode* and press **ENTER**.  
A refill confirmation message is displayed.
4. Use the **▲** or **▼** key to select *Yes or No* and press **ENTER**.  
Yes will switch the projector in refill mode.  
When No is selected, the projector stays in normal mode.

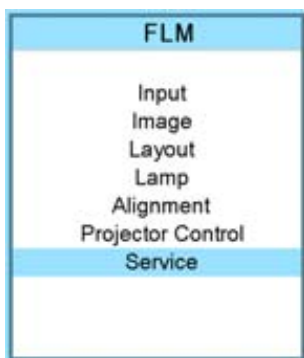

Image 14-46

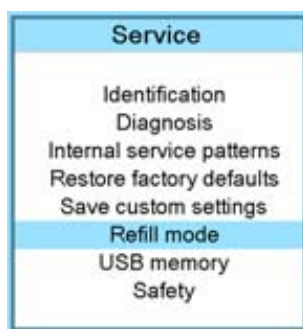

Image 14-47

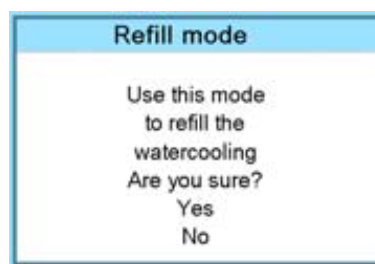

Image 14-48



**When the projector was in standby while selecting Refill mode, then the water-cooling pump will start pumping. Repower the projector to finish the refill mode.**

**When the projector was playing, it remains playing.**

## 14.8 USB memory

### What is possible with an USB device?

An USB device, FAT 16 formatted can be used, to save custom settings from the projector or to load custom settings to the projector. This function is very handy to clone projectors.

The following settings can be transported via an USB device:

- baudrate
- address
- common address
- orientation
- text on/off
- file load mode
- eco mode & dimming
- rs232 interface & rs232 termination
- no signal setup settings
- IR receiver settings
- native resolution
- min delay
- current language of on screen menus
- customer id
- Network settings (DHCP, IP address, net mask, gateway address)
- blanking & keystone
- ScenergiX
- gamma
- color standard
- source switching
- effect settings
- menu position
- button settings
- locking settings

### Saving custom settings

1. Connect a FAT 16 formatted USB device to the USB port.
2. Press **MENU** to activate the menus.
3. Use the **▲** or **▼** key to select *Service* and press **ENTER**.  
The service window opens.
4. Use the **▲** or **▼** key to select *USB memory* and press **ENTER**.
5. Use the **▲** or **▼** key to select *Save custom settings* and press **ENTER**.

## 14. Service menu

The custom settings on the projector are stored on the USB device together with the serial number of the projector. Different saves can be made from different projectors on the same USB device.

When there is no USB device connected to the USB slot, a message, *No USB device found*, is displayed.

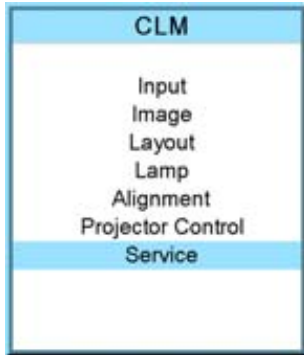

Image 14-49

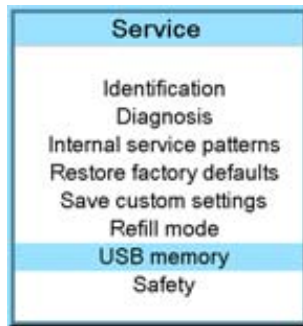

Image 14-50

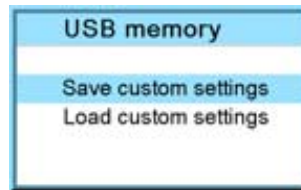

Image 14-51

### Load custom settings

1. Connect a FAT 16 formatted USB device to the USB port.
  2. Press **MENU** to activate the menus.
  3. Use the **▲** or **▼** key to select *Service* and press **ENTER**.
- The service window opens.
4. Use the **▲** or **▼** key to select *USB memory* and press **ENTER**.
  5. Use the **▲** or **▼** key to select *Load custom settings* and press **ENTER**.

An list of serial numbers is given.

6. Use the **▲** or **▼** key to select the serial number to start from to load the settings.

The settings from the selected projector on the USB device are loaded into the current attached projector. The current projector settings are overwritten with these settings.

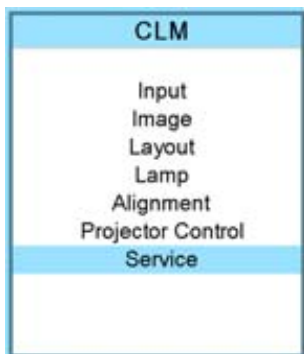

Image 14-52

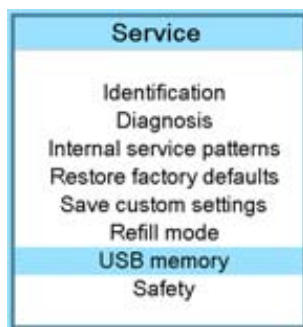

Image 14-53

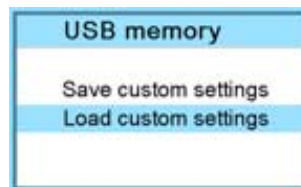

Image 14-54

## 14.9 Over temperature DMD safety

### What can be done

When the temperature of the DMD becomes higher than the normal operation temperature (between 60 and 64 °C) it is possible to switch the lamp mode of the projector automatically from 4 lamps to 2 lamps so that the DMD temperature can cool down. A warning remains on the local LCD panel and the warning LED is on as long as the temperature is too high. When the temperature exceeds 64°C then the projector is switched to standby and an error is displayed on the LCD panel.

### How to configure the over temperature safety

1. Press **MENU** to activate the menus.
2. Use the **▲** or **▼** key to select *Service* and press **ENTER**.
3. Use the **▲** or **▼** key to select *Safety* and press **ENTER**.



4. Use the ▲ or ▼ key to select *Overtemp DMD* and press **ENTER** to toggle between [On] and [Off].

**On** When temperature is too high, lamp mode is switched from 4 to 2 lamps. The 4 lamps mode can only be restored after switching first to standby and restarting the projector.

If the temperature exceeds 64 °C, the projector is switched to standby.

**Off** for a temperature between 60 and 64 °C the projector continues in normal operation but the warning is set on the LCD display. Once the temperature is higher than 64 °C, then the projector is switched to standby.

The following text is displayed on the LCD: "DMD temperature to high. Please, check cooling liquid level ! Check dust filters ! Press any key to confirm."

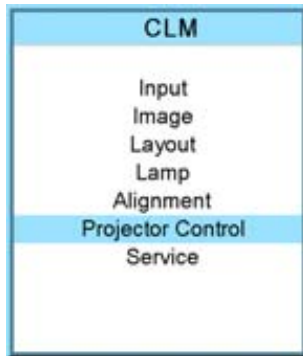

Image 14-55

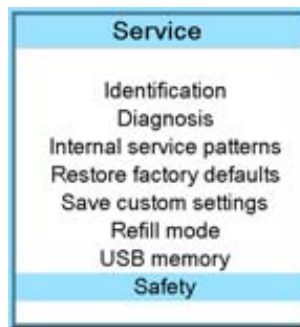

Image 14-56

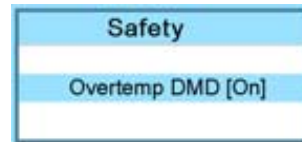

Image 14-57



# 15. MAINTENANCE

## About this chapter

This chapter contains detailed maintenance procedures like lens cleaning, etc. These procedures can easily be performed by the operator of the projector.

## Overview

- Cleaning the lens
- Cleaning the exterior of the projector
- Level check of cooling liquid

## 15.1 Cleaning the lens



To minimize the possibility of damage to optical coatings, or scratches to lens surfaces, we have developed recommendations for cleaning. **FIRST, we recommend you try to remove any material from the lens by blowing it off with clean, dry deionized air. DO NOT use any liquid to clean the lenses.**

### Necessary tools

Toraysee™ cloth (delivered together with the lens kit). Order number : R379058.

### How to clean the lens ?

1. Always wipe lenses with a CLEAN Toraysee™ cloth.
2. Wipe lenses in a one single direction.  
**Warning:** *Do not wipe back and forwards across the lens surface as this tends to grind dirt into the coating.*
3. Do not leave the cleaning cloth in either an open room or lab coat pocket, as doing so can contaminate the cloth.
4. If smears occur when cleaning lenses, replace the cloth. Smears are the first indication of a dirty cloth.



**CAUTION:** Do not use fabric softener when washing the cleaning cloth or softener sheets when drying the cloth.

Do not use liquid cleaners on the cloth as doing so will contaminate the cloth.



Other lenses can also be cleaned safely with this Toraysee™ cloth.

## 15.2 Cleaning the exterior of the projector

### How to clean the exterior of the projector ?

1. Switch off the projector and unplug the power cord at the projector side.
2. Clean the housing of the projector with a damp cloth. Stubborn stains may be removed with a cloth lightly dampened with a mild detergent solution.

## 15.3 Level check of cooling liquid

### What should be done ?

The projector is liquid cooled. When running with a low liquid cooling level then the cooling capacity is strongly reduced which results in higher temperatures inside the projector. These higher temperatures can cause an interruption of your show as the lamps can be switched off by the software as a preventive step.

To avoid this problem, we strongly advise to check at least every 3 months the cooling level in the cooling reservoir of the projector.



**WARNING: Switch off the projector and pull out the power cord before starting the check procedure !**

---

### How to check

Remove :

- lamp door, see "Removal of the lamp door", page 182.
- front cover, see "Removal of the front cover", page 181.
- back cover, see "Removal of the back cover", page 183.
- top cover, see "Removal of the top cover", page 184.
- side cover, see "Removal of the side cover", page 184.

#### 1. Check the cooling liquid level.

When the white indication line is in the *service* area, then the reservoir has to be topped-up again. To top-up the reservoir, see chapter "16. Servicing", "Top-up the reservoir with cooling liquid", page 177.

When the white indication is in the *good* area, no corrective action should be taken. Close the top cover and fasten both captive screws.



Image 15-1  
Check cooling liquid

# 16. SERVICING

## About this chapter

This chapter contains general servicing procedures like lamp replacement, input unit replacement etc. Note that some of these procedures may only be performed by qualified technical service personnel. These procedure are marked with a warning.

## Extra service information

Extra service information for qualified service technicians can be found on Barco's Partnerzone (URL:[www.partnerzone.events.barco.com](http://www.partnerzone.events.barco.com)). Registration is necessary.

If you are not yet registered, click on Partnerzone registration and follow the instructions. With the created login and password, it is possible to enter the partnerzone where you can find extra service information about the projector.



### HEPA

High Efficiency Particulate Absorbing

## Overview

- Replacement of the dust filter on the top side
- Replacement of the dust filters on the front side
- Lens installation
- Lens removal
- Removal of a lamp unit
- Mounting a new lamp unit
- Removal of an input module
- Inserting an input module
- Top-up the reservoir with cooling liquid



**CAUTION:** All HEPA filters of the projector must be replaced on a regular basis, depending on the environment conditions of the projector.

## 16.1 Replacement of the dust filter on the top side



All dust filters in the projector are identical.

### Necessary parts

New HEPA dust filter.

### How to replace the filter on top of the projector

1. Switch off the projector and unplug the power cord from the wall outlet.
2. Remove the lamp door, see "Removal of the lamp door", page 182.
3. Take the filter on the side parallel with the cover and pull it upwards (A). Pivot it a little and take it out (B).

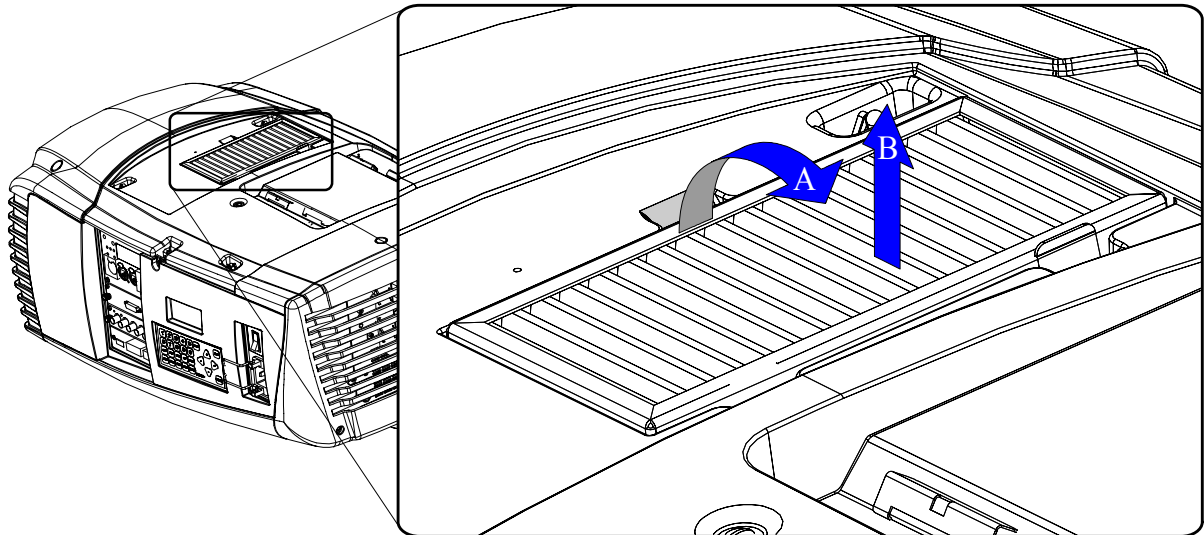

Image 16-1  
Filter top replacement

4. Insert a new HEPA filter first with the side next to the lamp housing and pull down the other side to lock the filter.
5. Reinstall the lamp door, see "Installation of the lamp door", page 188.



**CAUTION:** Never install a used HEPA filter. Always install a new HEPA filter.



**CAUTION:** Never use the projector with a removed cover. Always reinstall the removed cover.

## 16.2 Replacement of the dust filters on the front side

### Necessary parts

Two new HEPA dust filters.

### How to replace the filters on the front side of the projector

1. Switch off the projector and unplug the power cord from the wall outlet.
2. Remove the front cover, see "Removal of the front cover", page 181.
3. Remove the HEPA filter on the front side by pulling the spring clamp (A) on the upper side away from the filter and then pivot the filter a little ( B) and take it out (C).

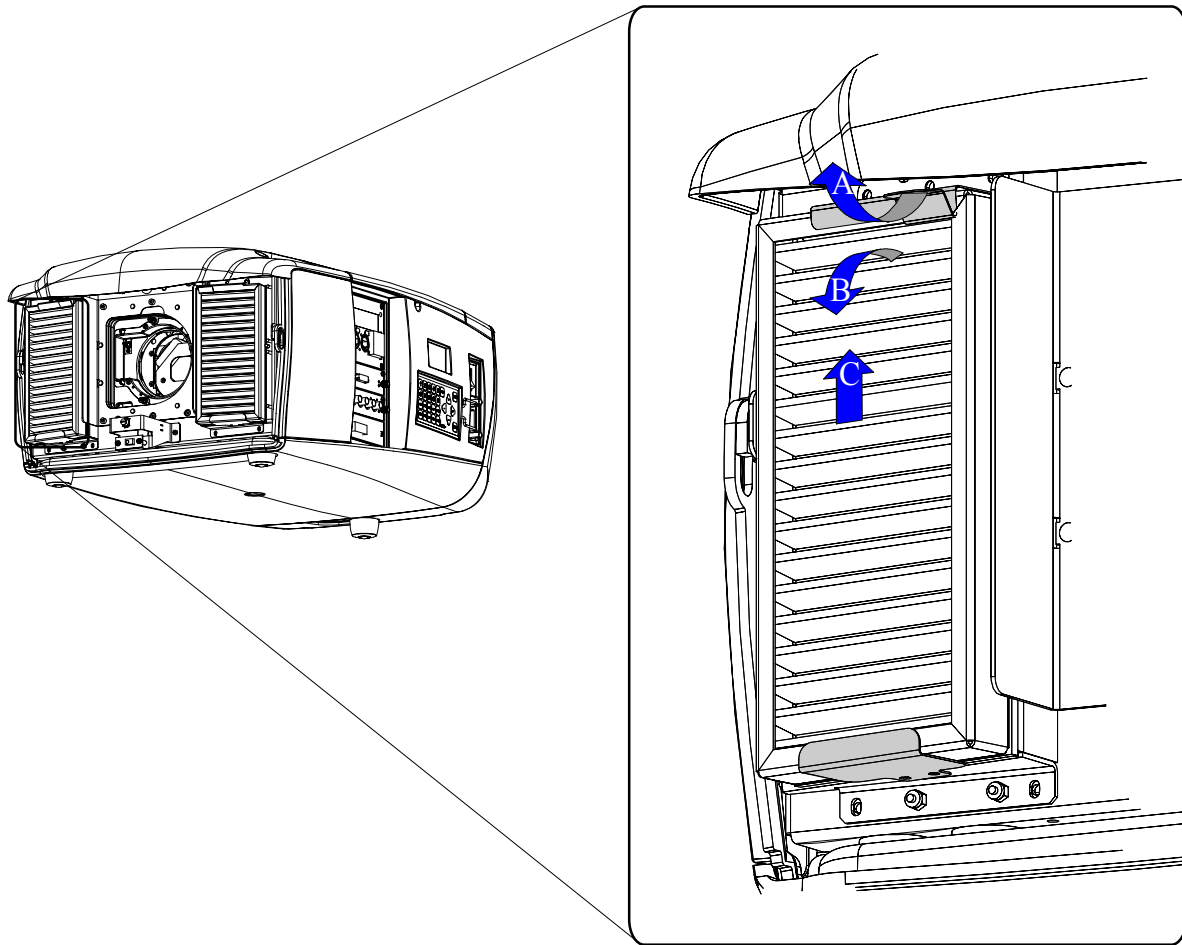

Image 16-2  
Front filter replacement

4. Insert a new HEPA filter by pulling the spring clamp away and insert the filter into its position. Release the spring clamp.
5. Reinstall the front cover of the projector, see "Installation of the front cover", page 187.



**CAUTION:** Never install a used HEPA filter. Always install a new HEPA filter.



**CAUTION:** Never use the projector with a removed cover. Always reinstall the removed cover.

### 16.3 Lens installation

#### How to install the lens

1. Remove the front cover of the projector. See "Removal of the front cover", page 181.
2. Remove the foam rubber in the opening of the lens holder if not yet removed.
3. Place the lock handle A in its right position (table mounted projector).

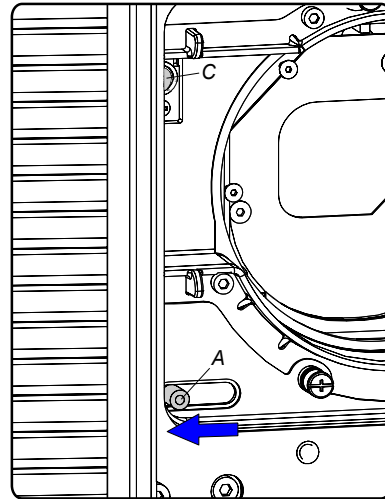
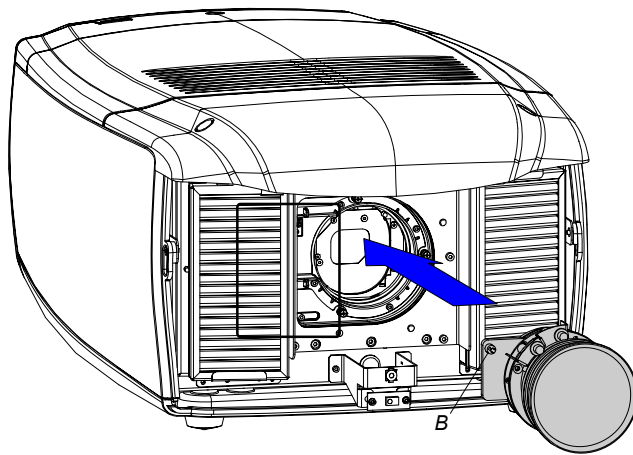

Image 16-3  
Mounting the lens

4. Insert the lens in such a way that the female jack (C) is in front of the male jack (upper left corner) (B) and ensure the lens touches the front plate of the lens holder.  
**Caution:** *Do not release the lens yet, as the lens may fall out of the lens holder.*
5. Secure the lens in the lens holder by sliding the lens lock handle A into the "locked" position (left position for table mounted projector).
6. Check if the lens is really secured by trying to pull the lens out of the lens holder.



**CAUTION:** Never transport the projector with a Lens mounted in the Lens Holder. Always remove the Lens before transporting the projector. Neglecting this can damage the Lens Holder and Prism.

## 16.4 Lens removal

### How to remove the lens

1. Remove the front cover of the projector. See "Removal of the front cover", page 181.
2. Support the lens with one hand and push the lens lock handle to the right.

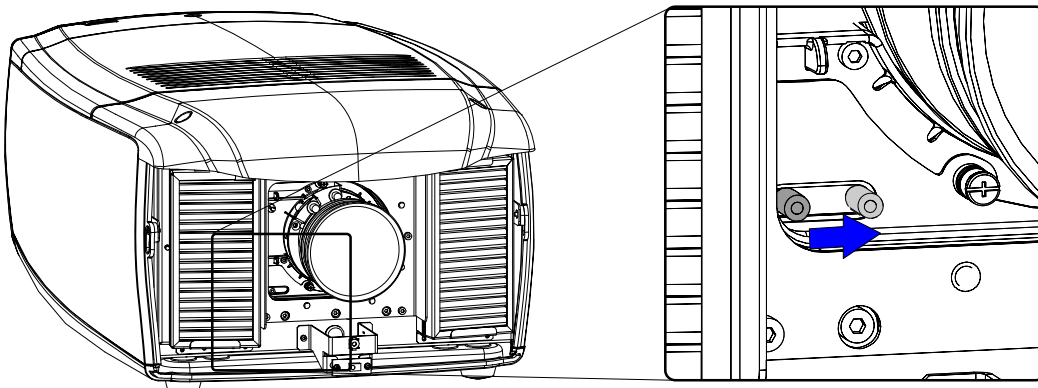

Image 16-4  
Lens removal

3. Pull out the lens backward until the jack connection is open (A). Slide the lens out of the lens holder.



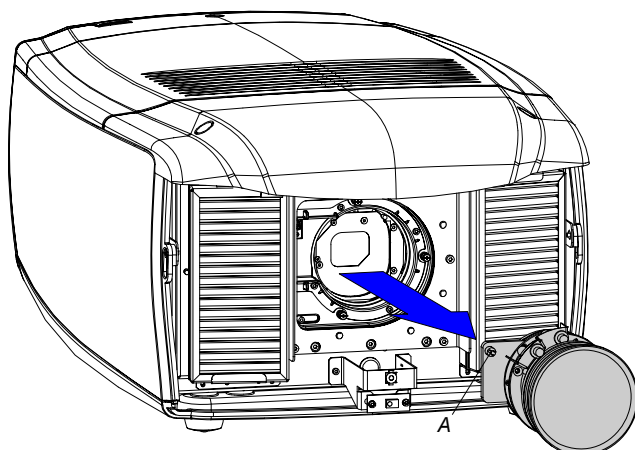

Image 16-5  
Slide out lens

## 16.5 Removal of a lamp unit



**WARNING:** This procedure may only be performed by qualified technical service personnel.



**CAUTION:** Never attempt to disassemble the lamp from its housing or to dispose of it. Due to its high internal pressure, the lamp may explode in either hot or cold states if improperly handled. For recycling guidelines, see "Recycling guidelines", page 8.

### About the lamps

The projector contains 4 lamps, each of them in a separate lamp house. Each lamp can be individually replaced by a spare lamp. Each lamp position has a number. That number is also used in the software to identify the parameters of the corresponding lamp.

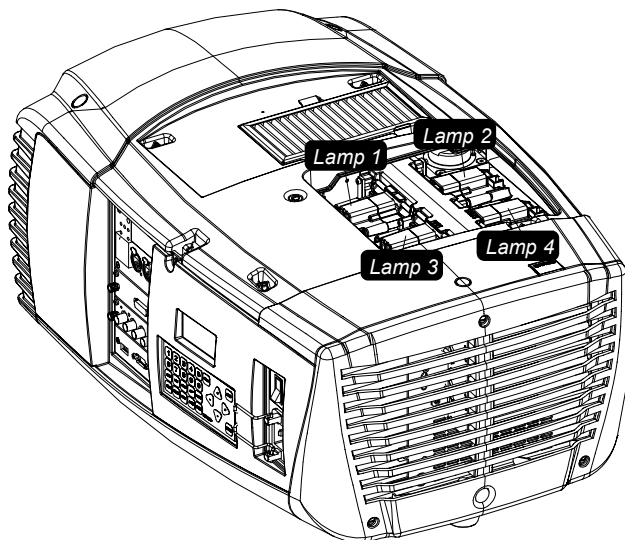

Image 16-6  
Lamp position

### When servicing a projector with exploded lamp

Keep the following warning in mind when servicing a projector with exploded lamp.

**Mercury Vapor Warnings:** The lamp used in the projector contains mercury. In case of a lamp rupture, explosion there will be a mercury vapor emission. In order to minimize the potential risk of inhaling mercury vapors:

- Ensure the projector is installed only in ventilated rooms.
- Replace the lamp module before the end of its operational life.
- Promptly ventilate the room after a lamp rupture, explosion has occurred, evacuate the room (particularly in case of a pregnant woman).
- Seek medical attention if unusual health conditions occur after a lamp rupture, explosion, such as headache, fatigue, shortness of breath, chest-tightening coughing or nausea.

**Necessary tools**

No tools.

**How to remove a lamp**

1. Switch off the projector and unplug the power cord from the wall outlet.
2. Remove the lamp door, see "Removal of the lamp door", page 182.
3. Unplug the cable of the lamp which must be removed.

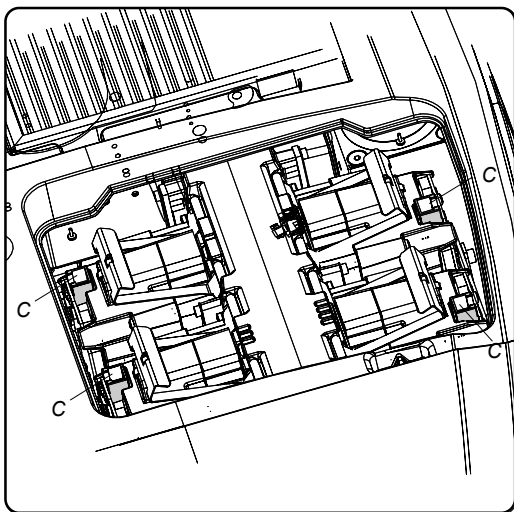

Image 16-7

4. Pull up the fixation handle and rotate it fully upwards.

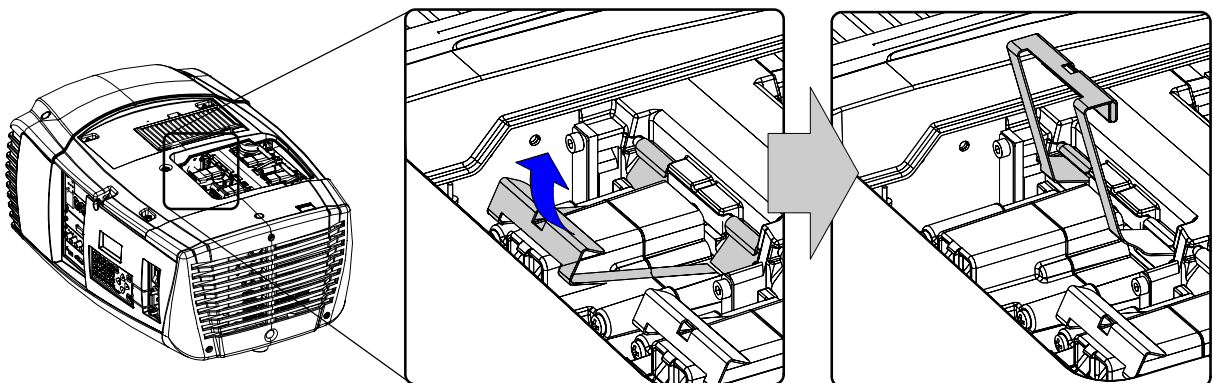

Image 16-8  
Lamp removal

5. Clasp the lamp and pull upwards.

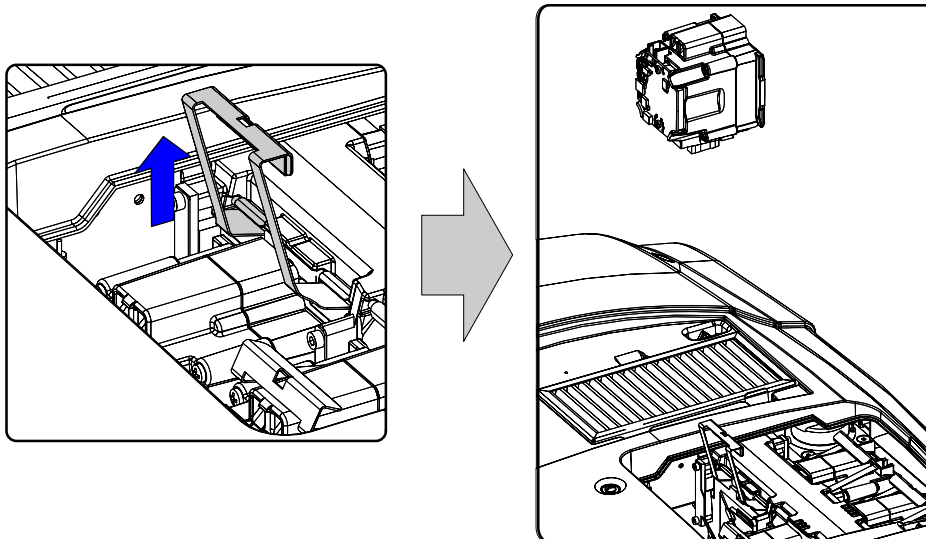

Image 16-9  
Take out the lamp



For recycling guidelines of the lamp, see "Recycling guidelines", page 8.

## 16.6 Mounting a new lamp unit

### About the lamp units

All four lamp units are equal. A spare lamp can be inserted in any position without problems. See spare part list for the order numbers.



**WARNING:** This procedure may only be performed by qualified technical service personnel.



**CAUTION:** Never attempt to disassemble the lamp from its housing or to dispose of it. Due to its high internal pressure, the lamp may explode in either hot or cold states if improperly handled. For recycling guidelines, see "Recycling guidelines", page 8.



**CAUTION:** Never touch the reflector or the lamp bulb with your fingers. That will reduce the lifetime of the lamp.

Never touch the UV filter when a lamp is removed.

### Necessary tools

No tools.

### How to insert a lamp unit

1. Insert the lamp vertically into the housing, with the front of the lamp facing the middle of the projector.

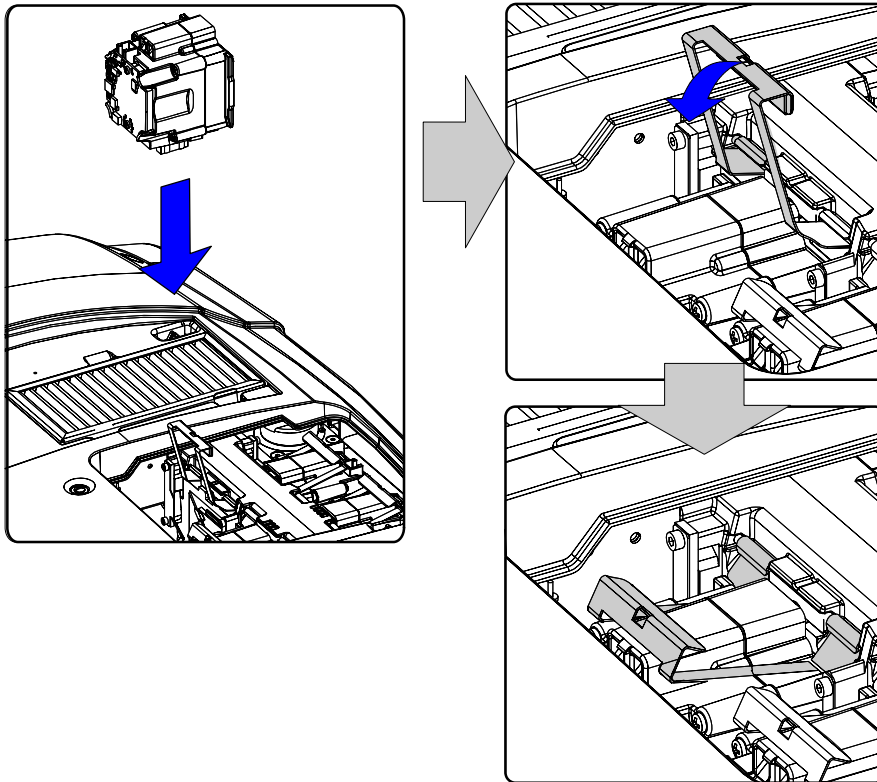

Image 16-10  
Lamp insertion

2. Rotate the fixation handle and close it. Push till it clicks.
3. Insert the cable connector into lamp unit socket.

## 16.7 Removal of an input module

### Necessary tools

Phillips screw driver PH1

### How to remove an input module

1. Switch off the projector and unplug the power cord at the projector side.
2. Release the two captive screws of the input module.

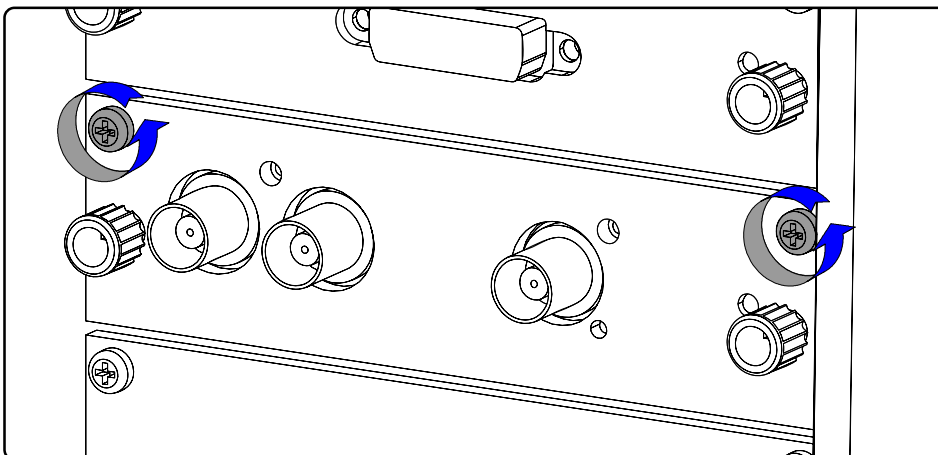

Image 16-11  
Input module removal

3. Pull out the input module via the two provided knobs.



**CAUTION:** Ensure that an unused slot is always covered with a dummy front plate. Immediately install after removing an input module a new input module or a dummy front cover.

## 16.8 Inserting an input module

### Necessary tools

Phillips screw driver PH1

### How to insert an input module

1. Ensure the projector is switched off and the power cord at the projector side is unplugged.
2. Slide the input module into the guides of the input slot.

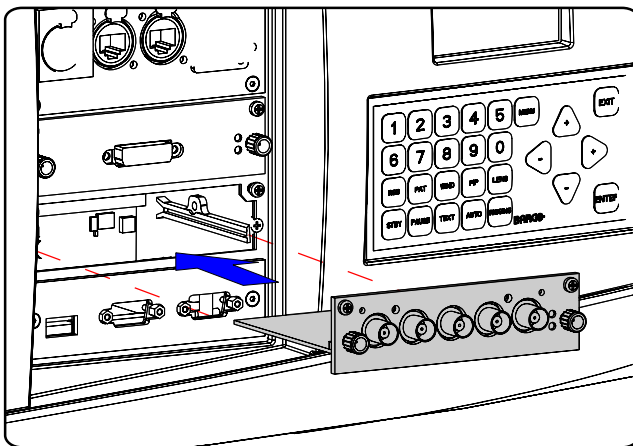

Image 16-12  
Insert module

3. Push the input module forward until you feel that the connector of the input module fit in the socket of the input slot. The back of the front plate of the module must touch the front plate of the input unit.
4. Secure the input module by fastening both captive screws in the top corners of the module.

## 16.9 Top-up the reservoir with cooling liquid

### Access to the reservoir

1. Switch off the projector and pull out the power cord from the power outlet.

Remove :

- lamp door, see "Removal of the lamp door", page 182.
- front cover, see "Removal of the front cover", page 181.
- back cover, see "Removal of the back cover", page 183.
- top cover, see "Removal of the top cover", page 184.
- side cover, see "Removal of the side cover", page 184.

The reservoir is mounted half a way of the side of the projector.

### Top-up procedure

1. Turn the bolt to release the pressure (1) . Turn until the white indication line is in the *Open* area (membrane is at the bottom of the reservoir) or until you feel to much resistance.
2. If you feel to much resistance, turn off the main lid on top of the reservoir (A).

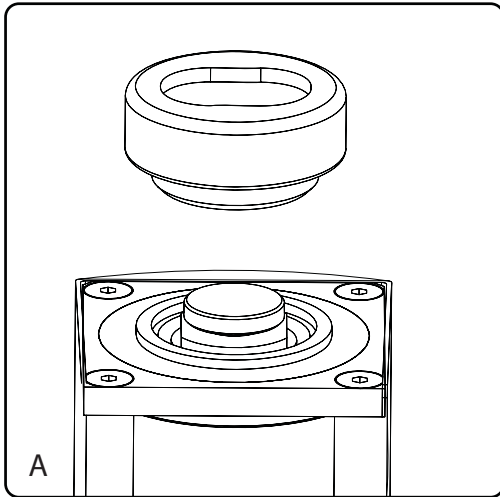
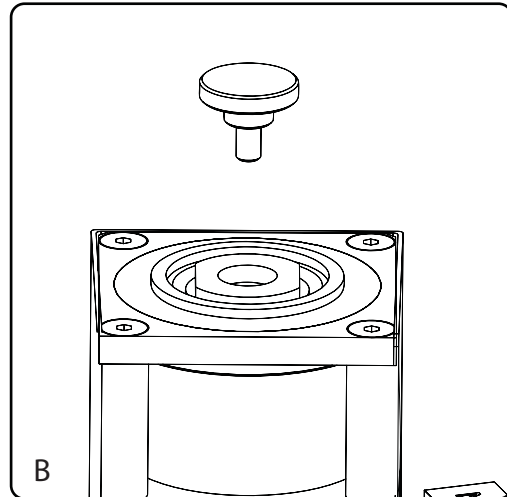

Image 16-13  
Open reservoir



3. Loosen the bleed lid a little so that air can enter and close the bleed lid again.
4. Turn on the bolt so that the white indication line is in the *Open* area (membrane is at the bottom of the reservoir).
5. Turn the bleed lid a little and take it out (B)
6. Turn out the third lid using the back of the main lid.

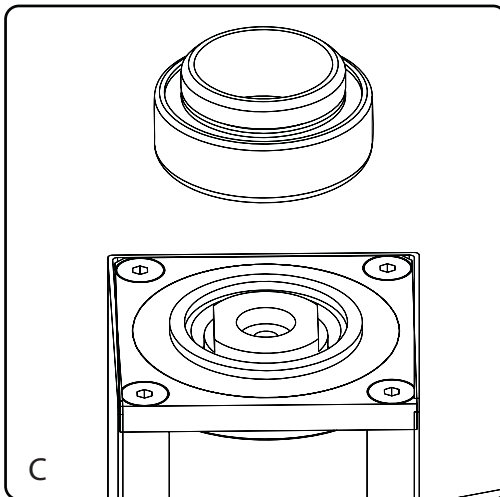
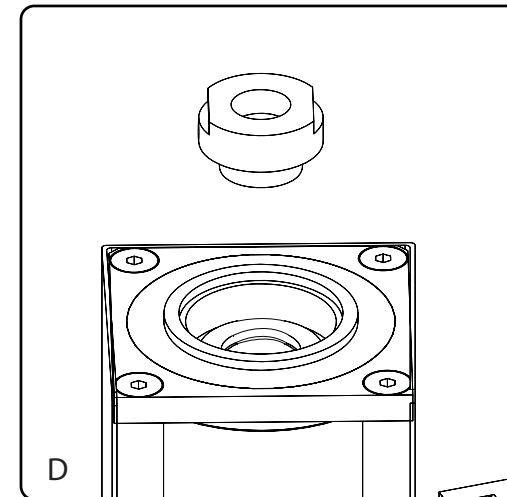

Image 16-14  
Remove third lid



7. Top-up the reservoir with cooling liquid until the level is somewhat higher than the hole in the reservoir.

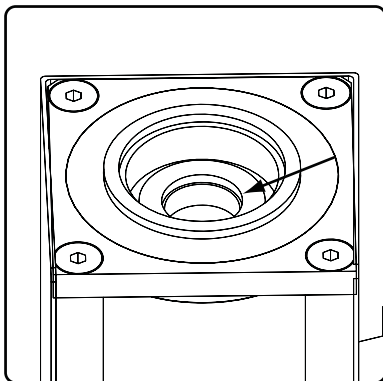

Image 16-15  
Top-up reservoir

8. Close the third lid again using the back of the main lid. Use a cloth to dab the residue of cooling liquid.  
**Note:** *Make sure that no cooling liquid is spilled in the projector.*
9. Turn in the bleed lid.

10. Close the main lid.

11. Pressurize the circuit by turning the bolt to the left until there is 2 cm free thread between the bolt and the bottom of the reservoir (the white indication line should be in the good area).

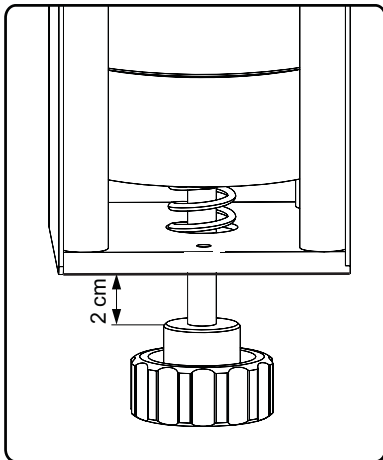

Image 16-16  
Pressurize circuit

Reinstall all projector covers :

- side cover, see "Installation of the side cover", page 185.
- top cover, see "Installation of the top cover", page 186.
- back cover, see "Installation of the back cover", page 186.
- front cover, see "Installation of the front cover", page 187.
- lamp door, see "Installation of the lamp door", page 188.





# 17. PROJECTOR COVERS, REMOVAL AND INSTALLATION

## Overview

- Removal of the front cover
- Removal of the lamp door
- Removal of the back cover
- Removal of the top cover
- Removal of the side cover
- Installation of the side cover
- Installation of the top cover
- Installation of the back cover
- Installation of the front cover
- Installation of the lamp door



**WARNING:** The cover removal procedures may only be performed by qualified technical service personnel.

## 17.1 Removal of the front cover

### Necessary tools

Flat screwdriver

### How to remove the front cover

1. Release the captive screw at the middle bottom of the front cover (a)

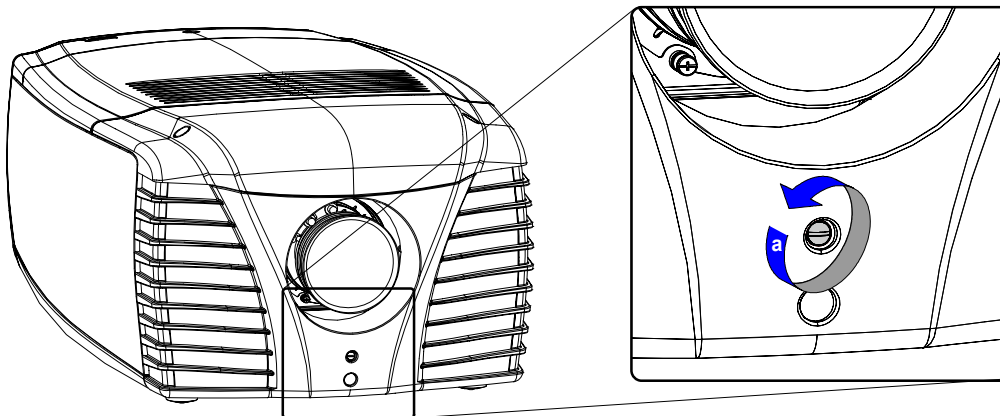

Image 17-1  
Release captive screw

2. Release the front cover from the projector doing the following:
  - a) stand in front of the projector and pull the bottom side of the cover a little toward you (b)
  - b) In that slightly pivoted position, pull the cover downwards to release it from the top cover (c)

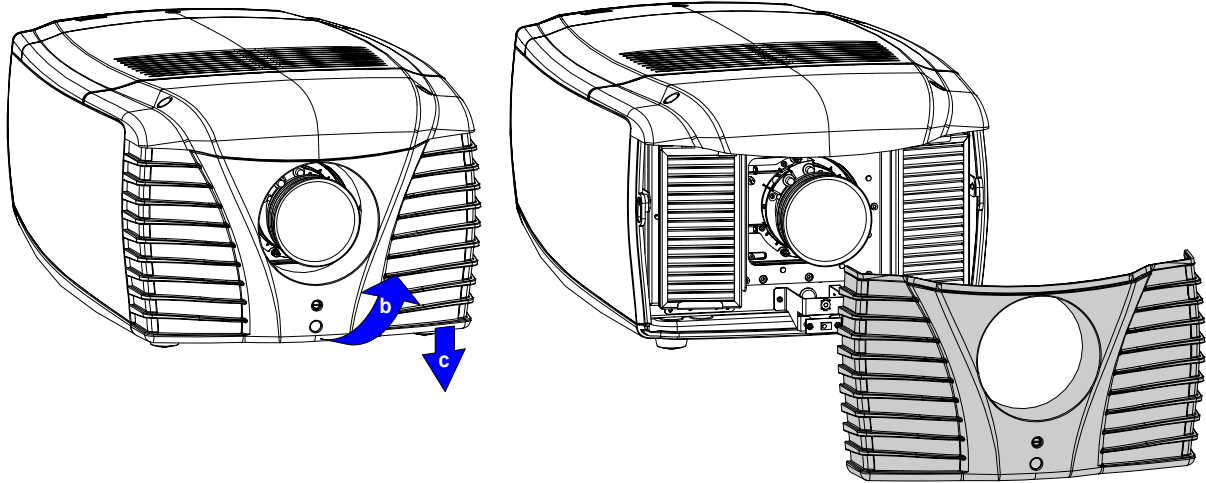

Image 17-2  
Remove the front cover

## 17.2 Removal of the lamp door

---



**WARNING:** This procedure may only be performed by qualified technical service personnel.

---

### Necessary tools

Flat screwdriver

### How to remove the lamp door

1. Release the captive screw at the middle upper side of the side cover on the input side.

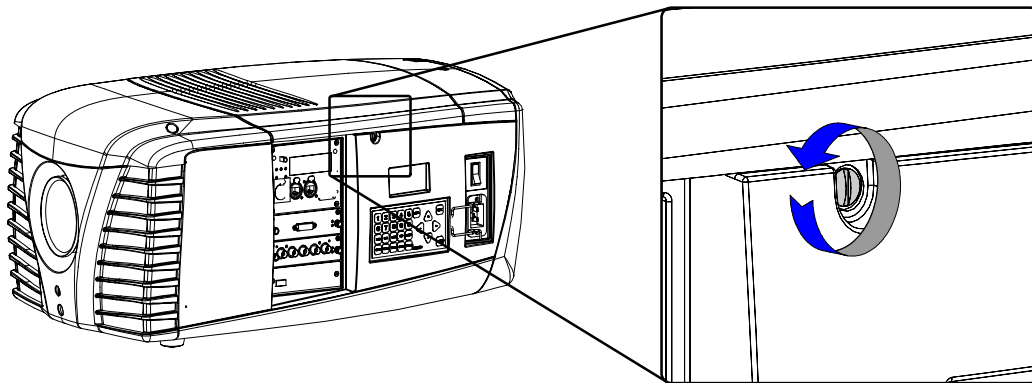

Image 17-3  
Release captive screw

2. Take the lamp door with both hands, one on each side, and pull it upward until the cover comes free from its 4 locks.

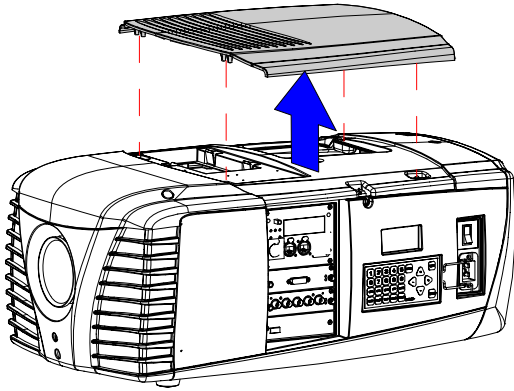

Image 17-4  
Remove lamp door

### 17.3 Removal of the back cover

#### Necessary tools

Flat screwdriver

#### How to remove the back cover

1. Release the 3 captive screws in the back cover.

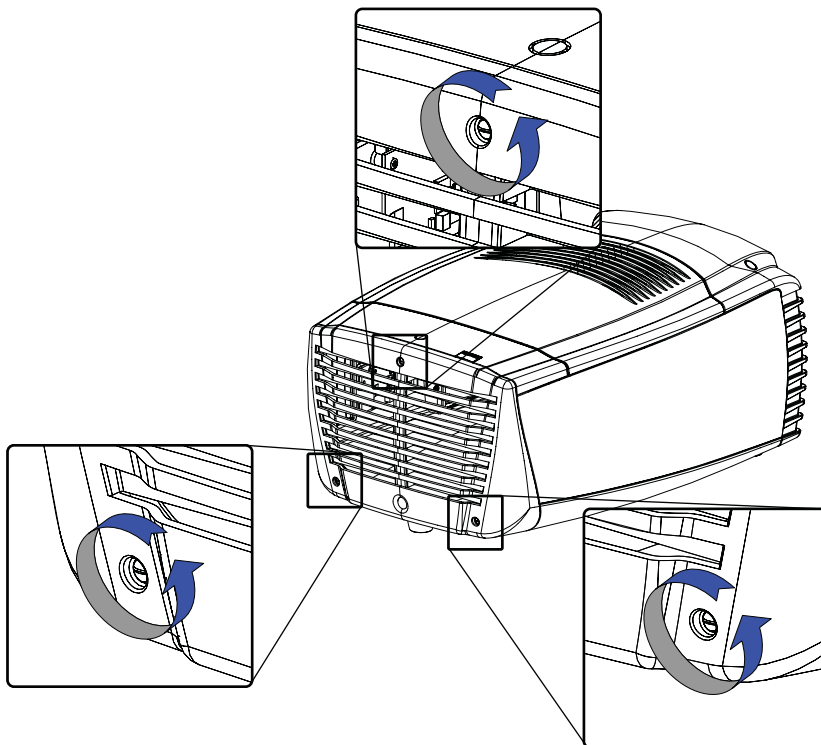

Image 17-5  
Release captive screws

2. Pull off the back cover.

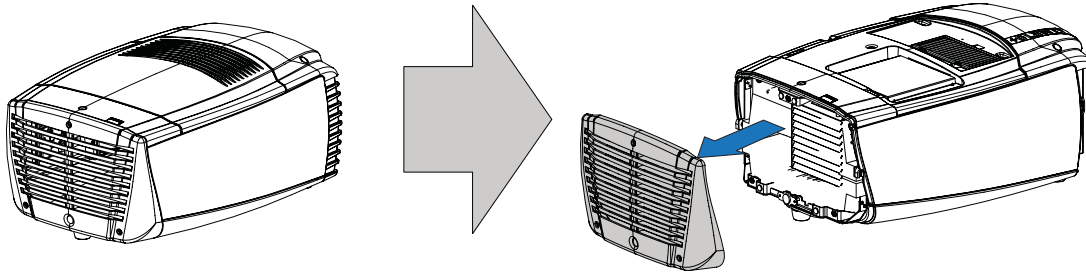

Image 17-6  
Remove back cover

## 17.4 Removal of the top cover

---



To remove the top cover, first remove the front and back cover and the lamp door.

---

### Necessary tools

Flat screwdriver

### How to remove the top cover

1. Release the captive screw in the middle of the top cover.

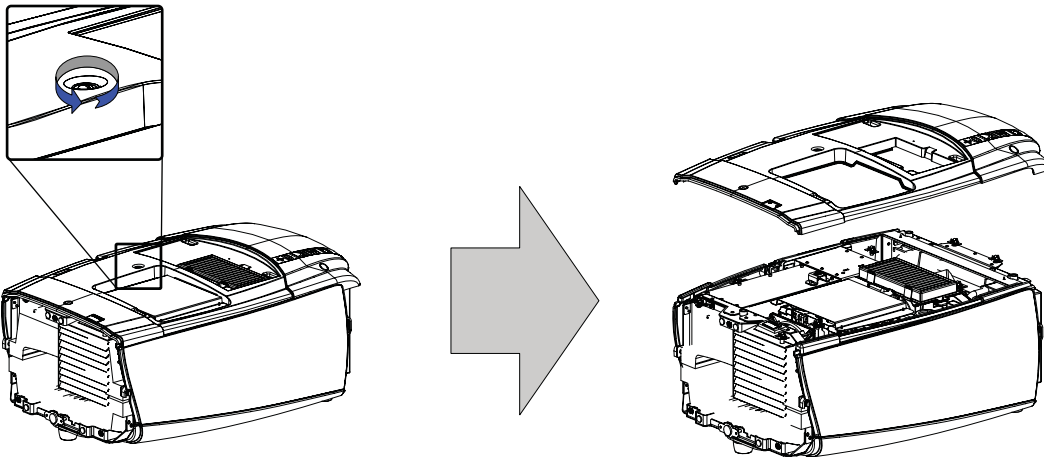

Image 17-7  
Remove top cover

2. Pull the cover out of its locks and take it off.

## 17.5 Removal of the side cover

---



To remove the side cover, first remove the front, back and top cover.

---

### Necessary tools

Flat screwdriver

### How to remove the side cover

1. Loosen both screws.

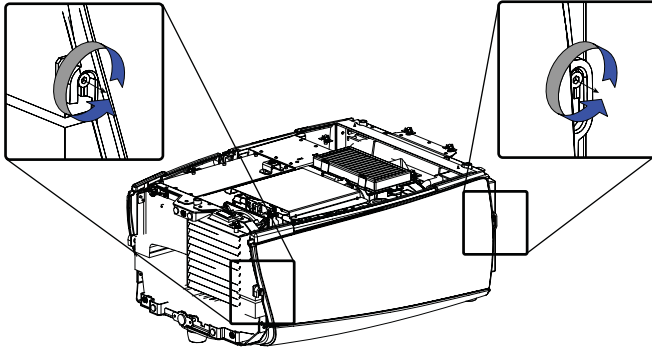

Image 17-8  
Loosen screws

2. Lift up the side cover and pull them forward to take off.

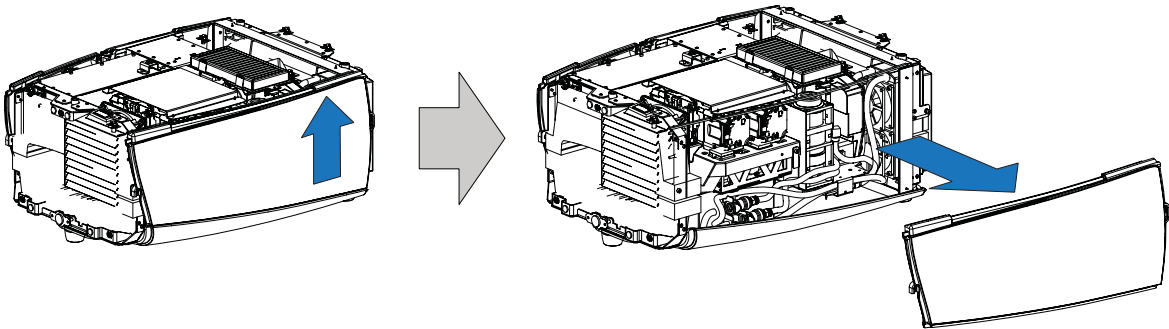

Image 17-9  
Side cover removal

## 17.6 Installation of the side cover

### Necessary tools

Allen wrench 3 mm

### How to install

1. Hook the side cover on the fixation screws and pull the cover downwards until it matches with the bottom cover.

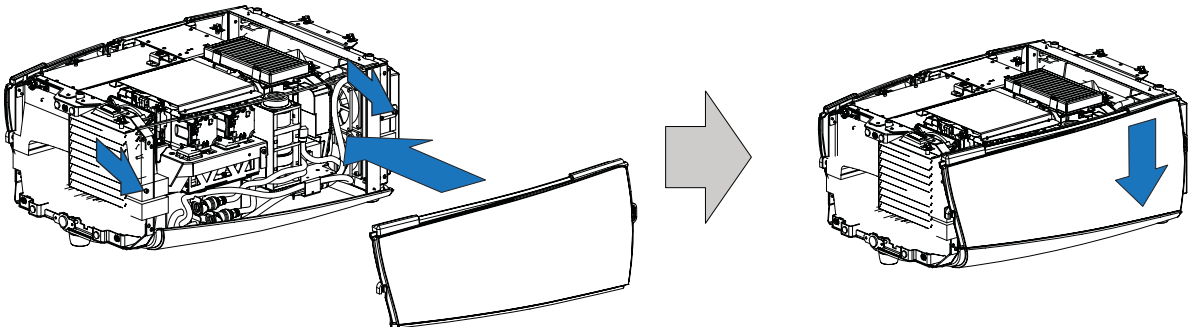

Image 17-10  
Mount side cover

2. Fixate both screws.

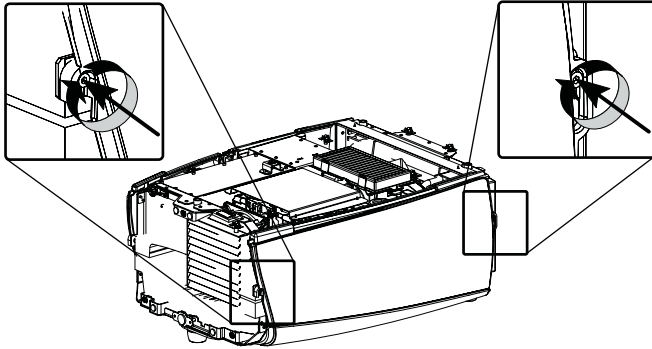

Image 17-11  
Fixate side cover

## 17.7 Installation of the top cover

---

### How to install

1. Place the top cover on the projector and push on the front side and back side of the cover until it clicks into its locks (4 locks).

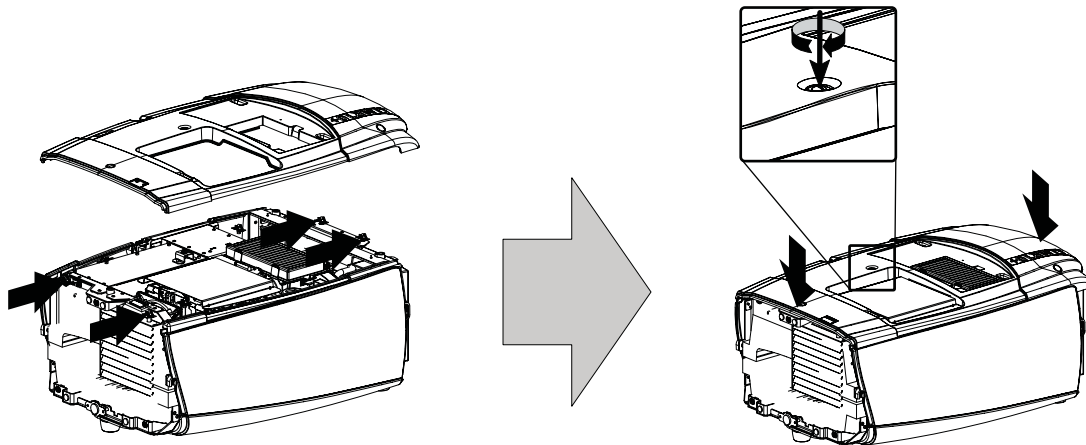

Image 17-12  
Mount top cover

2. Secure the cover by turning the captive screw clockwise.

## 17.8 Installation of the back cover

---

### How to install

1. Hook the back cover on the top and side covers so that the edges of all three covers are fixed in the back cover. No open space allowed between two covers.

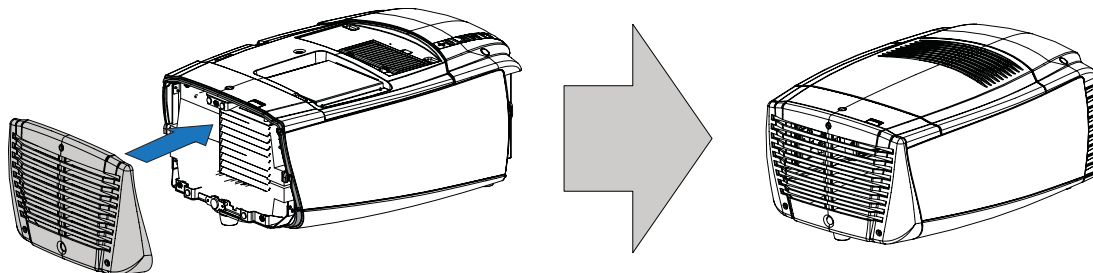

Image 17-13  
Mount back cover

2. Secure this position by turning the 3 captive screw clockwise.

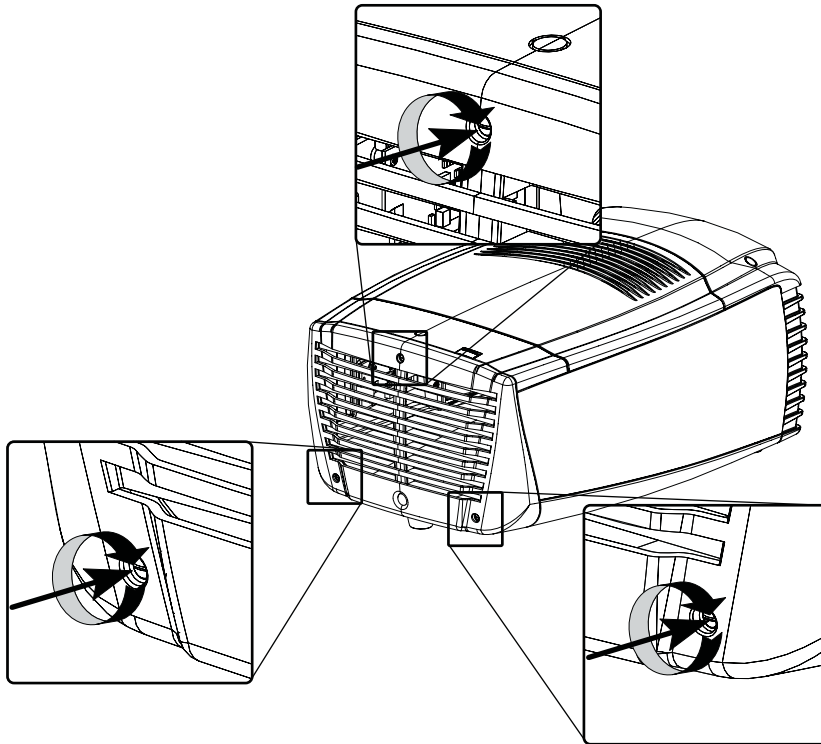

Image 17-14  
Secure back cover

## 17.9 Installation of the front cover



Front cover can only be installed after that the side covers and top cover are installed.

### Necessary tools

Flat screwdriver

### How to install the front cover

1. Insert the top of the front cover behind the front of the top cover (slant the cover a little bit before inserting (A) ).

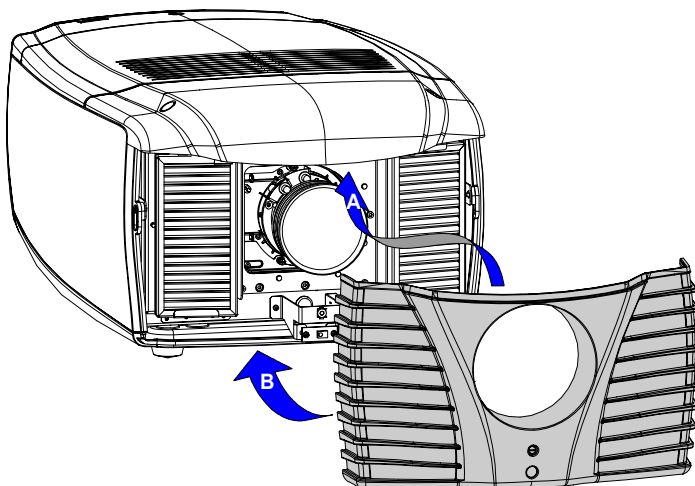

Image 17-15  
Install front cover

2. Pull the bottom side of the front cover toward the projector (B).  
The sides of the front cover overlap the sides of the side covers.

## 17. Projector covers, removal and installation

---

3. Fasten the captive screw at the middle bottom of the front cover (C).

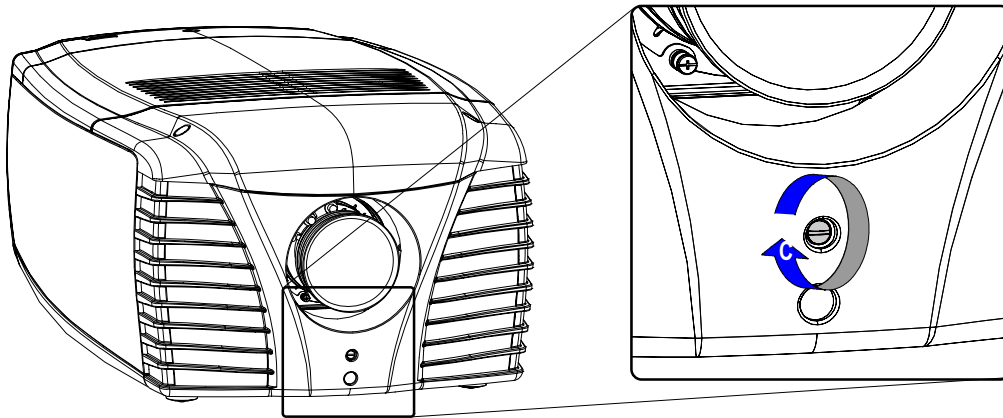

Image 17-16  
Secure front cover

### 17.10 Installation of the lamp door

---



Lamp door can only be installed when the top cover is installed.

---

#### Necessary tools

Flat screwdriver

#### How to install the lamp door

1. Place the lamp door with its pins (B) on its sockets (A) and push on it until clicks

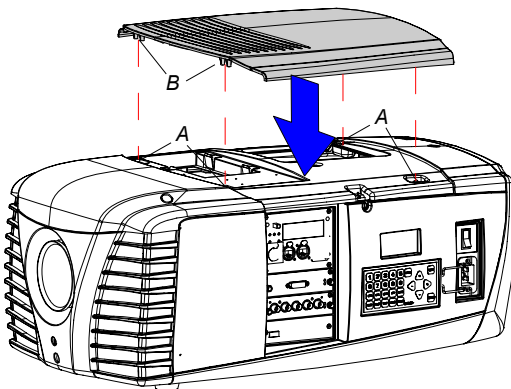

Image 17-17  
Lamp door installation

2. Fasten the captive screw at the middle upper side of the side cover on the input side.



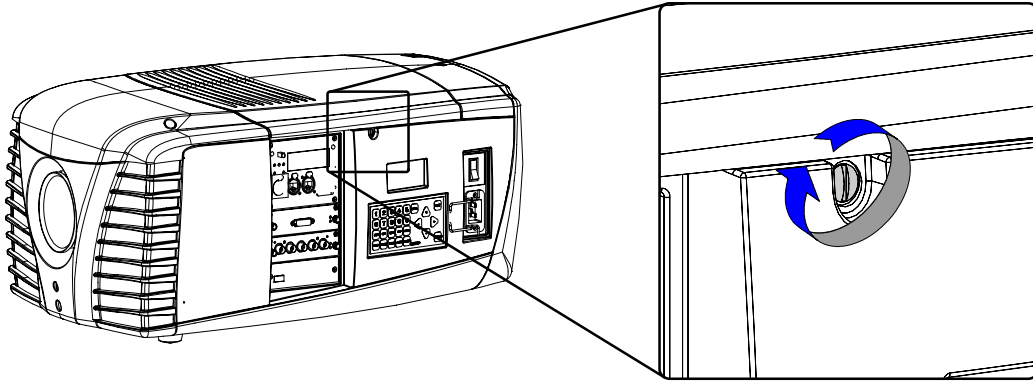

Image 17-18  
Secure the lamp door



# A. DIMENSIONS

## Overview

- Dimensions of the CLM HD8

## A.1 Dimensions of the CLM HD8

### Dimensions without carry handle

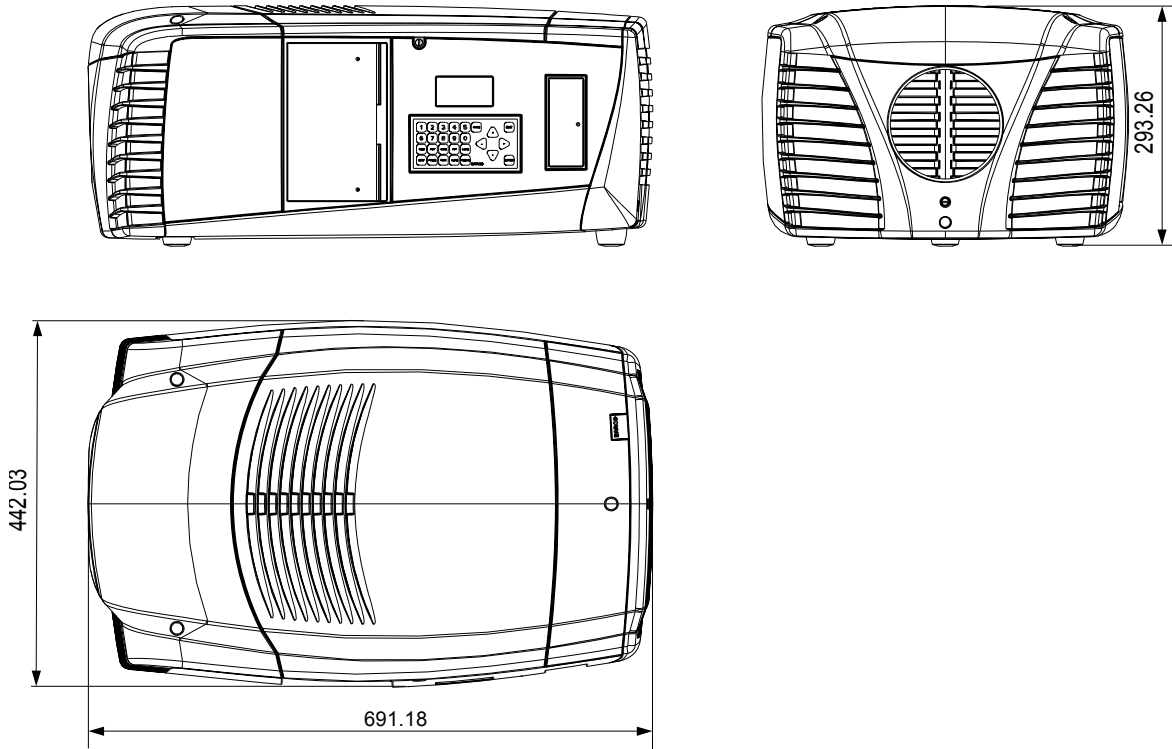

Image A-1  
Dimensions

Dimensions with optional carry handle

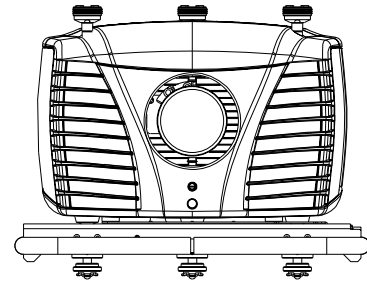
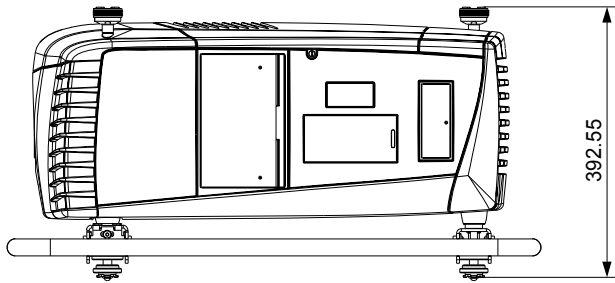
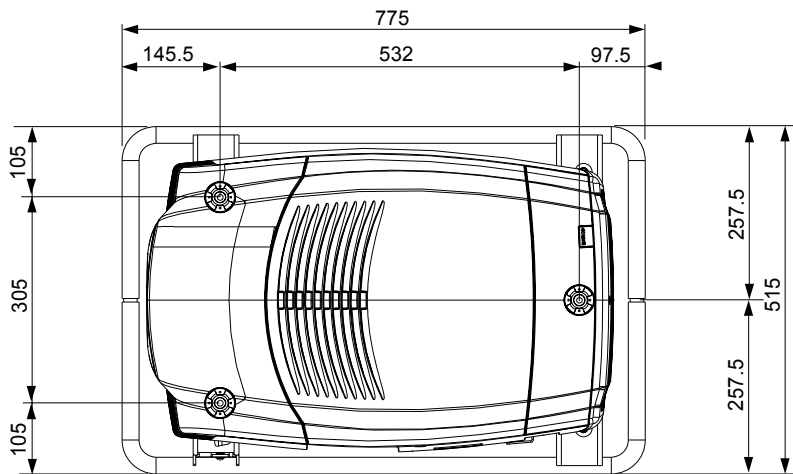

Image A-2

## B. STANDARD SOURCE FILES

### B.1 Table overview

#### Table overview

The following standard image files are pre-programmed in the projector.

Name <sup>1</sup>	Fvert Hz <sup>2</sup>	FHor kHz <sup>3</sup>	Fpix MHz <sup>4</sup>	Ptot <sup>5</sup>	Pact <sup>6</sup>	Ltot <sup>7</sup>	Lact <sup>8</sup>
640x350@85	85,079	37,860	31,500	832	640	445	350
640x400@85	85,079	37,860	31,500	832	640	445	400
640x480@60	59,940	31,668	25,175	800	640	525	480
640x480@72	72,888	30,288	19,687	832	640	520	480
640x480@75	74,999	37,500	31,500	840	640	500	480
640x480@85	85,009	43,270	36,000	832	640	509	480
720x400@85	85,040	37,928	35,500	936	720	446	400
800x600@56	56,251	35,157	36,001	1024	800	625	600
800x600@60	60,317	37,879	40,000	1056	800	628	600
800x600@72	72,188	48,077	50,000	1040	800	666	600
800x600@75	75,001	46,876	49,501	1056	800	625	600
800x600@85	85,062	53,674	56,250	1048	800	631	600
848x480@60	60,000	31,020	33,750	1088	848	517	480
1024x768@60	60,004	48,363	65,000	1344	1024	806	768
1024x768@70	70,068	56,475	74,999	1328	1024	806	768
1024x768@75	75,030	60,024	78,751	1312	1024	800	768
1024x768@85	84,996	68,677	94,499	1376	1024	808	768
1152x864@75	74,999	67,499	107,999	1600	1152	900	864
1280x768@60	59,870	47,776	79,499	1664	1280	798	768
1280x768@75	74,992	60,288	102,249	1696	1280	805	768
1280x768@85	84,838	68,634	117,502	1712	1280	809	768
1280x768RB@60	59,994	47,396	68,250	1440	1280	790	768
1280x960@60	59,999	59,999	107,998	1800	1280	1000	960
1280x960@85	85,005	85,940	128,505	1728	1280	1011	960
1280x1024@60	60,018	63,980	107,997	1688	1280	1066	1024
1280x1024@75	75,023	79,974	134,997	1688	1280	1066	1024
1280x1024@85	85,027	91,149	157,506	1728	1280	1072	1024
1360x768@60	59,898	47,619	85,333	1792	1360	795	768
1400x1050@50	50,015	54,517	94,641	1736	1400	1090	1050
1400x1050@60	59,979	65,317	121,751	1864	1400	1089	1050
1400x1050@75	74,866	82,277	155,998	1896	1400	1099	1050
1400x1050@85	84,958	93,879	179,497	1912	1400	1105	1050

1. Name: name of file, contains the settings.
2. Fvert Hz: vertical frame frequency of the source
3. FHor kHz: horizontal frequency of the source
4. Fpix MHz: pixel frequency
5. Ptot : total pixels on one horizontal line.
6. Pact: active pixels on one horizontal line.
7. Ltot: total lines in one field
8. Lact: active lines in one field.

B. Standard Source Files

Name <sup>1</sup>	Fvert Hz <sup>2</sup>	FHor kHz <sup>3</sup>	Fpix MHz <sup>4</sup>	Ptot <sup>5</sup>	Pact <sup>6</sup>	Ltot <sup>7</sup>	Lact <sup>8</sup>
1400x1050RB@60	59,946	64,742	100,997	1560	1400	1080	1050
1600x1200@60	60,001	75,002	162,004	2160	1600	1250	1200
1600x1200@65	64,998	81,248	175,496	2160	1600	1250	1200
1600x1200@70	69,997	87,497	188,993	2160	1600	1250	1200
1600x1200@75	74,998	93,747	202,414	2160	1600	1250	1200
1600x1200@85	84,998	106,247	229,494	2160	1600	1250	1200
1792x1344@60	60,000	83,640	204,751	2448	1792	1394	1344
1792x1344@75	74,996	106,270	260,999	2456	1792	1417	1344
1856x1392@60	59,995	86,333	218,251	2528	1856	1439	1392
1920x1140@60	60,001	90,001	234,002	2600	1920	1500	1140
1920x1200@60	59,883	74,555	193,235	2592	1920	1245	1200
1920x1200RB@60	59,952	74,041	154,006	2080	1920	1235	1200
1920x1440@60	60,001	90,001	234,002	2600	1920	1500	1200
hd-1280x720@60p	60,001	45,000	74,251	1650	1280	750	720
hd-1920x1035@30i	60,000	33,720	74,184	2200	1920	562	517
hd-1920x1080@24p	24,000	27,000	74,250	2750	1920	1125	1080
hd-1920x1080@24sf	48,001	54,002	148,504	2750	1920	1125	1080
hd-1920x1080@25i	50,044	28,125	74,249	2640	1920	562	540
hd-1920x1080@25p	25,000	28,125	74,249	2640	1920	1125	1080
hd-1920x1080@30i	60,000	33,720	74,184	2200	1920	562	540
hd-1920x1080@30p	30,000	33,750	74,249	2200	1920	1125	1080
hd-1920x1080@25i	50,000	31.25	74,250	2376	1920	625	540
hd-1920x1080@60p	60,011	67,513	148,528	2200	1920	1125	1080
VIDEO525	62,437	15,734	13,500	858	712	252	242
VIDEO525p	59,940	31,468	27,000	858	712	525	484
VIDEO625	50,080	15,625	13,500	864	702	312	287
VIDEO625p	50,080	31,250	27,000	864	702	625	574
no-signal	100,00	20,000	8,000	400	300	200	100
no-signal-i	100,00	20,000	8,000	400	300	200	100

Table B-1

## C. DMX CHART

### Overview

- CLM control channel mapping (Full mode)
- CLM control channel mapping (Basic mode)

### C.1 CLM control channel mapping (Full mode)

#### Overview

Channel	Function	Type	Range	Default	Action	Comments
1	Intensity	Xfade	0 - 255		0 - 100%	
2	Brightness	Xfade	0 - 255	128	0 - 100%	The value is + / - so the value needs to be 128 to be "Normal"
3	Contrast	Xfade	0 - 255	128	0 - 100%	The value is + / - so the value needs to be 128 to be "Normal"
4	Input Select		0 - 7	0	No function	
			8 - 15		Layout Main Full Screen	
			16 - 23		Layout PiP top right	
			24 - 31		Layout Split left - right	
			32 - 39		Layout Split top - bottom	
			40 - 47		Layout 5	
			48 - 55		Layout 6	
			56 - 63		Layout 7	
			64 - 71		Layout 8	
			72 - 79		Layout 9	
			80 - 87		Layout 10	
			88 - 95		Input 1	
			96 - 103		Input 2	
			104 - 111		Input 3	Not for CLM
	112 - 119		Input 4	Not for CLM		
	120 - 255		Future assignment			
5	Function Select		0 - 31		No function	
			31 - 63		Focus motor	
			64 - 95		Zoom motor	
			96 - 127		Lens R - L	
			128 - 159		Lens Up - Down	
			160 - 191		Power On / Lamp On	Together with both Motor Go channels (channel 6 & 7) held in 255 for 5 seconds.
			192 - 223		Stand By / Lamp off	Together with both Motor Go channels (channel 6 & 7) held in 255 for 5 seconds.
			224 - 255		Future assignment	

C. DMX Chart

Channel	Function	Type	Range	Default	Action	Comments
6	Motor Go >>		0 - 31		Stop	
			31 - 63		Run	
			64 - 95		Future assignment	Same as Stop
			96 - 127		Future assignment	Same as Stop
			128 - 159		Future assignment	Same as Stop
			160 - 191		Future assignment	Same as Stop
			192 - 223		Future assignment	Same as Stop
			224 - 255		Activates Function Channels Command	Held for 5 seconds
7	Motor Go <<		0 - 31		Stop	
			31 - 63		Run	
			64 - 95		Future assignment	Same as Stop
			96 - 127		Future assignment	Same as Stop
			128 - 159		Future assignment	Same as Stop
			160 - 191		Future assignment	Same as Stop
			192 - 223		Future assignment	Same as Stop
			224 - 255		Activates Function Channels Command	Held for 5 seconds
8	White peaking		0 - 255		100 - 0%	Inverted to avoid bad reproduction, action needed to remove white peaking.
9	Lamp Power		0 - 26	0	100%	Inverted to avoid bad reproduction, action needed to dim down the power.
			27 - 52		98%	
			53 - 79		96%	
			80 - 105		94%	
			105 - 131		91%	
			132 - 157		89%	
			158 - 183		86%	
			184 - 209		84%	
			210 - 235		82%	
			236 - 255		80%	
10	Free		0 - 255		Reserved for Future expansion	

C.2 CLM control channel mapping (Basic mode)

Overview

Channel	Function	Type	Range	Default	Action	Comments
1	Dimmer	Xfade	0 - 255		0 - 100%	



Channel	Function	Type	Range	Default	Action	Comments
2	Function Select		0 - 7		No function	
			8 - 15		Activate Layout 1 (Main full screen)	If held for 2 Sec
			16 - 23		Activate Layout 2 (PiP top right)	If held for 2 Sec
			24 - 31		Activate Layout 3 (Split top - bottom)	If held for 2 Sec
			32 - 39		Activate Layout 4 (Split left - right)	If held for 2 Sec
			40 - 47		Activate Layout 5	If held for 2 Sec
			48 - 55		Activate Layout 6	If held for 2 Sec
			56 - 63		Activate Layout 7	If held for 2 Sec
			64 - 71		Activate Layout 8	If held for 2 Sec
			72 - 79		Activate Layout 9	If held for 2 Sec
			80 - 87		Activate Layout 10	If held for 2 Sec
			88 - 95		Input 1	If held for 2 Sec
			96 - 103		Input 2	If held for 2 Sec
			104 - 111		Input 3	If held for 2 Sec (Not for CLM)
			112 - 119		Input 4	If held for 2 Sec (Not for CLM)
			120 - 207		Future assignment	
			208 - 215		Power On / Lamp On	If held for 2 Sec
			216 - 223		Stand By / Lamp Off	If held for 2 Sec
			224 - 255		Future assignment	Future assignment



## D. SPECIFICATIONS

### Overview

- Specifications CLM HD8
- Specifications CLM 5 cable input (multi purpose)
- Specifications CLM HDSDI – SDI input
- Specifications CLM DVI input
- Specifications CLM DVI HDCP input

### D.1 Specifications CLM HD8

#### Overview

<b>Ambient temperature</b>	Max. 40°C (104°F)
<b>Brightness uniformity</b>	95%
<b>Communication</b>	<ul style="list-style-type: none"> <li>• 1x RS-232C/RS-422 IN (D-9 connector)</li> <li>• 1x RS-232C/RS-422 OUT (D-9 connector)</li> <li>• 1x RS-232C IN (XLR connector)</li> </ul>
<b>Compatibility</b>	<ul style="list-style-type: none"> <li>• All current video sources (PAL, SECAM, NTSC) in Composite, S-VHS, Component or RGB formats</li> <li>• All currently proposed HDTV, extended and improved television standards (1080i, 720p)</li> <li>• All computer graphics formats from VGA, SVGA, XGA, SXGA, full HD to UXGA</li> <li>• Most Macintosh computers</li> <li>• Electronic workstations with a resolution up to 1600 x 1200 pixels at 75 Hz</li> <li>• Most computer sources with a pixel clock up to 200 MHz</li> <li>• DVI sources up to SXGA+</li> </ul>
<b>Contrast ratio</b>	1200:1 (full field) High contrast mode: Contrast enhancement by optical dowsler
<b>Dimensions</b>	W x L x H 692 x 442 x 293 mm 27.24 x 17.40 x 11.54 inch (excl. carrying handle + rigging points)
<b>Display</b>	1 Chip DLP HD (resolution 1920*1080(aspect 16/9))
<b>Dust filters</b>	High density filters
<b>Electromagnetic Interference</b>	Complies with FCC rules & regulations, part 15 Class A and CE EN55022 Class A
<b>Features</b>	<ul style="list-style-type: none"> <li>• DMX512 control of optical dimming, electronic dimming, zoom, focus, lens shift, input select</li> <li>• Advanced picture-in-picture</li> <li>• Seamless switching with effects</li> <li>• Carry handle/frame</li> <li>• Rigging points (touring kit)</li> <li>• Flexible positioning (portrait/ landscape/any setup possible)</li> <li>• Brilliant Color processing</li> </ul>
<b>Heat dissipation</b>	BTU 5500
<b>Input source compatibility</b>	max. input resolution up to UXGA (1,600 x 1,200) and HD (1,920 x 1,080)

D. Specifications

<b>Inputs</b>	<b>Standard inputs:</b> <ul style="list-style-type: none"> <li>• configurable 5 cable (BNC)</li> <li>• SDI/HD-SDI</li> </ul>
<b>Lamp</b>	4 x 300 W Lamp warranty: 750 Hrs max lamp life 1250hrs: operates 1,2,4 lamps
<b>Lens Shift</b>	Vertical: -20% to +110% Horizontal: 15% to -100% (small differences occur per lens type) Note: no lens shift on QCLD lenses.
<b>Lenses</b>	Zoom lens CLD 1.2 - 1.5:1 Zoom lens CLD 1.5 - 2.2:1 Zoom lens CLD 2.2 - 4.4:1 Zoom lens CLD 4.4 - 7.0:1 Wide lens QCLD 0.85:1
<b>Light Output</b>	8000 Center Lumen >7500 ANSI Lumen
<b>Mains Voltage</b>	100 - 240 V / 50 - 60 Hz
<b>Network connection</b>	10/100 Base-T, RJ-45 connection Optical dowser (dimmer): 0 - 100% brightness control by DMX512 signal Projector toolset control program included
<b>Noise Level</b>	49 dB(A) at 25°C
<b>Order Information</b>	HD 8 R9050130 HD 8 with touring kit R90501301 R10+ R9050100 R10+ with touring kit R90501001 Touring kit = frame/ carry handle + clamps + ruggedized remote + stacking points
<b>Picture-in-picture</b>	two sources simultaneously
<b>Power consumption</b>	Max 1600 watt
<b>Resolution</b>	1920 x 1080 (full HD)
<b>Safety Regulations</b>	EN 60950-1 ( for Europe) UL 60950-1 (for USA)
<b>ScenergiX</b>	horizontal and vertical electronic edge blending
<b>Sealed DLP™ core</b>	Standard
<b>Weight</b>	31 kg excl. lens and rigging frame

## D.2 Specifications CLM 5 cable input (multi purpose)

### Front view 5 cable input

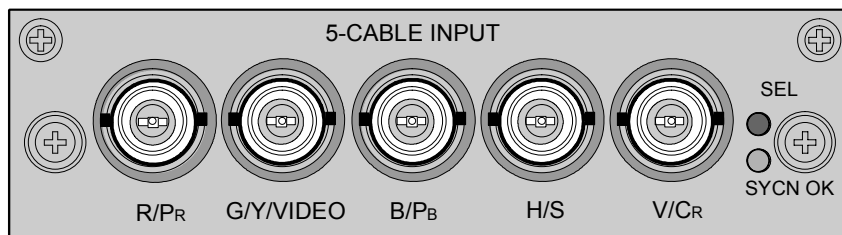

Image D-1

### Signal connectivity

Input signal	R / P <sub>R</sub>	G / Y / VIDEO	B / P <sub>B</sub>	H / S	V / C <sub>R</sub>
RGBHV	R	G	B	H	V
RGBS	R	G	B	S	—
				composite sync or VIDEO as sync	
RGsB	R	Gs	B	—	—
		sync on green			
Composite Video	—	VIDEO	—	—	—
Super Video	—	Y	—	—	C
		Luma			Chroma
Component Video - SS	P <sub>R</sub> / (R - Y)	Y	P <sub>B</sub> / (B - Y)	S	—
				composite sync or VIDEO as sync	
Component Video - SOY	P <sub>R</sub> / (R - Y)	Ys	P <sub>B</sub> / (B - Y)	—	—

### Specifications

- Data and HD sources RGB and YUV [HS/VS, CS or SOG(Y)]:
  - Pixel clock maximum 275 MHz
  - 8 bit digital output
- Video sources CVBS, S-VIDEO, RGB and YUV [CS, CV or SOG(Y)]:
  - PAL B/D/I/G/H, PAL60, PAL M, PAL N, PAL Nc
  - NTSC M/J, NTSC 4.43
  - SECAM B/D/G/K/L
  - 525i, 625i, 525p, 625p
  - Macrovision copy protection robust
  - 10 bit digital output
  - Standard images "video525" and "video625"
- Automatic detection of sync inputs but with manual override:
  - automatic modes : RGB, YUV, VIDEO
  - manual modes : RGB HS/VS - CS, RGB CV, RGB SOG, YUV HS/VS - CS, YUV CV, YUV SOY, CVBS, S-VIDEO
- Possible to disconnect 75 Ohm terminations on HS and VS (TTL sync level selection)
- Signal requirements:
  - Component Video (BNC)
    - o R-Y : 0,7Vpp ±3dB 75 Ohm termination.
    - o Ys : 1Vpp ±3dB (0,7V Luma +0,3V Sync) 75 Ohm termination.
    - o B-Y : 0,7Vpp ±3dB 75 Ohm termination.
  - RG(s)B
    - o R : 0,7Vpp ±3dB 75 Ohm termination.
    - o G(s) : 1Vpp ±3dB (0,7Vpp G + 0,3Vpp Sync) 75 Ohm termination.
    - o B : 0,7Vpp ±3dB 75 Ohm termination.

- Diagnostic LED's on front panel:
  - Green LED: Lights up in case input module is selected
  - Yellow LED: Lights up in case sync detected

### D.3 Specifications CLM HDSDI – SDI input

---

#### Input front view HDSDI – SDI input

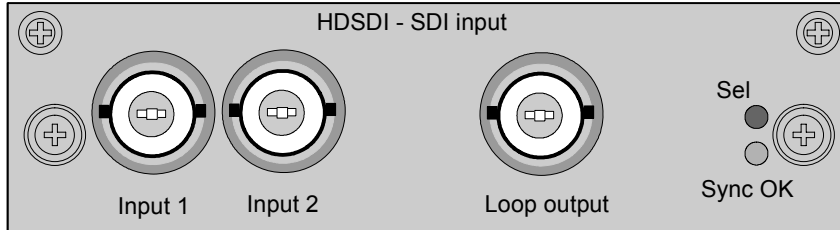

Image D-2

#### Specifications

- SD SMPTE 259M-C and HD SMPTE 292M input data
- 2 inputs (BNC), 1 active loop-through output (BNC) of selected input
- Automatic selection of active input with manual override
- 10 bit digital output
- Diagnostic LED's on front panel:
  - Green LED: Lights up in case input module is selected
  - Yellow LED: Lights up in case sync detected
- SDI: 270 Mbit/s transmission (SMPTE 259M-C).
- SDI: 525/625 interlaced.
- Coax (75 Ohm).
- Supported HDSDI standards:
  - Progressive:
    - o 1280x720/60/1:1/ (SMPTE 296M)
    - o 1280x720/59.94/1:1/ (SMPTE 296M)
    - o 1920x1080/30/1:1/ (SMPTE 274M)
    - o 1920x1080/29.97/1:1/ (SMPTE 274M)
    - o 1920x1080/25/1:1/ (SMPTE 274M)
    - o 1920x1080/24/1:1/ (SMPTE 274M)
    - o 1920x1080/23.98/1:1/ (SMPTE 274M)
  - Interlaced:
    - o 1920x1035/60/2:1/ (SMPTE 260M)
    - o 1920x1035/59.94/2:1/ (SMPTE 260M)
    - o 1920x1080/60/2:1/ (SMPTE 274M)
    - o 1920x1080/59.94/2:1/ (SMPTE 274M)
    - o 1920x1080/50/2:1/ (SMPTE 274M)
    - o 1920/1080/50/2:1 (1250)/ (SMPTE 295M)
    - o 1920x1080/24/Segmented/ (SMPTE 274M)
    - o 1920x1080//23.98/Segmented/ (SMPTE 274M)

## D.4 Specifications CLM DVI input

### Input front view

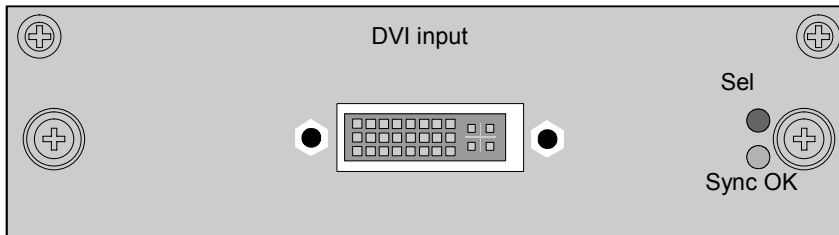

Image D-3

### Specifications

- DVI type: DVI-I (DVI-Integrated), but the analog signals are not supported. Single-link configuration.
- Single link dvi for pixelclocks up to 165MHz
- Vertical frequencies: 24 - 75 Hz
- Horizontal frequencies: 20 - 90 kHz
- Supported resolutions: up to UXGA (1600 x 1200) at 60 Hz.
- Cable lengths: up to 3 meter at UXGA speed.
- Compliance: DDC2B support according to VESA EDID Version 1.2
- Diagnostic LED's on front panel:
  - Green LED: Lights up in case input module is selected
  - Yellow LED: Lights up in case sync detected

## D.5 Specifications CLM DVI HDCP input

### Input front view

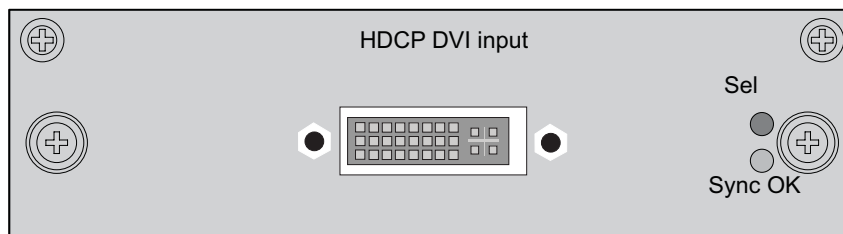

Image D-4

### Specifications

- DVI type: DVI-I (DVI-Integrated), but the analog signals are not supported. Single-link configuration.
- Supports UXGA Resolution (1600 x 1200) (Output Pixel Rates up to 165 MHz)
- True-Color, 24 Bits/Pixel, 48-Bit Dual Pixel Output Mode, 16.7M Colors at 1 or 2 Pixels Per Clock
- Digital Visual Interface (DVI) and High-Bandwidth Digital Content Protection (HDCP) Specification Compliant
- Vertical frequencies: 24 - 75 Hz
- Horizontal frequencies: 20 - 90 kHz
- Cable lengths: up to 3 meter at UXGA speed.
- Compliance: DDC2B support according to VESA EDID Version 1.2
- Diagnostic LED's on front panel:
  - Green LED: Lights up in case input module is selected
  - Yellow LED: Lights up in case sync detected





# E. TROUBLESHOOTING

## E.1 Error codes

### Overview

When the error code is preceded by a '-' sign, then the error means a real error for the projector.

When the error code is preceded by a '+' sign, then the error code means a warning. The projector does not fail yet, but take care for the warning and try to resolve the problem. A warning state can turn into an error state.

Not all error codes can have two states. When the state is available, it is indicated by a Yes in the overview table. When the state is not available, it is indicated by a No.

Error code	Description	Error	Warning	Caused by	Action
1001	Wrong lamp 1 parameters	Yes	-	Wrong lamp/ no communication with lamp	Check lamp type Call a qualified service engineer
1002	Wrong lamp 2 parameters	Yes	-	Wrong lamp/ no communication with lamp	Check lamp type Call a qualified service engineer
1003	Wrong lamp 3 parameters	Yes	-	Wrong lamp/ no communication with lamp	Check lamp type Call a qualified service engineer
1004	Wrong lamp 4 parameters	Yes	-	Wrong lamp/ no communication with lamp	Check lamp type Call a qualified service engineer
1011	Lamp 1 missing	Yes	Yes	No lamp inserted in position 1	Insert a lamp in position 1
1012	Lamp 2 missing	Yes	Yes	No lamp inserted in position 2	Insert a lamp in position 2
1013	Lamp 3 missing	Yes	Yes	No lamp inserted in position 3	Insert a lamp in position 3
1014	Lamp 4 missing	Yes	Yes	No lamp inserted in position 4	Insert a lamp in position 4
1021	Lamp 1 broken	Yes	-	Lamp 1 is not ON	Check installation of lamp 1 (connection, cable, etc.)
1022	Lamp 2 broken	Yes	-	Lamp 2 is not ON	Check installation of lamp 2 (connection, cable, etc.)
1023	Lamp 3 broken	Yes	-	Lamp 3 is not ON	Check installation of lamp 3 (connection, cable, etc.)
1024	Lamp 4 broken	Yes	-	Lamp 4 is not ON	Check installation of lamp 4 (connection, cable, etc.)
1399	I <sup>2</sup> C open error	Yes			
1398	I <sup>2</sup> C read error	Yes			
1397	I <sup>2</sup> C write error	Yes			
1699	Formatter busy				
1697	Formatter init failed	Yes	-	no communication with formatter ctrl	Call a qualified service engineer
1696	Formatter ctrl init failed	Yes	-	no communication with formatter ctrl	Call a qualified service engineer
1695	Formatter start failed	Yes	-	no communication with formatter	Call a qualified service engineer
1693					
1692					
1691					
2100	LPS 1 error	Yes	-		Replace LPS
2400	LPS 2 error	Yes	-		Replace LPS
2700	LPS 3 error	Yes	-		Replace LPS
3000	LPS 4 error	Yes	-		Replace LPS

E. Troubleshooting

Error code	Description	Error	Warning	Caused by	Action
4198	FPGA PMP init failed	Yes	-		
6099	Board ID unkown version	Yes			
6098	Board ID invalid string	Yes			
7999	DMD temp low	Yes	Yes	Low temperature on DMD	turning on the lamp(s) will heat up the DMD
7998	DMD temp high	Yes	Yes	High temperature on DMD	check if air slots are free, clean air filters. If problem persists, call a qualified service engineer.
7997	Ambient temp low	Yes	Yes	Ambient temperature out of specifications	take measurements to increase the temperature
7996	Ambient temp high	Yes	Yes	Ambient temperature out of specifications	check ambient conditions check if air slots are free, clean air filter.
7995	TEC temp low				
7994	TEC temp high	Yes	Yes		
7992	LPS1 temp high	Yes	Yes	High temperature on LPS1	check if air slots are free, clean air filters. If problem persists, call a qualified service engineer.
7990	LPS2 temp high	Yes	Yes	High temperature on LPS2	check if air slots are free, clean air filters. If problem persists, call a qualified service engineer.
7988	LPS3 temp high	Yes	Yes	High temperature on LPS3	check if air slots are free, clean air filters. If problem persists, call a qualified service engineer.
7986	LPS4 temp high	Yes	Yes	High temperature on LPS4	check if air slots are free, clean air filters. If problem persists, call a qualified service engineer.
7978	Lamp4 temp high	Yes	Yes	High temperature on lamp 4	check if air slots are free, clean air filters. If problem persists, call a qualified service engineer.
7924	Fan radiator A low	Yes	Yes	Fan is running too slow or not at all	If problem persists, call a qualified service engineer
7922	Fan radiator B low	Yes	Yes	Fan is running too slow or not at all	If problem persists, call a qualified service engineer
7920	Fan outlet A low	Yes	Yes	Fan is running too slow or not at all	If problem persists, call a qualified service engineer
7918	Fan outlet B low	Yes	Yes	Fan is running too slow or not at all	If problem persists, call a qualified service engineer
7916	Fan power supply A low	Yes	Yes	Fan is running too slow or not at all	If problem persists, call a qualified service engineer
7914	Fan power supply B low	Yes	Yes	Fan is running too slow or not at all	If problem persists, call a qualified service engineer
7912	Fan LPS A low	Yes	Yes	Fan is running too slow or not at all	If problem persists, call a qualified service engineer
7910	Fan LPS B low	Yes	Yes	Fan is running too slow or not at all	If problem persists, call a qualified service engineer

Error code	Description	Error	Warning	Caused by	Action
7908	Fan inlet A low	Yes	Yes	Fan is running too slow or not at all	If problem persists, call a qualified service engineer
7906	Fan inlet B low	Yes	Yes	Fan is running too slow or not at all	If problem persists, call a qualified service engineer
7904	Fan lamp 1 back low	Yes	Yes	Fan is running too slow or not at all	If problem persists, call a qualified service engineer
7902	Fan lamp 2 back low	Yes	Yes	Fan is running too slow or not at all	If problem persists, call a qualified service engineer
7900	Fan lamp 3 back low	Yes	Yes	Fan is running too slow or not at all	If problem persists, call a qualified service engineer
7899	Fan lamp 3 back high	-	Yes		
7898	Fan lamp 4 back low	Yes	Yes	Fan is running too slow or not at all	If problem persists, call a qualified service engineer
7896	Fan prism low	Yes	Yes	Fan is running too slow or not at all	If problem persists, call a qualified service engineer
7894	Fan color wheel low	Yes	Yes	Fan is running too slow or not at all	If problem persists, call a qualified service engineer
7892	Fan lamp 1 front low	Yes	Yes	Fan is running too slow or not at all	If problem persists, call a qualified service engineer
7890	Fan lamp 2 front low	Yes	Yes	Fan is running too slow or not at all	If problem persists, call a qualified service engineer
7888	Fan lamp 3 front low	Yes	Yes	Fan is running too slow or not at all	If problem persists, call a qualified service engineer
7886	Fan lamp 4 front low	Yes	Yes	Fan is running too slow or not at all	If problem persists, call a qualified service engineer
7884	Pump speed low	Yes	Yes	Bad or no water flow in the cooling circuit	If problem persists, call a qualified service engineer
7883	Pump speed high	-	Yes		Ignore this message
7878	Over temp	Yes	Yes	extreme overheating of DMD or lamps	If problem persists, call a qualified service engineer
7877	Under temp			DMD too cold	Warm up the projector
7876	SMPS input range			Supplied voltage is out of range	Check supplied voltage range
7875	DMD temp open	Yes	Yes	Sensor not connected	If problem persists, call a qualified service engineer
7874	DMD temp short	Yes	Yes	short circuit in sensor circuit	If problem persists, call a qualified service engineer
7873	Ambient temp open	Yes	Yes	Sensor not connected	If problem persists, call a qualified service engineer
7872	Ambient temp short	Yes	Yes	short circuit in sensor circuit	If problem persists, call a qualified service engineer
7871	TEC temp open	Yes	Yes	Sensor not connected	If problem persists, call a qualified service engineer
7870	TEC temp short	Yes	Yes	short circuit in sensor circuit	If problem persists, call a qualified service engineer
7865	Lamp 1 run time msg exceeded	-	Yes	Run time of lamp 1 will be exceeded	Replace the lamp with a new one. Call a qualified service engineer
7864	Lamp 1 run time warning exceeded	-	Yes	Run time of lamp 1 is exceeded	Replace the lamp with a new one. Call a qualified service engineer
7863	Lamp 1 run time max exceeded	-	Yes	The maximum run time for the lamp is exceeded	Replace the lamp with a new one. Call a qualified service engineer

E. Troubleshooting

Error code	Description	Error	Warning	Caused by	Action
7862	Lamp 1 run time shtdwn exceeded	-	Yes		
7861	Lamp 2 run time msg exceeded	-	Yes	Run time of lamp 2 will be exceeded	Replace the lamp with a new one. Call a qualified service engineer
7860	Lamp 2 run time warning exceeded	-	Yes	Run time of lamp 2 is exceeded	Replace the lamp with a new one. Call a qualified service engineer
7859	Lamp 2 run time max exceeded	-	Yes	The maximum run time for the lamp is exceeded	Replace the lamp with a new one. Call a qualified service engineer
7858	Lamp 2 run time shtdwn exceeded	-	Yes		
7857	Lamp 3 run time msg exceeded	-	Yes	Run time of lamp 3 will be exceeded	Replace the lamp with a new one. Call a qualified service engineer
7856	Lamp 3 run time warning exceeded	-	Yes	Run time of lamp 3 is exceeded	Replace the lamp with a new one. Call a qualified service engineer
7855	Lamp 3 run time max exceeded	-	Yes	The maximum run time for the lamp is exceeded	Replace the lamp with a new one. Call a qualified service engineer
7854	Lamp 3 run time shtdwn exceeded	-	Yes		
7853	Lamp 4 run time msg exceeded	-	Yes	Run time of lamp 4 will be exceeded	Replace the lamp with a new one. Call a qualified service engineer
7852	Lamp 4 run time warning exceeded	-	Yes	Run time of lamp 4 is exceeded	Replace the lamp with a new one. Call a qualified service engineer
7851	Lamp 4 run time max exceeded	-	Yes	The maximum run time for the lamp is exceeded	Replace the lamp with a new one. Call a qualified service engineer
7850	Lamp 4 run time shtdwn exceeded	-	Yes		
7600	Color wheel not spinning	Yes	Yes		If problem persists, call a qualified service engineer
7500	Failed to set FCB mode				
7499	FCB time out				
7498	FCB I2C				
7497	FCB parameters				
7496	FCB monitoring				
8000	Opening shutter failed	No	Yes		If problem persists, call a qualified service engineer
8001	Closing shutter failed	No	Yes		If problem persists, call a qualified service engineer
8002	Failed reading lamp info mode	No	Yes		If problem persists, call a qualified service engineer
9199	Scaler unit failed	Yes	-	Initialization of the scaler failed	If problem persists, call a qualified service engineer
9198	Scaler pixel clock too high	Yes	-	BW or refresh rate of input source too high	

Error code	Description	Error	Warning	Caused by	Action
9399	Error image				
9398	Maximum image files reached	Yes	No	Reaching the maximum allowed number of files	Delete some unnecessary files
10499	Error input				
10498	Unsupported module	Yes	No	Module with obsolete firmware	Call a qualified service engineer
10497	Init DVI input failed	Yes			Check DVI input module and input source If problem persists, call a qualified service engineer
27999	OSD no font	Yes			Call a qualified service engineer
27998	OSD font error	Yes			Call a qualified service engineer
27997	OSD memory	Yes			Call a qualified service engineer
27996	OSD out of range	Yes			Call a qualified service engineer
27995	OSD out of pos.	Yes			Call a qualified service engineer
27994	OSD fifo full	Yes			Call a qualified service engineer



## F. MOUNTING OPTIONAL CARRY HANDLE

### About this chapter

This chapter describes the procedures to mount the optional carry handle to CLM projector. When this optional carry handle is mounted, the projector can be suspended with the rigging clamps and stacking of projector is possible.

### Overview

- Mounting stacking points on top cover
- Preparing the new carry handle
- Preparing the projector
- Mounting the carry handle



**CAUTION:** While mounting the carrying handle, save the removed bolts.

When removing a mounted carrying handle again and mounting the original feet back, always use the original bolts (M10x16) !

Never use the bolts which are used to mount the carrying handle. These bolts will damage the heat exchanger with a cooling liquid leakage as result.



Image F-1

### F.1 Mounting stacking points on top cover

#### Why mounting the stacking points ?

The stacking points must be mounted for the following reasons:

- To turn the projector upside down and place it on the top cover.
- To stack two projectors on each other.

#### How to mount the stacking points

1. Break out the circular holes in the top cover.

## F. Mounting optional Carry handle

---

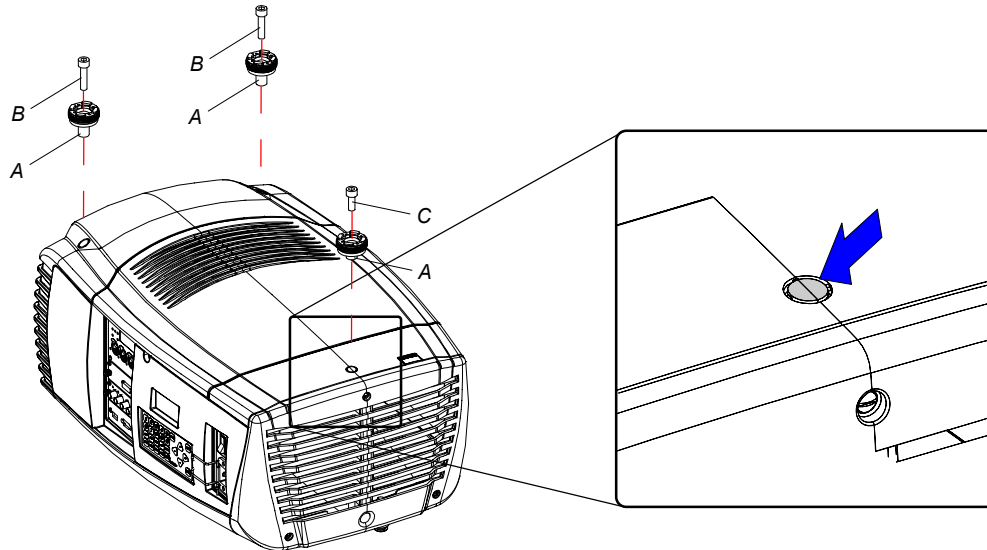

Image F-2  
Mounting the stacking points

2. Place a stacking point (A) in each hole.
3. For the front stacking points, turn in for each a long bolt (B). For the back stacking point, turn in a short bolt (C).

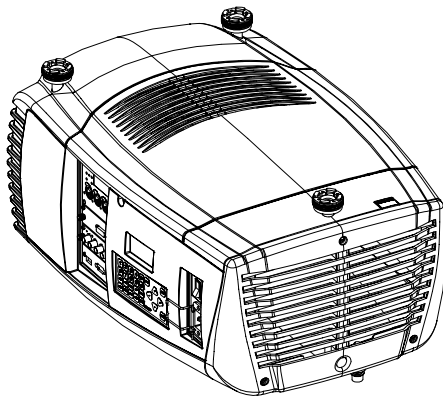

Image F-3  
Stacking points mounted

## F.2 Preparing the new carry handle

---

### What has to be done?

The back stacking point must be removed before the carry handle can be mounted on the CLM projector. The fixation hole for the fixation bolt of the carry handle is covered by the stacking point construction.

### How to remove the stacking point construction

1. Turn out the 4 bolts, 2 on each side. Be aware that there is a nut for each bolt on the inside of the carry handle.



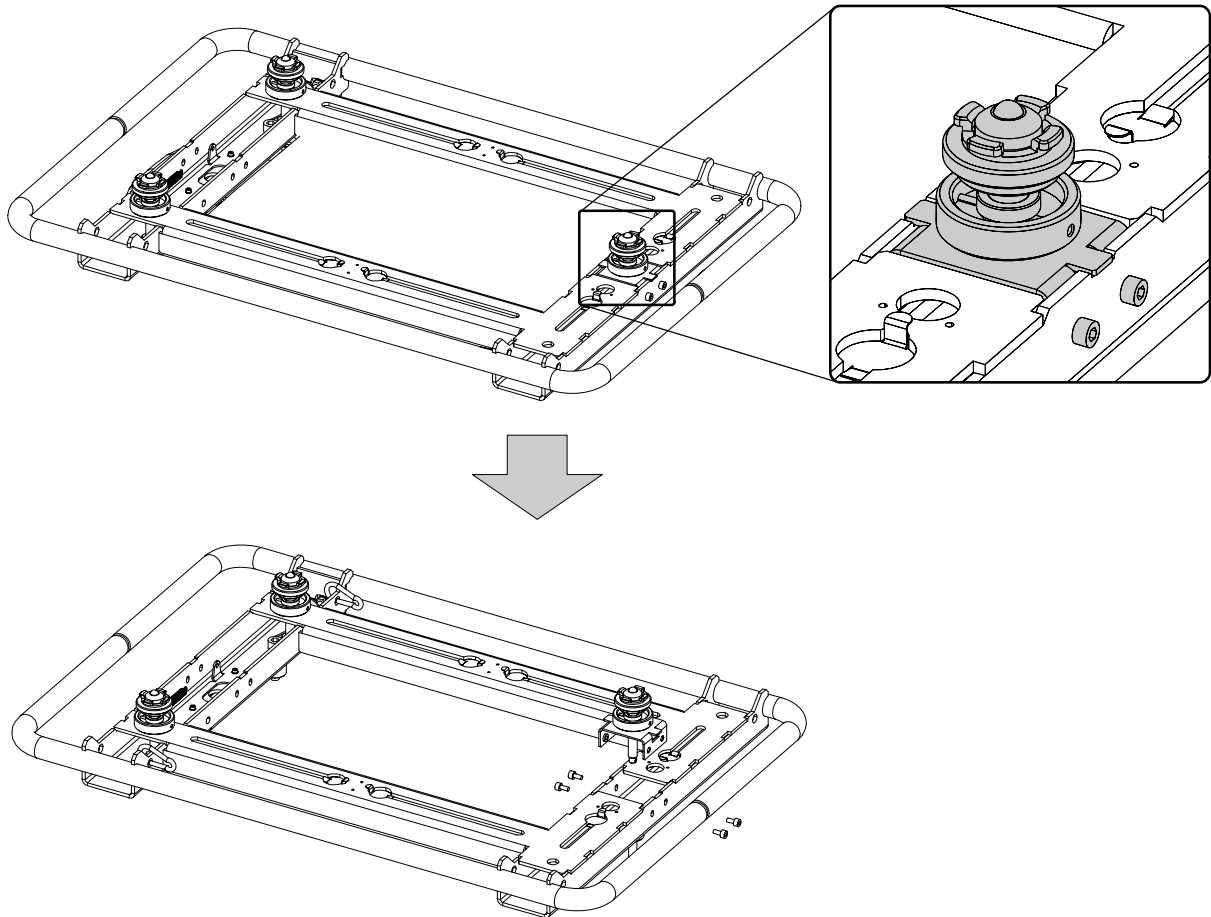

Image F-4  
Remove stacking point construction

### F.3 Preparing the projector



**CAUTION:** Before turning the projector upside down, be sure the stacking points on the top cover are mounted.

#### What has to be done?

Before the carry handle can be mounted, the projector feet must be removed and an extra support point must be added.

#### Necessary tools

- 8 mm Allen wrench.
- 22 mm open-end wrench.

#### Necessary parts

Back support point.

#### How to handle?

1. Turn the projector upside down.
2. Remove the 3 feet. First unscrew the foot cap (reference 1) and then loosen the foot adapters (reference 3). Use a 4 mm Allen wrench to unscrew the hexagon socket head cap screws (reference 2).

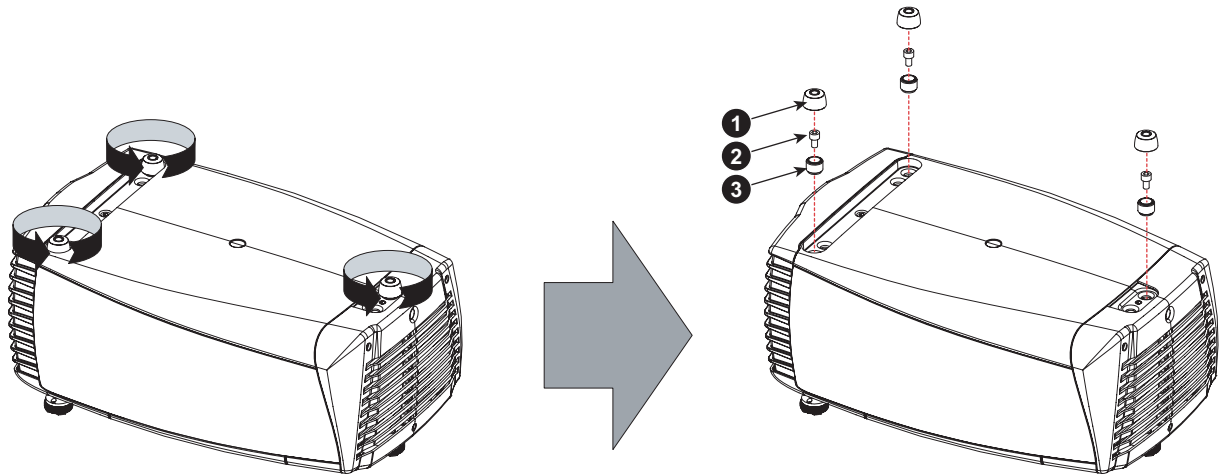

Image F-5

3. Insert next to the removed back foot the extra support point (reference 1). Use a 22mm open-end wrench to fasten the extra support.

Due to its construction, the support is still a bit movable.

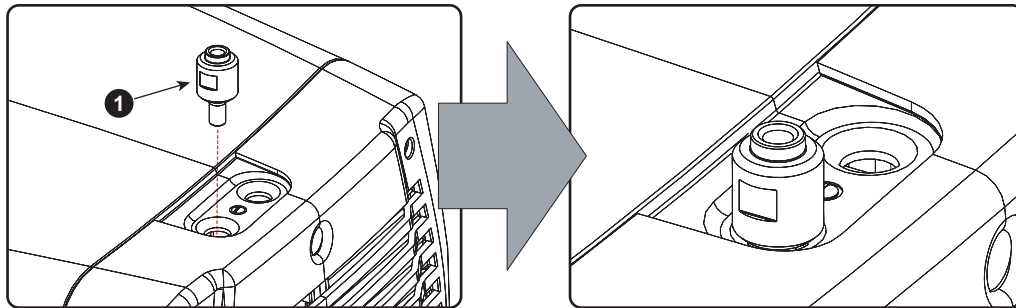

Image F-6

## F.4 Mounting the carry handle

### Necessary tools

- 8 mm Allen wrench.
- 4 mm Allen wrench.
- 2,5 mm Allen wrench.

### Necessary parts

- One spacer rotation ring.
- One flat spacer.
- One hexagon socket head cap screws M10 x 20.
- Three hexagon socket head cap screws M10 x 40.
- Four hexagon socket head cap screws M5 x 10.

### How to mount the carry handle?

1. Place the carry handle upon the bottom of the projector as illustrated.
2. Insert the spacer rotation ring (reference 4) and a hexagon socket head cap screw M10 x 40 (reference 1) in the back fixation hole so that a small rotation of the carry handle is still possible.
3. Insert a flat spacer (reference 3) and a hexagon socket head cap screw M10 x 20 (reference 2) in the fixation hole of the extra support point.
4. Insert a hexagon socket head cap screw (reference 1) into both fixation holes at the front of the carry handle.

**Note:** If both front holes are not completely free, turn on the skew adjustment (reference 5) at the right side of the carry handle until the holes are free.

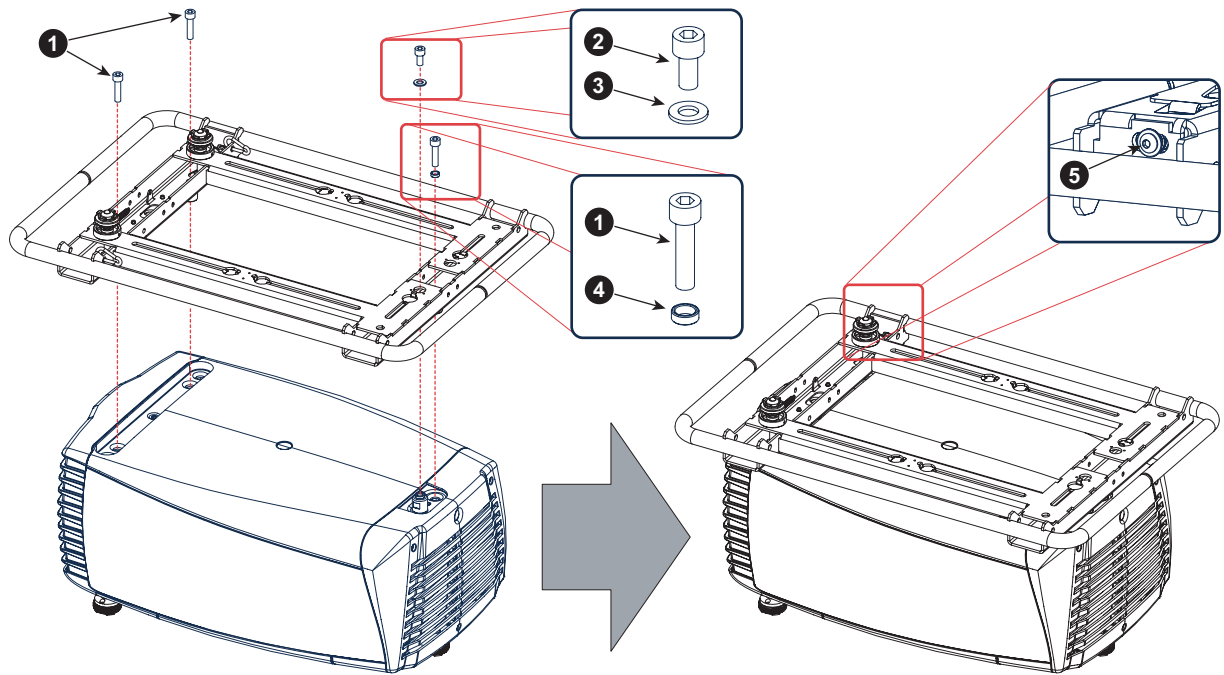

Image F-7

5. Fasten all screws (reference 1 & 2). Use a 8 mm Allen wrench.
6. Place the removed stacking point construction back on its place and secure with four hexagon socket head cap screws M5 x 10. Use a 2,5 mm Allen wrench.

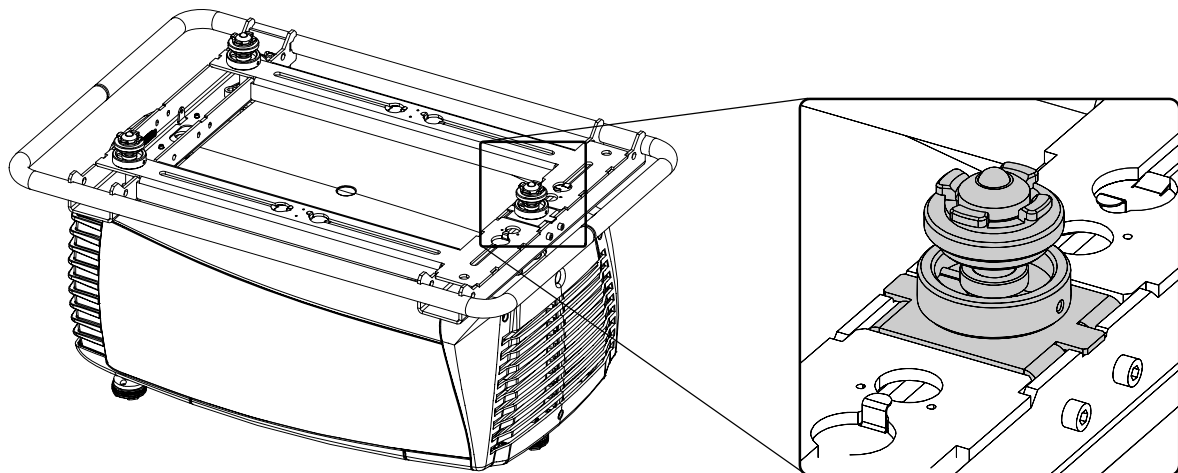

Image F-8



## G. ORDER INFO

### G.1 Spare part order info

**Order info:**

Order info	Description
R9854430	5 cable input module
R9854450	HDSDI - SDI input module
R9854460	DVI input module
R848607	Cover plate for unused input slot
R98610206	CLM dust filter kit, 6 pack
R986102012	CLM dust filter kit, 12 pack
R9861030	CLM lamp kit, single lamp
R9861040	CLM lamp kit, two lamps
R9861050	CLM lamp kit, four lamps
R9861000	Optional rigging kit for CLM + rugged remote control
R9861010	CLM flight case
R764988	CLM remote control unit
R9849870	CLD (1.2-1.6:1) zoom lens
R9861080	CLD (1.6-2.4:1) zoom lens
R9849890	CLD (2.4-4.3:1) zoom lens



---

# GLOSSARY

**2:2 pull-down**

The process of transferring 24-frames/sec film format into video by repeating each frame (used for PAL DVD's) as two video fields. ( AD )

**3:2 pull-down**

Method used to map the 24 fps of film onto the 30 fps (60 fields) or 25 fps (50 fields), so that one film frame occupies three video fields, the next two, etc. It means the two fields of every other video frame come from different film frames making operations such as rotoscoping impossible, and requiring care in editing. Some sophisticated equipment can unravel the 3:2 sequence to allow frame-by-frame treatment and subsequently re-compose 3:2. The 3:2 sequence repeats every five video frames and four film frames, the latter identified as A-D. Only film frame A is fully on a video frame and so exists at one time code only, making it the editable point of the video sequence.

**Artefacts**

Undesirable elements or defects in a video picture. These may occur naturally in the video process and must be eliminated in order to achieve a high-quality picture. Most common in analog are cross color and cross luminance. Most common in digital are macroblocks, which resemble pixelation of the video image.

**Aspect ratio**

Relation between the horizontal & vertical dimension in which the window will be displayed, e.g. 4 by 3 or 16 by 9. Can also be expressed as a decimal number, such as 1.77. The larger the ratio or decimal, the wider are less square the image.

**Color space**

A color space or color standard is a mathematical representation for a color. For example the RGB color space is based on a Cartesian coordinate system.

**Color temperature**

The coloration (reddish, white, bluish, greenish, etc.) of white in an image, measured using the Kelvin (degrees K) temperature scale. Higher temperatures output more light.

**Common address**

Projector will always execute the command coming from a RCU programmed with that common address.

**Default Gateway**

A router that serves as an entry point into and exit point out of a network. For example, a local network (LAN) may need a gateway to connect it to a wide area network (WAN) or to the Internet.

**DHCP**

Dynamic host configuration protocol. DHCP is a communications protocol that lets network administrators manage centrally and automate the assignment of IP addresses in an organization's network. Using the Internet Protocol, each machine that can connect to the Internet needs a unique IP address. When an organization sets up its computer users with a connection to the Internet, an IP address must be assigned to each machine. Without DHCP, the IP address must be entered manually at each computer and, if computers move to another location in another part of the network, a new IP address must be entered. DHCP lets a network administrator supervise and distribute IP addresses from a central point and automatically sends a new IP address when a computer is plugged into a different place in the network.

**DMX**

DMX-512 Lighting protocol over RS-485 interface. Carries information of 512 channels from a lighting controller to lighting devices. Standardized by USITT.

**HDCP**

High-bandwidth Digital Content Protection (HDCP) is a form of digital copy protection developed by Intel Corporation to protect digital audio and video content as it travels across DisplayPort, Digital Visual Interface (DVI), High-Definition Multimedia Interface (HDMI), Gigabit Video Interface (GVIF), or Unified Display Interface (UDI) connections. The specification is proprietary, and implementing HDCP requires a license.

**HEPA**

High Efficiency Particulate Absorbing

**IP**

Internet Protocol. The network layer of TCP/IP. Required for communication with the internet.

**MAC address**

Media Access Control address. Unique hardware number, used in combination with the IP-address to connect to the network (LAN or WAN).

**PiP**

PiP stands for "Picture in Picture" and allows to display multiple windows containing each of them an image. The windows may be of the video or data type.

**Projector address**

Address installed in the projector to be individually controlled.

**Qualified (service) technician**

Persons having appropriate technical training and experience necessary to be aware of hazards to which they are exposed in performing a task and of measures to minimize the danger to themselves or other persons.

**RS232**

An Electronic Industries Association (EIA) serial digital interface standard specifying the characteristics of the communication path between two devices using either D-SUB 9 pins or D-SUB 25 pins connectors. This standard is used for relatively short-range communications and does not specify balanced control lines. RS-232 is a serial control standard with a set number of conductors, data rate, word length and type of connector to be used. The standard specifies component connection standards with regard to computer interface. It is also called RS-232-C, which is the third version of the RS-232 standard, and is functionally identical to the CCITT V.24 standard. Logical '0' is  $> +3V$ , Logical '1' is  $< -3V$ . The range between  $-3V$  and  $+3V$  is the transition zone.

**RS422**

An EIA serial digital interface standard that specifies the electrical characteristics of balanced (differential) voltage, digital interface circuits. This standard is usable over longer distances than RS-232. This signal governs the asynchronous transmission of computer data at speeds of up to 920,000 bits per second. It is also used as the serial port standard for Macintosh computers. When the difference between the 2 lines is  $< -0.2V$  that equals with a logical '0'. When the difference is  $> +0.2V$  that equals to a logical '1'.

**Subnet mask**

A number that is used to identify a subnetwork so that IP addresses can be shared on a local area network.



# INDEX

## A

- Adjustment 48–50
  - Quick set up 48–50
    - Lens 48
    - Lens functions 49
    - Lens key 48
    - PIP 50
- Adjustment mode 55–56
- About 55
- LCD display menus 56
- Local keypad 55
- Navigation 56
- On screen menus 56
- RCU 55
- Start up 55
- Alignment 115–126, 128–129, 131, 135
- Blanking 119
- Color space 122
- Color standard 122
- Gamma 120
- Intensity 120
- Internal pattern 121
- Lens 117
  - Focus 117
  - Shift 117
  - Zoom 117
- Lens adjustment 117
- Orientation 116
- Overview flow 115, 135
- ScenergiX 124–126, 128–129, 131
  - Activation 125
  - Black level 131
  - Horizontal overlap 126
  - Introduction 124
  - Pattern 125
  - Preparations 125
  - Size adjustment 129
  - Vertical overlap 128
  - White level 129
- Side keystone 118
- White peaking 123
- Art-Net activation 147
- Aspect ratio 82
  - Custom 82
- Available lenses 23

## B

- Back cover 183, 186
  - Installation 186
  - Remove 183
- Background color 66
  - No signal 66
- Blanking 119
- Brightness 71
- Brilliant color look 87
- Buttons 148
  - Shortcut keys 148

## C

- Carry handle 211–214
  - Mounting 214
  - Preparation 212–213
    - Carry handle 212
    - Projector 213
- cleaning 167
  - lens 167
- Cleaning 167
  - Exterior 167
- Color saturation 72
- Color space 122

- Color standard 122
- Color temperature 76–77
  - Custom values 77
  - Predefined values 76
- Communication 39–41
  - Ethernet 41
  - IR communication 39
  - RS232 40
  - RS422 40
  - USB port 41
- Communication connections 39
- Configurations 14
  - Front projection 14
  - Rear projection 14
- Connections 35, 37, 39, 47
  - Communication connections 39
  - Input source 37
  - Power 35
  - Switching off 47
- Contrast 71
- Cooling liquid 167, 177
  - Level check 167
  - Top-up reservoir 177
- Cooling liquid circuit warning 7
- Copy 108
  - Layout 108
- Custom aspect ratio 82
- Custom color temperature 77

## D

- Delete 107
  - Layout 107
- Diagnosis 155, 157–159
  - Fan speeds 158
  - SPI 159
  - Start up 155, 157
  - Temperatures 157
- Dimensions 191
  - CLM HD8 191
- DMX 144
  - DMX address 144
  - DMX Chart 195–196
    - Basic mode 196
    - Full mode 195
  - DMX mode 147
  - DMX monitor 145
  - DMX universe 145
- Download plug-in 17
- Download Projector Toolset 17
- Dust filters 169–170
  - Replacement 169–170
    - Front side 170
    - Top side 169

## E

- Error codes 205
- Error logging 159
  - Start up 159
- Ethernet 41
- Exterior 167
  - Cleaning 167

## F

- Fan speeds 158
  - Diagnosis 158
- File services 89
  - Manual load file 89
- Film mode detection 86
- Front cover 181, 187

Installation 187  
 Removal 181  
 Front projection 14

## G

Gamma 120  
 Genera 11  
 General 12–14, 17  
   Air inlets 17  
   Air outlets 17  
   Box content 13  
   Download plug-in 17  
   Download Projector Toolset 17  
   Projector configurations 14  
   Unpacking 12  
 Getting started 43, 45, 48, 51, 53  
   Auto button 51  
   Operating projector 45  
   Projector address 51  
   Quick setup 48  
   Source selection 53  
   Terminology overview 43  
 Getting Started 43, 45, 47, 53  
   Controlling the projector 53  
   RCU & local keypad 43  
   Switching on 45  
   Using the RCU 47  
 Guidelines 8  
   Recycling 8  
   Lamp 8

## H

Hue 73

## I

Identification 113  
   Lamp 113  
 Image 69–76, 78–79, 82–84, 86–93  
   Advanced settings 84, 86–87  
     Brilliant color look 87  
     Clamp delay 84  
     Clamp width 84  
     Field polarity 84  
     Film mode detection 86  
   Aspect ratio 82  
   Brilliant color look 87  
   File services 89  
     Manual load file 89  
   Film mode detection 86  
   Image file services 88  
   Image services 88–92  
     Copy file 92  
     Delete file 89–90  
     File manipulations 88  
     File options 92  
     Files 88  
     Rename file 91  
   Image settings 70–76, 78–79  
     Brightness 71  
     Color saturation 72  
     Color temperature 76  
     Contrast 71  
     Hue 73  
     Input balance 78  
     Input balance adjusting 79  
     Noise reduction 75  
     Phase 73  
     Saturation 72  
     Sharpness 74  
     Tint 73  
   Overview flow 69  
   Save custom settings 93

Source timings 83  
 Start up 70  
 Timings 83–84  
   Advanced settings 84  
 Image file services 88  
 Image files 193  
   standard 193  
 Image menu 69  
 Image services 88–93  
   Copy file 92  
   Delete file 89–90  
   File manipulations 88  
   File options 92  
   Files 88  
   Rename file 91  
   Save custom settings 93  
 Infra red 39  
 Input 59–61, 63, 65–66  
   Configuration 60  
   Input locking 61  
   Minimum delay 63  
   Native resolution 63  
   No signal 65–66  
     Background color 66  
     Shutdown 66  
     Shutdown retarding time 66  
   Overview flow 59  
   Slot module type 59  
   Source switching 65  
 Input balance 78–81  
   Adjusting 79  
   Black balance 80  
   Introduction 78  
   White balance 81  
 Input menu 59  
 Input module 176–177  
   Inserting 177  
   Removal 176  
 Input setup 59  
   About 59  
 Input source connection 37  
 Installation 11, 19, 23–25, 29, 185–188  
   Back cover 186  
   Ceiling mount 29  
   Front cover 187  
   Lamp door 188  
   Lenses 23  
     Available 23  
   RCU 19  
   Requirements 11  
   Side cover 185  
   Suspension 25  
     Rigging clamps 25  
   Table mount 24  
   Top cover 186  
 Installation requirements 11–12  
   Ambient temperature 11  
   Clean air 11  
   Humidity 11  
   Image size 12  
   Projector weight 11  
   Screen type 12  
 Intensity 120  
 Internal pattern 121  
   Selection 121  
 IR communication 39  
 IR control 143

## K

Keystone 118

## L

Lamp 111–114

- Identification 113
  - Lamp mode 114
  - Overview 111
  - Power 112
  - Power mode 111
  - Run time overview 114
  - Status overview 114
  - Lamp door 182, 188
    - Installation 188
    - Removal 182
  - Lamp identification 113
  - Lamp mode 114
  - Lamp power mode 111
  - Lamp run time overview 114
  - Lamp status overview 114
  - Lamp unit 173, 175
    - Mounting 175
    - Removal 173
  - Language 51, 150
    - Selection 51, 150
  - Layout 95–96, 99, 101–102, 105–108
    - Copy 108
    - Delete 107
    - Layout file services 106
    - Layout services 106–108
      - Copy 108
      - Delete 107
      - Load 106
      - Rename 107
      - Save as 108
    - Load 106
    - Main window 95–96, 99
      - Position 99
      - Size 96
      - Source 96
    - Overview flow 95
    - PIP 101–102, 105
      - Activation 101
      - Position 105
      - Size 102
      - Source 101
      - Rename 107
      - Save as 108
  - LCD display menus 56
  - lens 167
    - cleaning 167
  - Lens 117
    - Focus 117
    - Shift 117
    - Zoom 117
  - Lens adjustment 117
  - Lens formulas 24
  - Lens installation 171
  - Lens removal 172
  - Lens selection 23
  - Lenses 23–24, 171–172
    - Formulas 24
    - Lens installation 171
    - Lens removal 172
    - Lens selection 23
  - Load 106
    - Layout 106
- M**
- Maintenance 167, 169–170
    - Dust filters 169–170
      - Front side 170
      - Top side 169
  - Mercury vapor warnings 7
  - Minimum delay 63
- N**
- Native resolution 63
  - Navigation 56
    - Adjustment mode 56
  - Network 139–142
    - DHCP 140
    - Gateway 142
    - Introduction 140
    - IP-address 141
    - Subnet-mask 141
  - No signal 65–66
    - Background color 66
    - Shutdown 66
    - Shutdown retarding time 66
  - Noise reduction 75
  - Notice on safety 5
- O**
- Off-Axis 15
  - On screen menus 56
  - On-Axis 15
  - Order info 217
    - Spare part 217
  - Orientations 14
    - Front projection 14
    - Rear projection 14
- P**
- Phase 73
  - PIP 100–102, 105
    - Activation 101
    - Introduction 100
    - Position 105
    - Size 102
    - Source 101
  - Position 99
    - Main window 99
  - Positioning 15
  - Power 112
  - Power connection 35
  - Preset color temperature 76
  - Prevent 6–7, 20
    - Battery explosion 7, 20
    - Electrical shock 6
    - Fire hazard 7
    - Personal injury 6
    - Projector damage 7
  - Projector 14–16
    - Configurations 14
    - Orientations 14
    - Positioning 15
    - Shift range 15
    - Tilt range 16
  - Projector address 51–52, 136–137
    - Address 136
    - Common address 137
    - Controlling 52
    - Program 51
      - RCU 51
  - Projector configurations 14
  - Projector control 135–145, 147–150
    - Art-Net activation 147
    - Buttons 148
      - APA button 148
      - Shortcut keys 148
    - DMX 144
    - DMX address 144
    - DMX mode 147
    - DMX monitor 145
    - DMX universe 145
    - IR control 143
    - Language 150
      - Selection 150
    - Local LCD contrast 150
    - Menu position 149

- Network 139–142
    - DHCP 140
    - Gateway 142
    - Introduction 140
    - IP-address 141
    - Subnet-mask 141
  - Projector address 136–137
    - Address 136
    - Common address 137
  - Serial communication 137–139
    - Baud rate setup 138
    - Interface standard 138
    - RS422 termination 139
  - Projector covers 181–182, 185–188
    - Back cover 186
      - Installation 186
    - Front cover 181, 187
      - Installation 187
      - Removal 181
    - Lamp door 182, 188
      - Installation 188
      - Removal 182
    - Side cover 185
      - Installation 185
    - Top cover 186
      - Installation 186
  - Projector status 39
- Q**
- Quick language 51
    - Selection 51
  - Quick layout 50
    - Rigging key 50
    - Selection 50
  - Quick set up 48–50
    - Lens 48–49
      - Lens functions 49
      - LENS key 48
    - PIP 50
    - Text on/off 48
  - Quick setup 19
- R**
- RCU 19, 21–22
    - Possibilities 22
    - Rugged case 21
    - XLR adaptor 21–22
  - Rear projection 14
  - Recycling 8
  - Refill mode 162
  - Remote control 20–21, 39
    - Battery 20
    - Rugged case 21
  - Remote Control 49–50
    - Lens functions 49
    - PIP 50
  - Remove 181–184
    - Back cover 183
    - Front cover 181
    - Lamp door 182
    - Side cover 184
    - Top cover 184
  - Rename 107
    - Layout 107
  - Restore factory defaults 160
  - Rigging key 50
    - Quick layout selection 50
  - RS232 40
  - RS422 40
- S**
- Safety 5–9, 20
    - Battery explosion 7, 20
    - Cooling liquid circuit 7
    - Electrical shock 6
    - Fire hazard 7
    - Flight cases 9
    - General 5
    - Instructions 6
    - Mercury vapor warnings 7
    - Personal injury 6
    - Projector damage 7
    - Replacement parts 8
    - Servicing 8
    - Ultraviolet radiation 6
    - UV radiation 6
  - Saturation 72
  - Save as 108
    - Layout 108
  - Save custom settings 161
  - ScenergiX 124–126, 128–129, 131
    - Activation 125
    - Black level 131
    - Horizontal overlap 126
    - Introduction 124
    - Pattern 125
    - Preparations 125
    - Size adjustment 129
    - Vertical overlap 128
    - White level 129
  - Serial communication 40, 137–139
    - Baud rate setup 138
    - Interface standard 138
    - RS422 termination 139
  - Service 153, 155–164
    - Diagnosis 155, 157–159
      - Fan speeds 158
      - SPI 159
      - Start up 155, 157
      - Temperatures 157
    - Error logging 159
      - Start up 159
    - Identification 153
    - Internal service patterns 160
    - Overview flow 153
    - Refill mode 162
    - Restore factory defaults 160
    - Safety 164
      - DMD safety 164
    - Save custom settings 161
    - USB memory 163
    - Versions 155
      - Start up 155
    - Voltages 156
      - Start up 156
  - Service patterns 160
    - Internal patterns 160
  - Servicing 169, 173, 175–177
    - Input module 176–177
      - Inserting 177
      - Removal 176
    - Lamp unit 173, 175
      - Mounting 175
      - Removal 173
  - Sharpness 74
  - Shift range 15
  - Shutdown, automatic 66
    - No signal 66
    - Retarding time 66
  - Side cover 184–185
    - Installation 185
    - Remove 184
  - Side keystone 118
  - Size 96
    - Main window 96
  - Source files 193
  - Source selection 53
  - Source switching 65

Source timings 83  
Specifications 199, 201–203  
  5 cable input 201  
  CLM HD8 199  
  DVI HDCP 203  
  DVI input 203  
  HDSI–SDI input 202  
SPI 159  
  Diagnosis 159  
Stacking 31, 33  
  Align projectors 33  
  Projectors 31  
Stacking points 211  
  Mounting 211  
Start up 46, 55  
  Adjustment mode 55  
  Errors and warnings 46  
Startup errors 46  
Startup warnings 46  
Switching off 47  
Switching to standby 46

## T

Temperatures 157  
  Diagnosis 157  
Text on/off 48  
Tilt range 16  
Timings 83  
Tint 73  
Top cover 184, 186

Installation 186  
  Remove 184  
Troubleshooting 205  
  Error codes 205

## U

Ultraviolet radiation 6  
Unpacking 12  
USB memory 163  
USB port 41  
UV radiation 6

## V

Versions 155  
  Start up 155  
Voltages 156  
  Start up 156

## W

Warnings 6–7  
  Cooling liquid circuit 7  
  Mercury vapor warnings 7  
  Ultraviolet radiation 6  
  UV radiation 6  
White peaking 123  
Window 100  
  PIP window 100



## Revision Sheet

To:

► **Barco nv Events/Documentation**  
Noordlaan 5, B-8520 Kuurne  
Phone: +32 56.36.82.11, Fax: +32 56.36.88.24  
E-mail: [service.mne@barco.com](mailto:service.mne@barco.com), Web: [www.barco.com](http://www.barco.com)

From: \_\_\_\_\_

Date: \_\_\_\_\_

Please correct the following points in this documentation (**R59770057/08**):

page	wrong	correct